



**MODEL:**  
**IBX-660 Series**

**4-bay Industrial Data Storage PC  
for Smart Factory and Harsh Environment**

# User Manual

# Revision

---

Date	Version	Changes
April 25, 2018	1.00	Initial release

# Copyright

---

## **COPYRIGHT NOTICE**

The information in this document is subject to change without prior notice in order to improve reliability, design and function and does not represent a commitment on the part of the manufacturer.

In no event will the manufacturer be liable for direct, indirect, special, incidental, or consequential damages arising out of the use or inability to use the product or documentation, even if advised of the possibility of such damages.

This document contains proprietary information protected by copyright. All rights are reserved. No part of this manual may be reproduced by any mechanical, electronic, or other means in any form without prior written permission of the manufacturer.

## **TRADEMARKS**

All registered trademarks and product names mentioned herein are used for identification purposes only and may be trademarks and/or registered trademarks of their respective owners.

# Manual Conventions

---



## **WARNING**

Warnings appear where overlooked details may cause damage to the equipment or result in personal injury. Warnings should be taken seriously.



## **CAUTION**

Cautionary messages should be heeded to help reduce the chance of losing data or damaging the product.



## **NOTE**

These messages inform the reader of essential but non-critical information. These messages should be read carefully as any directions or instructions contained therein can help avoid making mistakes.

# Table of Contents

<b>1 INTRODUCTION.....</b>	<b>1</b>
1.1 OVERVIEW.....	2
1.2 MODEL VARIATIONS .....	2
1.3 FEATURES.....	3
1.4 FRONT PANEL.....	3
1.5 REAR PANEL.....	4
1.6 BOTTOM SURFACE.....	5
1.7 HARDWARE SPECIFICATIONS .....	6
1.8 DIMENSIONS.....	8
<b>2 UNPACKING .....</b>	<b>9</b>
2.1 UNPACKING.....	10
2.2 PACKING LIST.....	10
2.3 OPTIONAL ITEMS .....	11
<b>3 INSTALLATION .....</b>	<b>12</b>
3.1 ANTI-STATIC PRECAUTIONS .....	13
3.2 INSTALLATION PRECAUTIONS .....	13
3.3 INSTALLATION PROCEDURE .....	14
3.4 SO-DIMM INSTALLATION (OPTIONAL).....	15
3.5 HARD DRIVE INSTALLATION.....	17
3.6 MOUNTING THE SYSTEM .....	20
3.6.1 <i>Mounting with Optional Wall Mount Kit</i> .....	20
3.7 POWER-ON PROCEDURE.....	21
3.7.1 <i>Installation Checklist</i> .....	21
3.7.2 <i>Terminal Block Pinouts</i> .....	22
3.7.3 <i>Power-on Procedure</i> .....	22
3.8 AVAILABLE DRIVERS .....	23
3.8.1 <i>Driver Download</i> .....	24
<b>4 BIOS .....</b>	<b>26</b>

4.1 INTRODUCTION.....	27
4.1.1 Starting Setup.....	27
4.1.2 Using Setup.....	27
4.1.3 Getting Help.....	28
4.1.4 BIOS Menu Bar.....	28
4.2 MAIN.....	29
4.3 ADVANCED.....	30
4.3.1 Hardware Monitor.....	31
4.3.2 CPU Configuration.....	32
4.3.3 USB Configuration.....	33
4.4 CHIPSET.....	34
4.5 SECURITY.....	36
4.6 BOOT.....	37
4.7 SAVE & EXIT.....	38
<b>5 MAINTENANCE.....</b>	<b>40</b>
5.1 COMPONENT REPLACEMENT PROCEDURE.....	41
<b>A REGULATORY COMPLIANCE.....</b>	<b>42</b>
<b>B SAFETY PRECAUTIONS.....</b>	<b>47</b>
B.1 SAFETY PRECAUTIONS.....	48
B.1.1 General Safety Precautions.....	48
B.1.2 Anti-static Precautions.....	49
B.1.3 Product Disposal.....	50
B.2 MAINTENANCE AND CLEANING PRECAUTIONS.....	50
B.2.1 Maintenance and Cleaning.....	50
B.2.2 Cleaning Tools.....	51
<b>C HAZARDOUS MATERIALS DISCLOSURE.....</b>	<b>52</b>

# List of Figures

---

Figure 1-1: IBX-660 Industrial Edge Storage Server .....	2
Figure 1-2: Front Panel .....	3
Figure 1-3: Rear Panel.....	4
Figure 1-4: Bottom Surface .....	5
Figure 1-5: Dimensions (mm/inch).....	8
Figure 3-1: Bottom Panel Removal .....	15
Figure 3-2: SO-DIMM Installation .....	16
Figure 3-3: Front Panel Removal .....	17
Figure 3-4: HDD Tray Removal.....	18
Figure 3-5: HDD Tray Installation.....	18
Figure 3-6: HDD Installation .....	19
Figure 3-7: HDD Installation .....	19
Figure 3-8: Mounting Bracket Installation.....	21
Figure 3-9: Terminal Block Pinouts .....	22
Figure 3-10: Power Button and Power Input Connector.....	22
Figure 3-11: Power LED .....	23
Figure 3-12: IEI Resource Download Center.....	23

# List of Tables

---

Table 1-1: IBX-660 Model Variations.....	2
Table 1-2: Hardware Specifications.....	7
Table 2-1: Package List.....	11
Table 4-1: BIOS Navigation Keys.....	28



Chapter

1

# Introduction

---

## 1.1 Overview



**Figure 1-1: IBX-660 Industrial Edge Storage Server**

The 4-bay compact IBX-660 is powered by an industrial-grade quad-core 1.91 GHz Intel® Atom™ E3845 processor, DDR3L RAM configurations, and two gigabit LAN ports to deliver remarkable speeds.

Engineered with a rugged steel body and no moving parts, this small form factor IBX-660 server is capable of operating under wide temperatures from -40°C to +50°C (-40°F ~ 122°F) in fanless operation. It is compliant with the military-grade MIL-STD-810G-514.6E-1 simulation test for anti-vibration.

The IBX-660 features dual power inputs that can ensure continual operation in various locations with 9 ~ 36 volts DC support. The ACC on mode is designed for vehicle applications and the use of the ACC signal can control power on/off.

## 1.2 Model Variations

The model variations of the IBX-660 are listed below.

Model No.	Pre-installed Memory
IBX-660	N/A
IBX-660-8G	8 GB DDR3L

**Table 1-1: IBX-660 Model Variations**

## IBX-660 Industrial Edge Storage Server

### 1.3 Features

The IBX-660 has the following features

- RoHS compliant design
- Fanless system
- 1.91GHz Intel® Atom™ E3845 quad-core processor
- Supports DDR3L SO-DIMM memory
- Dual GbE LAN for high speed network applications
- Support four 2.5" SSD or HDD
- Extended temperature range

### 1.4 Front Panel

The IBX-660 front panel contains six LED indicators:

- 1 x Status LED (green: power on; flashes green: sleep mode)
- 1 x LAN LED (orange: disk data is being accessed from the network)
- 4 x HDD LED

An overview of the front panel is shown in **Figure 1-2** below.



**Figure 1-2: Front Panel**

## 1.5 Rear Panel

The rear panel of the IBX-660 provides access to the following external I/O connectors.

- 1 x 12 V DC power input jack
- 1 x 9 V ~ 36 V DC power input terminal block (4-pin)
- 1 x Audio mic-in jack
- 1 x Audio out jack
- 1 x HDMI connector
- 2 x RJ-45 GbE connector
- 2 x USB 2.0 port connector
- 2 x USB 3.0 port connector
- 1 x Kensington security slot
- 1 x Power button
- 1 x ACC on/off switch

An overview of the rear panel is shown in **Figure 1-3**.

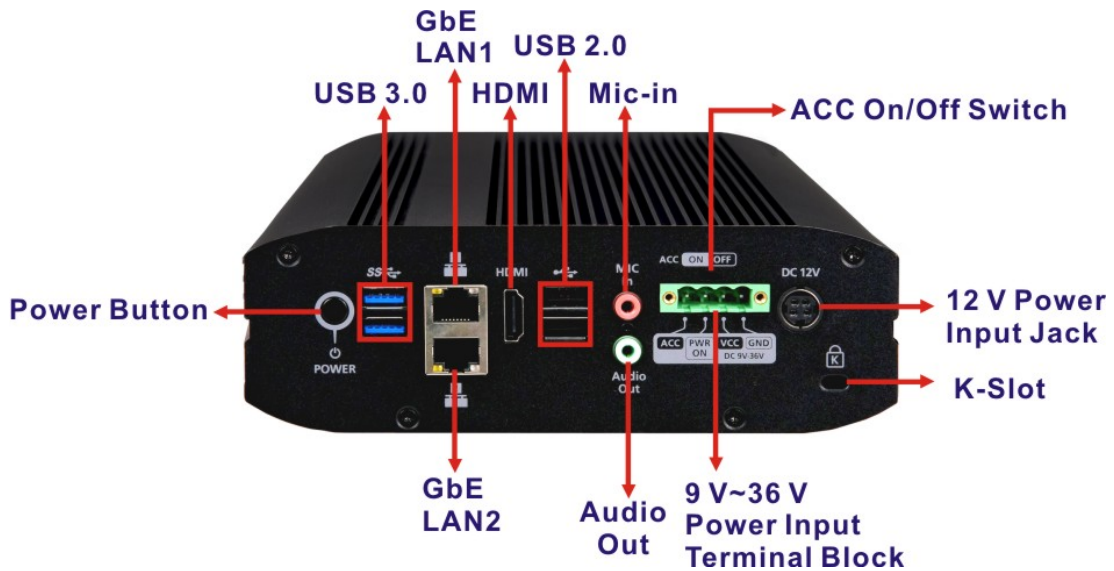

**Figure 1-3: Rear Panel**

## IBX-660 Industrial Edge Storage Server

### 1.6 Bottom Surface



#### WARNING:

Never remove the bottom access panel from the chassis while power is still being fed into the system. Before removing the bottom access panel, make sure the system has been turned off and all power connectors unplugged.

The bottom surface of the IBX-660 contains the retention screw holes for the optional wall mounting kit.

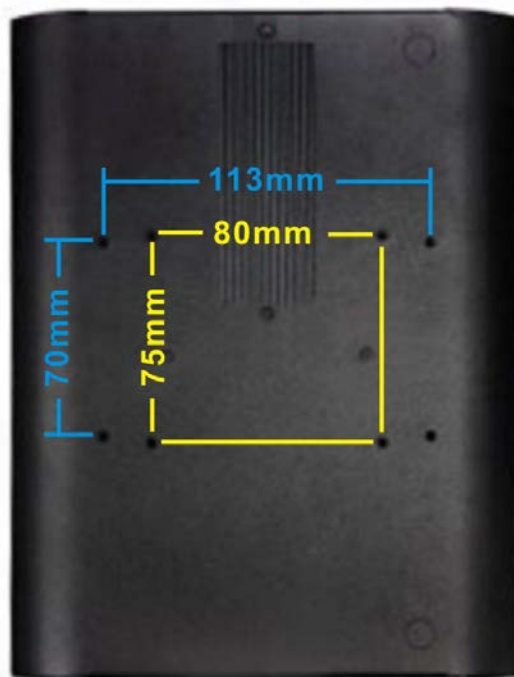

Figure 1-4: Bottom Surface

### 1.7 Hardware Specifications

The hardware specifications for the IBX-660 are listed below.

	IBX-660
<b>CPU (SoC)</b>	22nm Intel® Atom™ E3845 quad core processor (1.91 GHz)
<b>Memory Slot</b>	2 x 204-pin DDR3L SO-DIMM slots (system max. 8 GB) *IBX-660-8G model is preinstalled with 8 GB (two 4 GB) memory *For dual-DIMM configurations, you must use a pair of identical DDR3L modules.
<b>eMMC</b>	32 GB
<b>GPU</b>	7th generation Intel® HD Graphics
<b>Ethernet</b>	2 x RJ-45 gigabit Ethernet port
<b>HDD</b>	4 x 2.5" SATA SSD/HDD
<b>Display</b>	1 x HDMI port (up to 1080p)
<b>Audio</b>	1 x Mic-in 1 x Audio out jack
<b>USB</b>	2 x USB 2.0 ports 2 x USB 3.0 ports
<b>LED Indicators</b>	1 x Status LED 1 x LAN LED 4 x HDD LED
<b>Button</b>	1 x Power button
<b>Other Interface</b>	1 x Kensington Security Slot
<b>Fan</b>	Fanless design
<b>Supported OS</b>	Microsoft Windows 10 IoT Enterprise / Linux

## IBX-660 Industrial Edge Storage Server

<b>Power Supply</b>	<p><b>Power 1:</b> DC power jack, external power adaptor, 12 V, 90 W, 100 V – 240 V input</p> <p><b>Power 2:</b> 4-pin terminal block, 9 V – 36 V DC</p>
<b>Power Consumption</b>	40 W (Intel® Atom® E3845 CPU with 8 GB 1600 MHz DDR3L memory and four 2.5" HDD)
<b>Operating Temperature</b>	<p>-40°C ~ 50°C (-40°F ~ 122°F)</p> <p>Please note that industrial SSDs are required to meet this condition.</p>
<b>Humidity</b>	5% – 95% RH non-condensing
<b>Color</b>	Black
<b>Mounting</b>	Wall mount with optional mounting kit
<b>Weight</b>	<p>Net weight: 1.11 kg (2.45 lbs)</p> <p>Gross weight: 3.2 kg (7.05 lbs)</p>
<b>Dimensions</b>	<p>59 (H) x 180 (W) x 247 (D) mm</p> <p>2.32 (H) x 7.09 (W) x 9.72 (D) inch</p>
<b>EMC</b>	FCC, CE

**Table 1-2: Hardware Specifications**

### 1.8 Dimensions

The dimensions of the IBX-660 are listed below and shown in **Figure 1-5**.

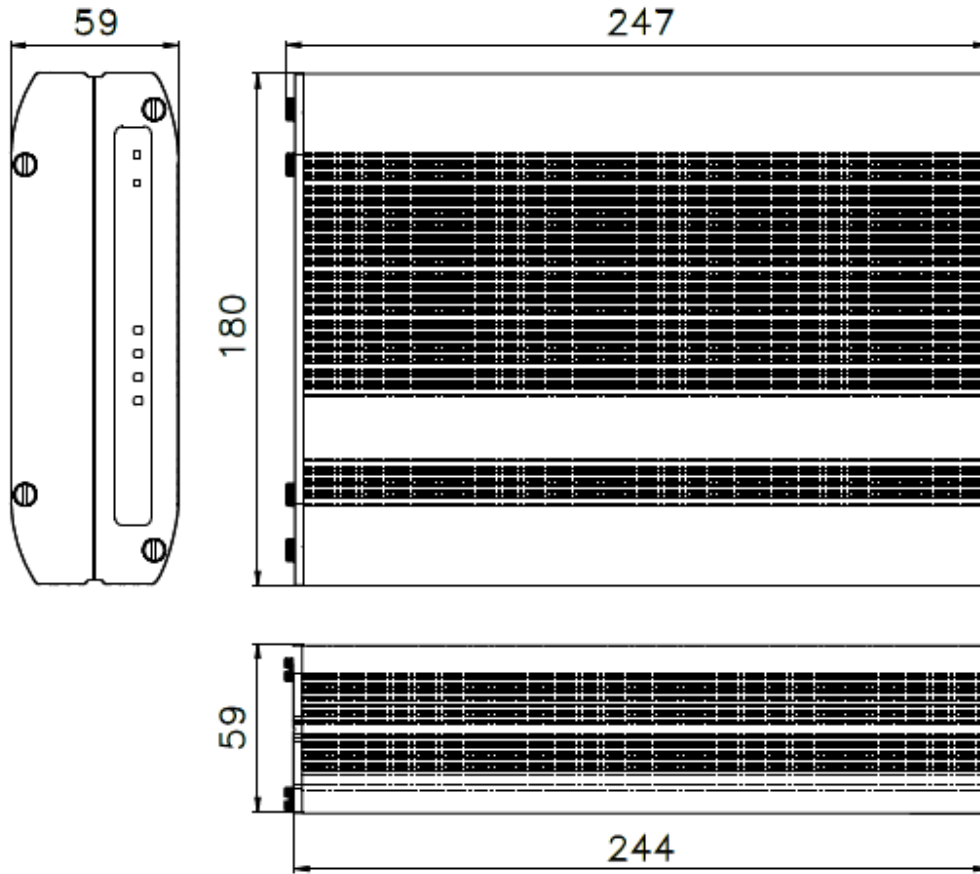

**Figure 1-5: Dimensions (mm/inch)**



Chapter

2

# Unpacking

---

## 2.1 Unpacking

To unpack the IBX-660, follow the steps below:

- Step 1:** Use box cutters, a knife or a sharp pair of scissors that seals the top side of the external (second) box.
- Step 2:** Open the external (second) box.
- Step 3:** Use box cutters, a knife or a sharp pair of scissors that seals the top side of the internal (first) box.
- Step 4:** Lift the system out of the boxes.
- Step 5:** Remove both polystyrene ends, one from each side.
- Step 6:** Make sure all the components listed in the packing list are present.

## 2.2 Packing List







**NOTE:**

If any of the components listed in the checklist below are missing, do not proceed with the installation. Contact the IEI reseller or vendor the IBX-660 was purchased from or contact an IEI sales representative directly by sending an email to [sales@ieiworld.com](mailto:sales@ieiworld.com).

The IBX-660 is shipped with the following components:

Quantity	Item	Image
1	IBX-660 industrial edge storage server	

## IBX-660 Industrial Edge Storage Server

2	Ethernet cable	
1	AC power adapter	
1	Power cord	
24	Flat head screws for HDD installation	

**Table 2-1: Package List**

### 2.3 Optional Items

The following are optional components which may be separately purchased:

Item and Part Number	Image
OS Image with Windows 10 IoT Enterprise Entry 64-bit for IBX-660 series, with DVD-ROM, RoHS (P/N: IBX-660-W10E64-E-R10)	

Chapter

**3**

# Installation

---

## IBX-660 Industrial Edge Storage Server

### 3.1 Anti-static Precautions

---



#### **WARNING:**

Failure to take ESD precautions during the maintenance of the IBX-660 may result in permanent damage to the IBX-660 and severe injury to the user.

---

Electrostatic discharge (ESD) can cause serious damage to electronic components, including the WAFER series motherboard and the power module. (Dry climates are especially susceptible to ESD.) It is therefore critical that whenever the IBX-660 is opened and any electrical component handled, the following anti-static precautions are strictly adhered to.

- ***Wear an anti-static wristband:*** Wearing a simple anti-static wristband can help to prevent ESD from damaging the board.
- ***Self-grounding:*** Before handling the board, touch any grounded conducting material. During the time the board is handled, frequently touch any conducting materials that are connected to the ground.
- ***Use an anti-static pad:*** When configuring the IBX-660, place it on an anti-static pad. This reduces the possibility of ESD damaging the IBX-660.

### 3.2 Installation Precautions

---



#### **CAUTION:**

The IBX-660 series has more than one power supply connection point.

To reduce the risk of electric shock, disconnect all power sources before installing or servicing the IBX-660 series.

---

During installation, be aware of the precautions below:

- **Read the user manual:** The user manual provides a complete description of the IBX-660, installation instructions and configuration options.
- **DANGER! Disconnect Power:** Power to the IBX-660 must be disconnected during the installation process. Failing to disconnect the power may cause severe injury to the body and/or damage to the system.
- **Qualified Personnel:** The IBX-660 must be installed and operated only by trained and qualified personnel. Maintenance, upgrades, or repairs may only be carried out by qualified personnel who are familiar with the associated dangers.
- **Air Circulation:** Make sure there is sufficient air circulation when installing the IBX-660. The IBX-660's cooling vents must not be obstructed by any objects. Blocking the vents can cause overheating of the IBX-660. Leave at least 5 cm of clearance around the IBX-660 to prevent overheating.
- **Grounding:** The IBX-660 should be properly grounded. The voltage feeds must not be overloaded. Adjust the cabling and provide external overcharge protection per the electrical values indicated on the label attached to the back of the IBX-660.

### 3.3 Installation Procedure

To properly install the IBX-660, the following steps must be followed. Detailed descriptions of these instructions are listed in the sections that follow.

**Step 1:** Unpacking

**Step 2:** Install memory module (optional)

**Step 3:** Install the hard disk drive (HDD)

**Step 4:** Mount the IBX-660

**Step 5:** Connect the Ethernet cable

**Step 6:** Connect peripheral devices

**Step 7:** Power the system up **Step 0:**

## IBX-660 Industrial Edge Storage Server

### 3.4 SO-DIMM Installation (Optional)



#### WARNING:

Using incorrectly specified SO-DIMM may cause permanently damage the IBX-660. Please make sure the purchased SO-DIMM complies with the memory specifications of the IBX-660.

To install a SO-DIMM memory module into a SO-DIMM socket, please follow the steps below.

- Step 1:** Loosen the four captive screws on the front panel to remove the front panel. Remove the four screws on the bottom and two screws on the rear panel. Lift the bottom panel off.



Figure 3-1: Bottom Panel Removal

**Step 2:** Slide the memory module to the slot at a 45-degree angle (approximately) and press the memory module down until it clips into place. Ensure the memory module sits properly with the clips in place.



**Figure 3-2: SO-DIMM Installation**



**NOTE:**

Always ensure that a memory module is installed in the primary slot that is on the top (marked with “DIMM1”). If not, then the system will fail to start. When installing two memory modules, please ensure that they are the same size and ideally use the same type/model for both slots.





## IBX-660 Industrial Edge Storage Server

**Step 3:** Close the bottom cover and fasten the screws (refer to **Step 1** for screw positions).

### 3.5 Hard Drive Installation



#### NOTE:

Before installing hard drives, ensure the solid disk drives (SSDs) that you use are compatible with the IBX-660.

Four 2.5" SATA hard drives and/or solid disk drive (SSD) can be installed in the IBX-660. To install the hard drive into the system, please follow the steps below.

**Step 1:** Remove all four screws from the front panel (Figure 3-3).

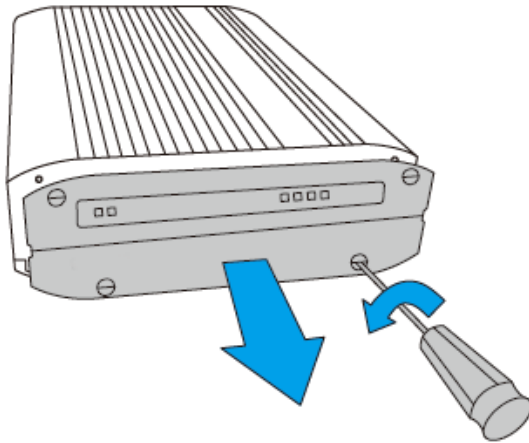

**Figure 3-3: Front Panel Removal**

**Step 2:** Remove the hard drive tray (Figure 3-4).

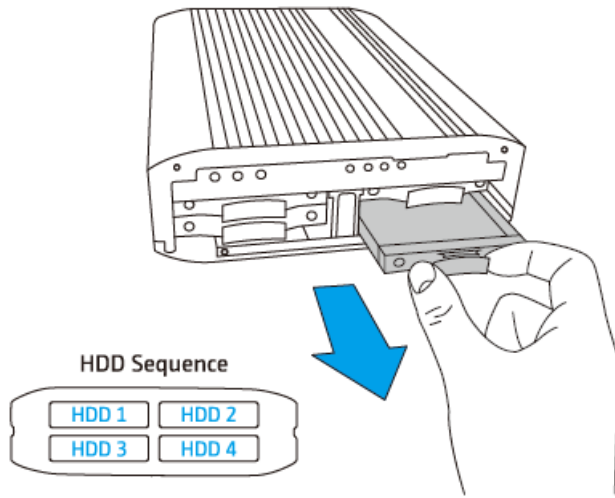

**Figure 3-4: HDD Tray Removal**

**Step 3:** Attach the drive to the tray and secure the four screws in the back of the drive tray (Figure 3-5).

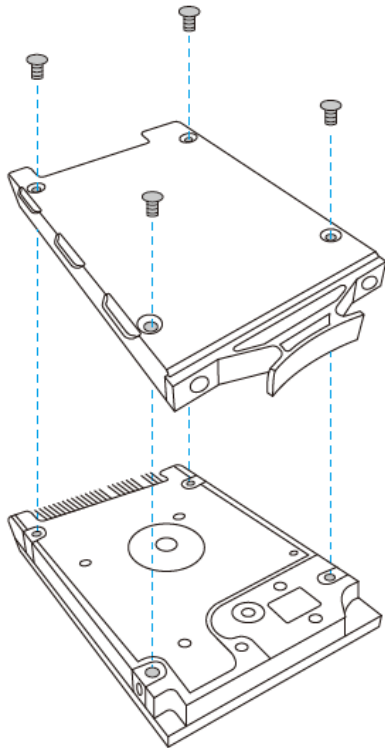

**Figure 3-5: HDD Tray Installation**

## IBX-660 Industrial Edge Storage Server

**Step 4:** Insert the drive tray into the IBX-660 all the way to the end (**Figure 3-6**).

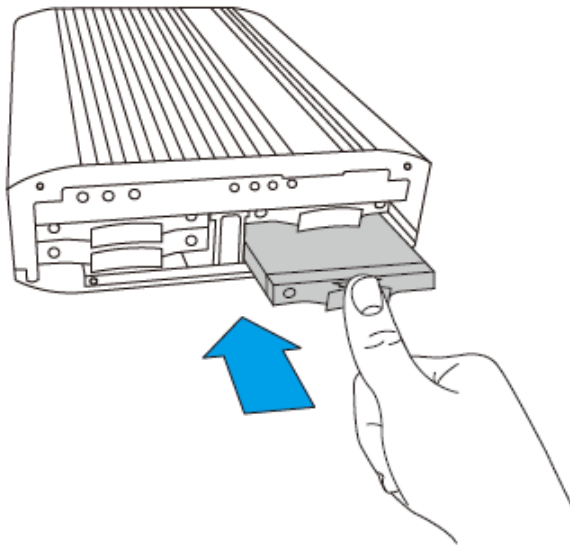

**Figure 3-6: HDD Installation**

**Step 5:** Repeat **Step 2** to **Step 4** to install the remaining drives. Please follow the HDD Sequence shown in **Step 2** to do so.

**Step 6:** Close the front panel and fasten the screws (**Figure 3-7**).

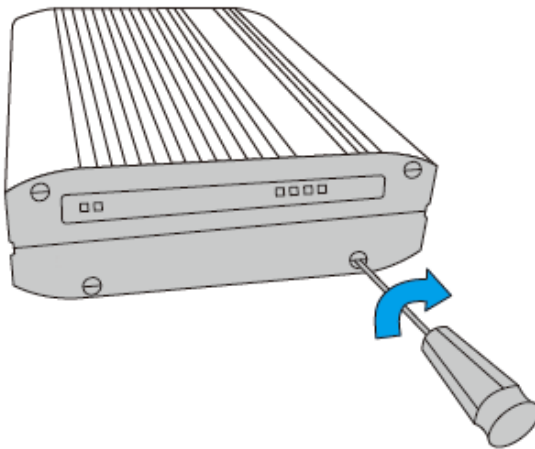

**Figure 3-7: HDD Installation**

**WARNING:**

Users are strongly recommended to turn OFF the IBX-660 before replacing the hard drive to reduce the risk of electric shock.

---

**CAUTION:**

IEI disclaims any responsibility for product damage/malfunction or data loss/recovery due to misuse or improper installation of hard disks in any occasions for any reasons.

---

## 3.6 Mounting the System

Mounting instructions of the IBX-660 are given in the following sections. The mounting kit described below can be separately purchased. Please contact IEI sales representative directly for detail information. The mounting instructions are described below.

### 3.6.1 Mounting with Optional Wall Mount Kit

To mount the IBX-660 onto a wall or some other surface using the optional wall mount kit, please follow the steps below.

**Step 1:** Turn the IBX-660 over.

**Step 2:** Align the two retention screw holes in each bracket with the corresponding retention screw holes on the bottom surface.

**Step 3:** Secure the brackets to the system by inserting two retention screws into each bracket (**Figure 3-8**).

## IBX-660 Industrial Edge Storage Server

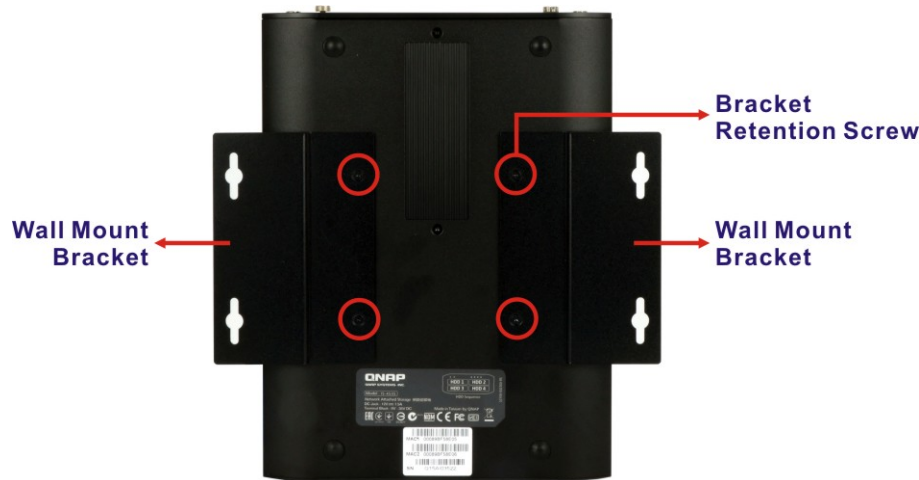

**Figure 3-8: Mounting Bracket Installation**

**Step 4:** Drill holes in the intended installation surface.

**Step 5:** Align the mounting holes in the sides of the mounting brackets with the predrilled holes in the mounting surface.

**Step 6:** Insert four retention screws, two in each bracket, to secure the system to the wall.

## 3.7 Power-On Procedure

### 3.7.1 Installation Checklist



#### **WARNING:**

Make sure a power supply with the correct input voltage is being fed into the system. Incorrect voltages applied to the system may cause damage to the internal electronic components and may also cause injury to the user.

To power on the IBX-660, please make sure of the following:

- The HDD/SSD is installed
- The LAN cable is connected
- The power cables are plugged in

- The system is securely mounted

### 3.7.2 Terminal Block Pinouts

The IBX-660 has a 9 V – 36 V power input terminal block. The terminal block pinouts are shown in **Figure 3-9**.

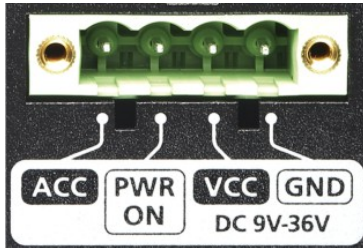
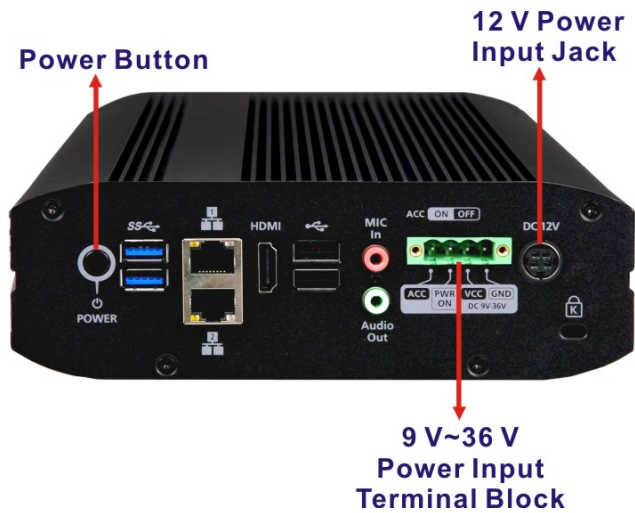

**Figure 3-9: Terminal Block Pinouts**

### 3.7.3 Power-on Procedure

To power-on the IBX-660 please follow the steps below:

- Step 1:** Connect the power source to the power input jack or the power input terminal block.
- Step 2:** Push the power button (Figure 3-11).



**Figure 3-10: Power Button and Power Input Connector**

## IBX-660 Industrial Edge Storage Server

**Step 3:** Once turned on, the status LED indicator should turn to green (Figure 3-11).



**Figure 3-11: Power LED**

**Step 4:** To turn off the IBX-660, press the power button for 1.5 seconds.

To force turn off, press the power button for 5 seconds.

### 3.8 Available Drivers

All the drivers for the IBX-660 are available on IEI Resource Download Center (<https://download.ieiworld.com>). Type IBX-660 and press Enter to find all the relevant software, utilities, and documentation.

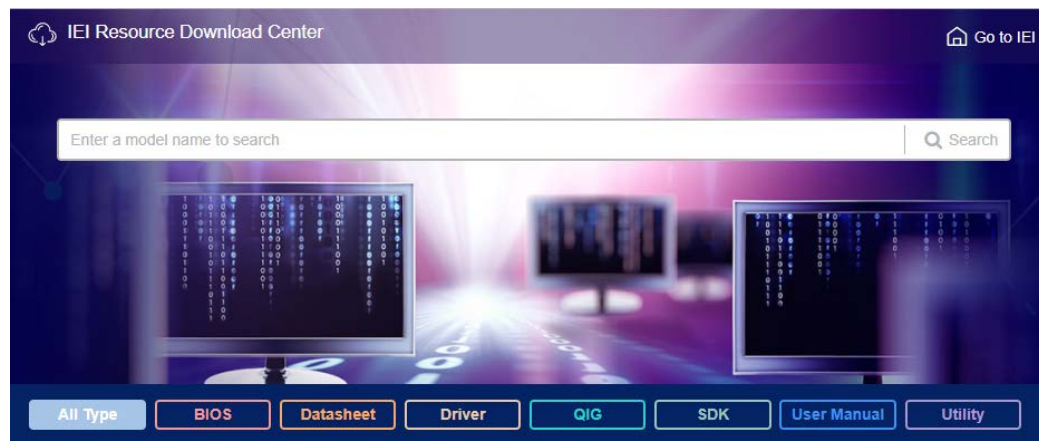

**Figure 3-12: IEI Resource Download Center**

## 3.8.1 Driver Download

To download drivers from IEI Resource Download Center, follow the steps below.

**Step 1:** Go to <https://download.ieiworld.com>. Type IBX-660IBX-660IBX-660 and press Enter.



**Step 2:** All product-related software, utilities, and documentation will be listed. You can choose **Driver** to filter the result.

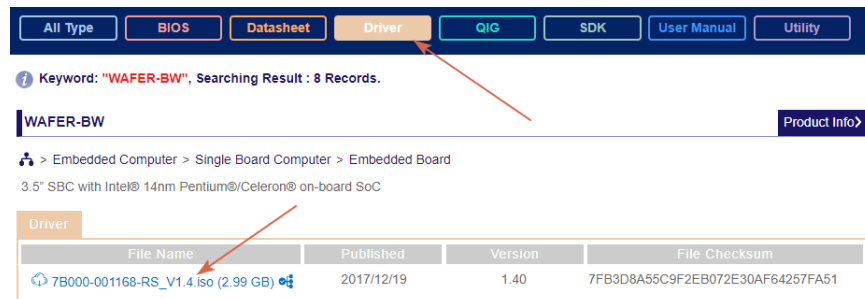

**Step 3:** Click the driver file name on the page and you will be prompted with the following window. You can download the entire ISO file (❶), or click the small arrow to find an individual driver and click the file name to download (❷).

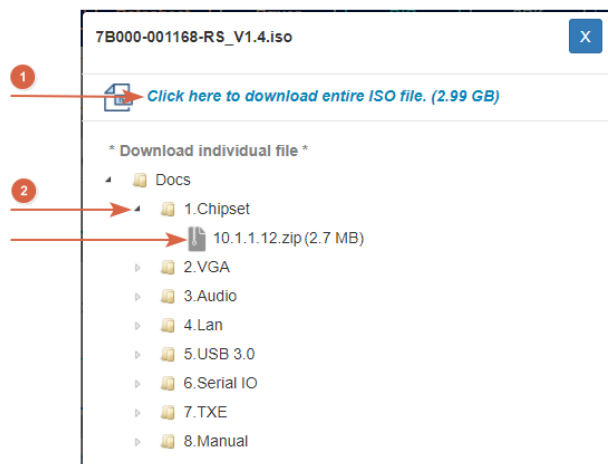



**NOTE:**

To install software from the downloaded ISO image file in Windows 8, 8.1 or 10, double-click the ISO file to mount it as a virtual drive to view its content. On Windows 7 system, an additional tool (such as Virtual CD-ROM Control Panel from Microsoft) is needed to mount the file.

---

Chapter

4

# BIOS

---

## IBX-660 Industrial Edge Storage Server

### 4.1 Introduction

The BIOS is programmed onto the BIOS chip. The BIOS setup program allows changes to certain system settings. This chapter outlines the options that can be changed.



#### NOTE:

Some of the BIOS options may vary throughout the life cycle of the product and are subject to change without prior notice.

---

#### 4.1.1 Starting Setup

The UEFI BIOS is activated when the computer is turned on. The setup program can be activated in one of two ways.

1. Press the **DELETE** key as soon as the system is turned on or
2. Press the **DELETE** key when the “**Press Delete to enter SETUP**” message appears on the screen.

If the message disappears before the **DELETE** key is pressed, restart the computer and try again.

#### 4.1.2 Using Setup

Use the arrow keys to highlight items, press **ENTER** to select, use the PageUp and PageDown keys to change entries, press **F1** for help and press **ESC** to quit. Navigation keys are shown in.

Key	Function
Up arrow	Move to the item above
Down arrow	Move to the item below
Left arrow	Move to the item on the left hand side
Right arrow	Move to the item on the right hand side
+	Increase the numeric value or make changes

Key	Function
-	Decrease the numeric value or make changes
Page up	Move to the next page
Page down	Move to the previous page
Esc	Main Menu – Quit and do not save changes into CMOS Status Page Setup Menu and Option Page Setup Menu -- Exit current page and return to Main Menu
F1 key	General help, only for Status Page Setup Menu and Option Page Setup Menu
F2 key	Load previous values
F3 key	Load optimized defaults
F4 key	Save changes and Exit BIOS

**Table 4-1: BIOS Navigation Keys**

### 4.1.3 Getting Help

When **F1** is pressed a small help window describing the appropriate keys to use and the possible selections for the highlighted item appears. To exit the Help Window press **Esc** or the **F1** key again.

### 4.1.4 BIOS Menu Bar

The **menu bar** on top of the BIOS screen has the following main items:

- Main – Changes the basic system configuration.
- Advanced – Changes the advanced system settings.
- Chipset – Changes the chipset settings.
- Security – Sets User and Supervisor Passwords.
- Boot – Changes the system boot configuration.
- Save & Exit – Selects exit options and loads default settings

The following sections completely describe the configuration options found in the menu items at the top of the BIOS screen and listed above.

## IBX-660 Industrial Edge Storage Server

### 4.2 Main

The **Main** BIOS menu (**BIOS Menu 1**) appears when the **BIOS Setup** program is entered.

The **Main** menu gives an overview of the basic system information.

Aptio Setup Utility - Copyright (C) 2013 American Megatrends, Inc.		
Main	Advanced	Chipset Security Boot Save & Exit
BIOS Information		Set the Date. Use Tab to switch between Data elements.
BIOS Vendor	American Megatrends	
Core Version	5.010	
Compliance	UEFI 2.4; PI 1.3	
Project Version	Z512AR10 x64	
Build Date and Time	04/11/2018 11:12:02	
-----		
Memory Information		→←: Select Screen
Total Memory	8192 MB	↑ ↓: Select Item
Memory Frequency	1333 MHz	Enter: Select
System Date	[Mon 08/17/2015]	+/-: Change Opt.
System Time	[11:10:27]	F1: General Help
Access Level	Administrator	F2: Previous Values
		F3: Optimized Defaults
		F4: Save & Exit
		ESC: Exit
Version 2.16.1242. Copyright (C) 2013 American Megatrends, Inc.		

#### BIOS Menu 1: Main

The **Main** menu has two user configurable fields:

#### → System Date [xx/xx/xx]

Use the **System Date** option to set the system date. Manually enter the day, month and year.

#### → System Time [xx:xx:xx]

Use the **System Time** option to set the system time. Manually enter the hours, minutes and seconds.

## 4.3 Advanced

Use the **Advanced** menu (**BIOS Menu 2**) to configure the CPU and peripheral devices through the following sub-menus:

```
Aptio Setup Utility - Copyright (C) 2013 American Megatrends, Inc.
Main  Advanced  Chipset  Security  Boot  Save & Exit
-----
> Hardware Monitor
> CPU Configuration
> USB Configuration

Monitor hardware status

-----

-><: Select Screen
↑↓: Select Item
Enter: Select
+/-: Change Opt.
F1: General Help
F2: Previous Values
F3: Optimized Defaults
F4: Save & Exit
ESC: Exit

Version 2.16.1242. Copyright (C) 2013 American Megatrends, Inc.
```

**BIOS Menu 2: Advanced**

## IBX-660 Industrial Edge Storage Server

### 4.3.1 Hardware Monitor

The **Hardware Monitor** menu (**BIOS Menu 3**) displays operating temperature and voltage.

```

Aptio Setup Utility - Copyright (C) 2013 American Megatrends, Inc.
-----
Advanced
-----
PC Health Status
CPU Temperature           : +25 C
VIN1                      : +0.984 V
VIN2                      : +2.128 V
VIN3                      : +0.992 V
VIN4                      : +3.386 V
VCC3V                     : +3.328 V
VSB3V                     : +3.344 V
VSB5V                     : +5.040 V
VBAT                      : +2.992 V

-----
-><: Select Screen
↑↓: Select Item
Enter: Select
+/-: Change Opt.
F1: General Help
F2: Previous Values
F3: Optimized Defaults
F4: Save & Exit
ESC: Exit
-----
Version 2.16.1242. Copyright (C) 2013 American Megatrends, Inc.
  
```

**BIOS Menu 3: Hardware Monitor**

### 4.3.2 CPU Configuration

Use the **CPU Configuration** menu (**BIOS Menu 4**) to view detailed CPU specifications.

```

Aptio Setup Utility - Copyright (C) 2013 American Megatrends, Inc.
-----
Advanced
-----
CPU Configuration

Intel(R) Atom(TM) CPU E3845 @ 1.91GHz
CPU Signature                30679
Microcode Patch              90a
Max CPU Speed                1910 MHz
Min CPU Speed                500 MHz
Processor Cores              4
Intel HT Technology          Not Supported
Intel VT-x Technology        Supported

L1 Data Cache                24 KB x 4
L1 Code Cache                32 KB x 4
L2 Cache                     1024 KB x 2
L3 Cache                     Not Present

-----
-><: Select Screen
↑↓: Select Item
Enter: Select
+/-: Change Opt.
F1: General Help
F2: Previous Values
F3: Optimized Defaults
F4: Save & Exit
ESC: Exit
-----
Version 2.16.1242. Copyright (C) 2013 American Megatrends, Inc.

```

#### BIOS Menu 4: CPU Configuration

The CPU Configuration menu (**BIOS Menu 4**) lists the following CPU details:

- CPU Signature: Lists the CPU signature value.
- Microcode Patch: Lists the microcode patch being used.
- Max CPU Speed: Lists the maximum CPU processing speed.
- Min CPU Speed: Lists the minimum CPU processing speed.
- Processor Cores: Lists the number of the processor core
- Intel HT Technology: Indicates if Intel HT Technology is supported by the CPU.
- Intel VT-x Technology: Indicates if Intel VT-x Technology is supported by the CPU.
- L1 Data Cache: Lists the amount of data storage space on the L1 cache.
- L1 Code Cache: Lists the amount of code storage space on the L1 cache.
- L2 Cache: Lists the amount of storage space on the L2 cache.
- L3 Cache: Lists the amount of storage space on the L3 cache.



## IBX-660 Industrial Edge Storage Server

### 4.3.3 USB Configuration

Use the **USB Configuration** menu (**BIOS Menu 5**) to read USB configuration information.

```
Aptio Setup Utility - Copyright (C) 2013 American Megatrends, Inc.
  Advanced
USB Configuration
USB Module Version          8.11.02
USB Devices:
  1 Keyboard, 2 Hubs
-----
-><: Select Screen
↑↓: Select Item
Enter: Select
+/-: Change Opt.
F1: General Help
F2: Previous Values
F3: Optimized Defaults
F4: Save & Exit
ESC: Exit
Version 2.16.1242. Copyright (C) 2013 American Megatrends, Inc.
```

#### BIOS Menu 5: USB Configuration

##### → USB Devices

The **USB Devices** field lists the USB devices that are enabled on the system

## 4.4 Chipset

Use the **Chipset** menu (**BIOS Menu 6**) to configure chipset component options.

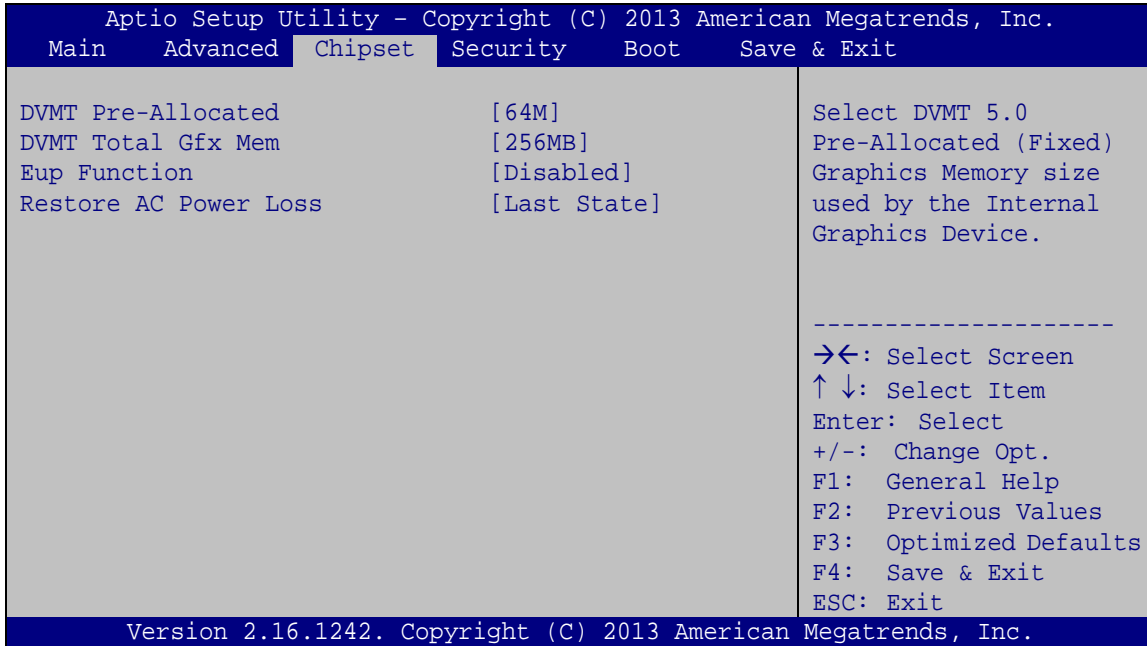

### BIOS Menu 6: Chipset

#### → DVMT Pre-Allocated [64M]

Use the **DVMT Pre-Allocated** option to specify the amount of system memory that can be used by the internal graphics device.

- 64M                    **Default**
- 96M
- 128M
- 160M
- 192M
- 224M
- 256M
- 288M
- 320M
- 352M
- 384M
- 416M

## IBX-660 Industrial Edge Storage Server

- 448M

### → DVMT Total Gfx Mem [Max]

Use the **DVMT Total Gfx Mem** option to specify the maximum amount of memory that can be allocated as graphics memory. Configuration options are listed below.

- 128MB
- 256MB                   **Default**
- Max

### → Eup Function [Disabled]

Use the **Eup Function** BIOS option to enable or disable power saving function.

- **Disabled**      **DEFAULT**      Eup Function support disabled
- **Enabled**                              Eup Function support enabled

### → Restore on AC Power Loss [Last State]

Use the **Restore on AC Power Loss** BIOS option to specify what state the system returns to if there is a sudden loss of power to the system.

- **Last State**      **DEFAULT**      The system returns to its previous state. If it was on, it turns itself on. If it was off, it remains off.
- **Power On**                              The system turns on
- **Power Off**                              The system remains turned off

## 4.5 Security

Use the **Security** menu (**BIOS Menu 7**) to set system and user passwords.

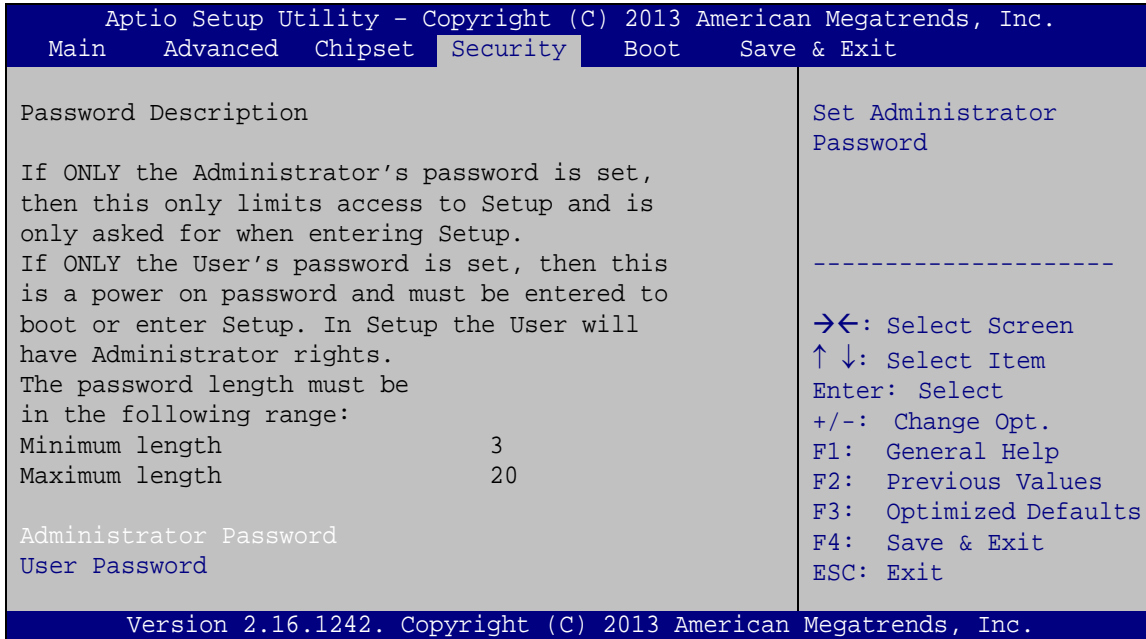

### BIOS Menu 7: Security

#### → Administrator Password

Use the **Administrator Password** to set or change an administrator password.

#### → User Password

Use the **User Password** to set or change a user password.

## IBX-660 Industrial Edge Storage Server

### 4.6 Boot

Use the **Boot** menu (**BIOS Menu 8**) to configure system boot options.

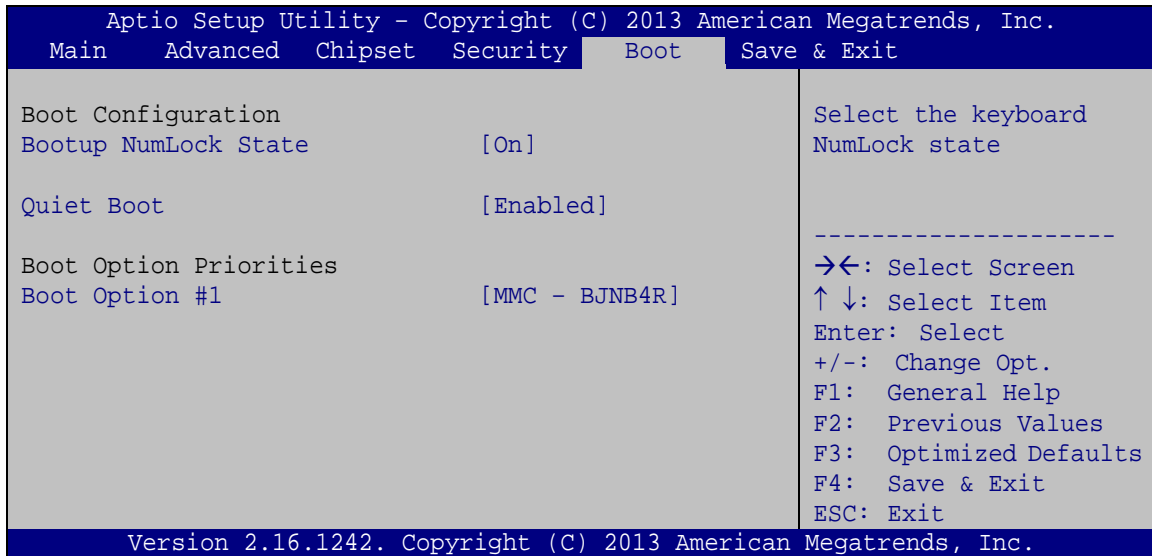

#### BIOS Menu 8: Boot

##### → Bootup NumLock State [On]

Use the **Bootup NumLock State** BIOS option to specify if the number lock setting must be modified during boot up.

→ **On**                      **DEFAULT**                      Allows the Number Lock on the keyboard to be enabled automatically when the computer system boots up. This allows the immediate use of the 10-key numeric keypad located on the right side of the keyboard. To confirm this, the Number Lock LED light on the keyboard is lit.

→ **Off**                                      Does not enable the keyboard Number Lock automatically. To use the 10-keys on the keyboard, press the Number Lock key located on the upper left-hand corner of the 10-key pad. The Number Lock LED on the keyboard lights up when the Number Lock is engaged.

### → Quiet Boot [Enabled]

Use the **Quiet Boot** BIOS option to select the screen display when the system boots.

- **Disabled** Normal POST messages displayed
- **Enabled** **DEFAULT** OEM Logo displayed instead of POST messages

## 4.7 Save & Exit

Use the **Save & Exit** menu (**BIOS Menu 9**) to load default BIOS values, optimal failsafe values and to save configuration changes.

```

Aptio Setup Utility - Copyright (C) 2013 American Megatrends, Inc.
Main   Advanced  Chipset  Security  Boot   Save& Exit
-----
Save Changes and Reset
Discard Changes and Reset

Restore Defaults
Save as User Defaults
Restore User Defaults

Exit the system after
saving the changes.

-----
→←: Select Screen
↑ ↓: Select Item
Enter: Select
+/-: Change Opt.
F1:  General Help
F2:  Previous Values
F3:  Optimized Defaults
F4:  Save & Exit
ESC: Exit

Version 2.16.1242. Copyright (C) 2013 American Megatrends, Inc.
    
```

### BIOS Menu 9: Save & Exit

#### → Save Changes and Reset

Use the **Save Changes and Reset** option to save the changes made to the BIOS options and reset the system.

#### → Discard Changes and Reset

Use the **Discard Changes and Reset** option to exit the system without saving the changes made to the BIOS configuration setup program.

## IBX-660 Industrial Edge Storage Server

### → Restore Defaults

Use the **Restore Defaults** option to load the optimal default values for each of the parameters on the Setup menus. **F3 key can be used for this operation.**

### → Save as User Defaults

Use the **Save as User Defaults** option to save the changes done so far as user defaults.

### → Restore User Defaults

Use the **Restore User Defaults** option to restore the user defaults to all the setup options.

Chapter

**5**

# Maintenance

---



## IBX-660 Industrial Edge Storage Server

---



### WARNING:

The following instructions should only be performed by an authorized and trained technician.

Before starting, please ensure that you turn off the IBX-660, disconnect the power adaptor, network cable(s), and also remove any other device/cable that is attached to the server.

Take Anti-Static precautions whenever maintenance is being carried out on the system components. Failure to take anti-static precautions can cause permanent system damage. For more details on anti-static precautions, please refer to **Section 3.1**.

---

## 5.1 Component Replacement Procedure

---



### WARNING!

Users are not advised to attempt to repair or replace any internal or external components of the IBX-660 industrial edge storage server other than those listed below. If any other components fail or need replacement, contact the IEI reseller or vendor you purchased the IBX-660 from or contact an IEI sales representative directly. To contact an IEI sales representative, please send an email to [sales@ieiworld.com](mailto:sales@ieiworld.com).

---

The industrial server components listed below can all be replaced if they fail:

- SO-DIMM module (see **Section 3.4**)
- Hard disk drive (see **Section 3.5**)

Appendix

**A**

# Regulatory Compliance

---

**DECLARATION OF CONFORMITY**

This equipment is in conformity with the following EU directives:

- EMC Directive 2004/108/EC
- Low-Voltage Directive 2006/95/EC
- RoHS II Directive 2011/65/EU

If the user modifies and/or install other devices in the equipment, the CE conformity declaration may no longer apply.

If this equipment has telecommunications functionality, it also complies with the requirements of the R&TTE Directive 1999/5/EC.

---

English

IEI Integration Corp declares that this equipment is in compliance with the essential requirements and other relevant provisions of Directive 1999/5/EC.

---

Български [Bulgarian]

IEI Integration Corp. декларира, че този оборудване е в съответствие със съществените изисквания и другите приложими правила на Директива 1999/5/EC.

---

Česky [Czech]

IEI Integration Corp tímto prohlašuje, že tento zařizení je ve shodě se základními požadavky a dalšími příslušnými ustanoveními směrnice 1999/5/ES.

---

Dansk [Danish]

IEI Integration Corp erklærer herved, at følgende udstyr overholder de væsentlige krav og øvrige relevante krav i direktiv 1999/5/EF.

---

Deutsch [German]

IEI Integration Corp, erklärt dieses Gerät entspricht den grundlegenden Anforderungen und den weiteren entsprechenden Vorgaben der Richtlinie 1999/5/EU.

---

Eesti [Estonian]

IEI Integration Corp deklareerib seadme seadme vastavust direktiivi 1999/5/EÜ põhinõuetele ja nimetatud direktiivist tulenevatele teistele asjakohastele sätetele.

---

---

**Español [Spanish]**

IEI Integration Corp declara que el equipo cumple con los requisitos esenciales y cualesquiera otras disposiciones aplicables o exigibles de la Directiva 1999/5/CE.

---

**Ελληνική [Greek]**

IEI Integration Corp ΔΗΛΩΝΕΙ ΟΤΙ ΕΞΟΠΛΙΣΜΟΣ ΣΥΜΜΟΡΦΩΝΕΤΑΙ ΠΡΟΣ ΤΙΣ ΟΥΣΙΩΔΕΙΣ ΑΠΑΙΤΗΣΕΙΣ ΚΑΙ ΤΙΣ ΛΟΙΠΕΣ ΣΧΕΤΙΚΕΣ ΔΙΑΤΑΞΕΙΣ ΤΗΣ ΟΔΗΓΙΑΣ 1999/5/EK.

---

**Français [French]**

IEI Integration Corp déclare que l'appareil est conforme aux exigences essentielles et aux autres dispositions pertinentes de la directive 1999/5/CE.

---

**Italiano [Italian]**

IEI Integration Corp dichiara che questo apparecchio è conforme ai requisiti essenziali ed alle altre disposizioni pertinenti stabilite dalla direttiva 1999/5/CE.

---

**Latviski [Latvian]**

IEI Integration Corp deklarē, ka iekārta atbilst būtiskajām prasībām un citiem ar to saistītajiem noteikumiem Direktīvas 1999/5/EK.

---

**Lietuvių [Lithuanian]**

IEI Integration Corp deklaruoja, kad šis įranga atitinka esminius reikalavimus ir kitas 1999/5/EB Direktyvos nuostatas.

---

**Nederlands [Dutch]**

IEI Integration Corp dat het toestel toestel in overeenstemming is met de essentiële eisen en de andere relevante bepalingen van richtlijn 1999/5/EG.

---

**Malti [Maltese]**

IEI Integration Corp jiddikjara li dan prodott jikkonforma mal-ħtiġijiet essenzjali u ma provvedimenti oħrajn relevanti li hemm fid-Dirrettiva 1999/5/EC.

---

**Magyar [Hungarian]**

IEI Integration Corp nyilatkozom, hogy a berendezés megfelel a vonatkozó alapvető követelményeknek és az 1999/5/EC irányelv egyéb előírásainak.

---

**Polski [Polish]**

IEI Integration Corp oświadcza, że wyrobu jest zgodny z zasadniczymi wymogami oraz pozostałymi stosownymi postanowieniami Dyrektywy 1999/5/EC.

---

**Português [Portuguese]**

IEI Integration Corp declara que este equipamento está conforme com os requisitos essenciais e outras disposições da Directiva 1999/5/CE.

---

## IBX-660 Industrial Edge Storage Server

---

### Româna [Romanian]

IEI Integration Corp declară că acest echipament este în conformitate cu cerințele esențiale și cu celelalte prevederi relevante ale Directivei 1999/5/CE.

---

### Slovensko [Slovenian]

IEI Integration Corp izjavlja, da je ta opreme v skladu z bistvenimi zahtevami in ostalimi relevantnimi določili direktive 1999/5/ES.

---

### Slovensky [Slovak]

IEI Integration Corp týmto vyhlasuje, že zariadenia spĺňa základné požiadavky a všetky príslušné ustanovenia Smernice 1999/5/ES.

---

### Suomi [Finnish]

IEI Integration Corp vakuuttaa täten □ttä laitteet□on direktiivin 1999/5/EY oleellisten vaatimusten ja sitä koskevien direktiivin muiden ehtojen mukainen.

---

### Svenska [Swedish]

IEI Integration Corp förklarar att denna utrustningstyp står i överensstämmelse med de väsentliga egenskapskrav och övriga relevanta bestämmelser som framgår av direktiv 1999/5/EG.

---

**FCC WARNING**

This equipment complies with Part 15 of the FCC Rules. Operation is subject to the following two conditions:

- This device may not cause harmful interference, and
- This device must accept any interference received, including interference that may cause undesired operation.

This equipment has been tested and found to comply with the limits for a Class A digital device, pursuant to part 15 of the FCC Rules. These limits are designed to provide reasonable protection against harmful interference when the equipment is operated in a commercial environment. This equipment generates, uses, and can radiate radio frequency energy and, if not installed and used in accordance with the instruction manual, may cause harmful interference to radio communications. Operation of this equipment in a residential area is likely to cause harmful interference in which case the user will be required to correct the interference at his own expense.

**Federal Communication Commission Interference Statement**

This equipment has been assembled with components that comply with the limits for a Class B digital device, pursuant to Part 15 of the FCC Rules. These limits are designed to provide reasonable protection against harmful interference in a residential installation. This equipment generates, uses and can radiate radio frequency energy and, if not installed and used in accordance with the instructions, may cause harmful interference to radio communications. However, there is no guarantee that interference will not occur in a particular installation. If this equipment does cause harmful interference to radio or television reception, which can be determined by turning the equipment off and on, the user is encouraged to try to correct the interference by one of the following measures:

- Reorient or relocate the receiving antenna.
- Increase the separation between the equipment and receiver.
- Connect the equipment into an outlet on a circuit different from that to which the receiver is connected.
- Consult the dealer or an experienced radio/TV technician for help.

Appendix

**B**

# Safety Precautions

---

**WARNING:**

The precautions outlined in this chapter should be strictly followed. Failure to follow these precautions may result in permanent damage to the IBX-660.

## B.1 Safety Precautions

Please follow the safety precautions outlined in the sections that follow:

### B.1.1 General Safety Precautions

Please ensure the following safety precautions are adhered to at all times.

- ***Follow the electrostatic precautions*** outlined below whenever the IBX-660 is opened.
- ***Make sure the power is turned off and the power cord is disconnected*** whenever the IBX-660 is being installed, moved or modified.
- ***Do not apply voltage levels that exceed the specified voltage range.*** Doing so may cause fire and/or an electrical shock.
- ***Electric shocks can occur*** if the IBX-660 chassis is opened when the IBX-660 is running.
- ***If considerable amounts of dust, water, or fluids enter the IBX-660,*** turn off the power supply immediately, unplug the power cord, and contact the IBX-660 vendor.
- **DO NOT:**
  - Drop the IBX-660 against a hard surface.
  - In a site where the ambient temperature exceeds the rated temperature



## IBX-660 Industrial Edge Storage Server

### B.1.2 Anti-static Precautions

---



#### **WARNING:**

Failure to take ESD precautions during the installation of the IBX-660 may result in permanent damage to the IBX-660 and severe injury to the user.

---

Electrostatic discharge (ESD) can cause serious damage to electronic components, including the IBX-660. Dry climates are especially susceptible to ESD. It is therefore critical that whenever the IBX-660 is opened and any of the electrical components are handled, the following anti-static precautions are strictly adhered to.

- ***Wear an anti-static wristband:*** Wearing a simple anti-static wristband can help to prevent ESD from damaging any electrical component.
- ***Self-grounding:*** Before handling any electrical component, touch any grounded conducting material. During the time the electrical component is handled, frequently touch any conducting materials that are connected to the ground.
- ***Use an anti-static pad:*** When configuring or working with an electrical component, place it on an anti-static pad. This reduces the possibility of ESD damage.
- ***Only handle the edges of the electrical component:*** When handling the electrical component, hold the electrical component by its edges.

### B.1.3 Product Disposal

---

**CAUTION:**

Risk of explosion if battery is replaced by and incorrect type. Only certified engineers should replace the on-board battery.

Dispose of used batteries according to instructions and local regulations.

---

- Outside the European Union - If you wish to dispose of used electrical and electronic products outside the European Union, please contact your local authority so as to comply with the correct disposal method.
- Within the European Union:

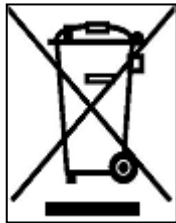

EU-wide legislation, as implemented in each Member State, requires that waste electrical and electronic products carrying the mark (left) must be disposed of separately from normal household waste. This includes monitors and electrical accessories, such as signal cables or power cords. When you need to dispose of your display products, please follow the guidance of your local authority, or ask the shop where you purchased the product. The mark on electrical and electronic products only applies to the current European Union Member States.

Please follow the national guidelines for electrical and electronic product disposal.

## B.2 Maintenance and Cleaning Precautions

When maintaining or cleaning the IBX-660, please follow the guidelines below.

### B.2.1 Maintenance and Cleaning

Prior to cleaning any part or component of the IBX-660, please read the details below.

- The interior of the IBX-660 does not require cleaning. Keep fluids away from the IBX-660 interior.

## IBX-660 Industrial Edge Storage Server

- Be cautious of all small removable components when vacuuming the IBX-660.
- Turn the IBX-660 off before cleaning the IBX-660.
- Never drop any objects or liquids through the openings of the IBX-660.
- Be cautious of any possible allergic reactions to solvents or chemicals used when cleaning the IBX-660.
- Avoid eating, drinking and smoking within vicinity of the IBX-660.

### B.2.2 Cleaning Tools

Some components in the IBX-660 may only be cleaned using a product specifically designed for the purpose. In such case, the product will be explicitly mentioned in the cleaning tips. Below is a list of items to use when cleaning the IBX-660.

- **Cloth** – Although paper towels or tissues can be used, a soft, clean piece of cloth is recommended when cleaning the IBX-660.
- **Water or rubbing alcohol** – A cloth moistened with water or rubbing alcohol can be used to clean the IBX-660.
- **Using solvents** – The use of solvents is not recommended when cleaning the IBX-660 as they may damage the plastic parts.
- **Vacuum cleaner** – Using a vacuum specifically designed for computers is one of the best methods of cleaning the IBX-660. Dust and dirt can restrict the airflow in the IBX-660 and cause its circuitry to corrode.
- **Cotton swabs** - Cotton swaps moistened with rubbing alcohol or water are excellent tools for wiping hard to reach areas.
- **Foam swabs** - Whenever possible, it is best to use lint free swabs such as foam swabs for cleaning.

Appendix

C

# Hazardous Materials Disclosure

---

## IBX-660 Industrial Edge Storage Server

The details provided in this appendix are to ensure that the product is compliant with the Peoples Republic of China (China) RoHS standards. The table below acknowledges the presences of small quantities of certain materials in the product, and is applicable to China RoHS only.

A label will be placed on each product to indicate the estimated “Environmentally Friendly Use Period” (EFUP). This is an estimate of the number of years that these substances would “not leak out or undergo abrupt change.” This product may contain replaceable sub-assemblies/components which have a shorter EFUP such as batteries and lamps. These components will be separately marked.

Please refer to the following table.

Part Name	Toxic or Hazardous Substances and Elements					
	Lead (Pb)	Mercury (Hg)	Cadmium (Cd)	Hexavalent Chromium (CR(VI))	Polybrominated Biphenyls (PBB)	Polybrominated Diphenyl Ethers (PBDE)
Housing	O	O	O	O	O	O
Display	O	O	O	O	O	O
Printed Circuit Board	O	O	O	O	O	O
Metal Fasteners	O	O	O	O	O	O
Cable Assembly	O	O	O	O	O	O
Fan Assembly	O	O	O	O	O	O
Power Supply Assemblies	O	O	O	O	O	O
Battery	O	O	O	O	O	O

O: This toxic or hazardous substance is contained in all of the homogeneous materials for the part is below the limit requirement in SJ/T11363-2006 (now replaced by GB/T 26572-2011).

X: This toxic or hazardous substance is contained in at least one of the homogeneous materials for this part is above the limit requirement in SJ/T11363-2006 (now replaced by GB/T 26572-2011).

此附件旨在确保本产品符合中国 RoHS 标准。以下表格标示此产品中某有毒物质的含量符合中国 RoHS 标准规定的限量要求。

本产品上会附有“环境友好使用期限”的标签，此期限是估算这些物质“不会有泄漏或突变”的年限。本产品可能包含有较短的环境友好使用期限的可替换元件，像是电池或灯管，这些元件将会单独标示出来。

部件名称	有毒有害物质或元素					
	铅 (Pb)	汞 (Hg)	镉 (Cd)	六价铬 (CR(VI))	多溴联苯 (PBB)	多溴二苯 醚 (PBDE)
壳体	○	○	○	○	○	○
显示	○	○	○	○	○	○
印刷电路板	○	○	○	○	○	○
金属螺帽	○	○	○	○	○	○
电缆组装	○	○	○	○	○	○
风扇组装	○	○	○	○	○	○
电力供应组装	○	○	○	○	○	○
电池	○	○	○	○	○	○

○: 表示该有毒有害物质在该部件所有物质材料中的含量均在 SJ/T 11363-2006 (现由 GB/T 26572-2011 取代) 标准规定的限量要求以下。

X: 表示该有毒有害物质至少在该部件的某一均质材料中的含量超出 SJ/T 11363-2006 (现由 GB/T 26572-2011 取代) 标准规定的限量要求。