

PPC-F Bay Trail Fanless Series

5.7"/8"/10.4" Fanless Intel® Bay Trail Solution

Features

- 5.7", 8" and 10.4" fanless industrial panel PC
- 2.0 GHz Intel® Celeron® J1900 quad-core processor or 1.58 GHz Intel® Celeron® N2807 dual-core processor
- Low power consumption DDR3L memory supported
- IP 65 compliant front panel
- 9 V~30 V wide DC input
- mSATA SSD supported
- Dual GbE for backup
- -10°C~50°C extended operating temperature



Specifications

Model		PPC-F06B-BT	PPC-F08B-BT	PPC-F10B-BT
LCD	LCD Display	5.7" (4:3)	8" (4:3)	10.4"
	Max. Resolution	640 (W) x 480 (H)	800 (W) x 600 (H)	800 (W) x 600 (H)
	Brightness (cd/m²)	550	500	400
	Contrast Ratio	800:1	500:1	700:1
	LCD Color	262K	16.2M	16.2M
	Pixel Pitch (mm)	0.18 (H) x 0.18 (V)	0.2025 (H) x 0.0675 (V)	0.264 (H) x 0.264 (V)
	Viewing Angle (H-V)	160° / 140°	140° / 120°	160° / 140°
	Backlight MTBF (hrs)	50000	50000	30000
Motherboard	CPU	Intel® Celeron® N2807 dual-core processor, 1.58GHz	Intel® Celeron® J1900 quad-core on-board SoC, 2GHz	
	RAM	2GB DDR3L 1600MHz on-board RAM (system max. 4GB, by MOQ=300pcs)	1 x 204-pin DDR3L SO-DIMM slots (max. 8GB)	
Touch	Touchscreen & Controller	4-wire resistive type flat touch window, PenMount DMC9000	5-wire resistive type flat touchscreen, PenMount DMC9000	
	Surface Hardness	3H	3H	3H
Input Interfaces	I/O Ports & Switches	2 x RJ-45 LAN port 1 x RS-232 COM port (DB-9 connector) (RI/5V/12V) 1 x RS-422/485 2 x USB 3.0 2 x USB 2.0 1 x 9 V~30 V DC lockable DC jack (2-pin) 1 x Audio port (line-out) 1 x Power switch 1 x Reset button 1 x AT/ATX switch	1 x RS-232 COM port (RJ-45 connector) 1 x RS-232/422/485 COM port (DB-9 connector) (RI/5V/12V) 2 x USB 3.0 2 x GbE LAN 1 x Power switch 1 x Reset button 1 x AT/ATX switch 1 x Audio port (line-out) 1 x 9 V~30 V lockable power jack	1 x RS-232 COM port (RJ-45 connector) 1 x RS-232/422/485 COM port (DB9 connector) (RI/5V/12V) 2 x USB 2.0 2 x USB 3.0 2 x GbE LAN 1 x Power switch 1 x Reset button 1 x AT/ATX switch 1 x Audio port (line-out) 1 x 9 V~30 V lockable power jack
	Expansion	1 x Full-size PCIe Mini slot (mSATA/PCIe/USB signal)	1 x Full-size PCIe Mini slot (mSATA/PCIe/USB signal) 1 x Full-size/half-size PCIe Mini slot (PCIe/USB signal)	
Wireless LAN		802.11 b/g/n (optional)		
Storage	SSD	mSATA	mSATA	mSATA
	HDD	N/A	N/A	1 x 2.5" HDD bay
Physical	Construction Material		Aluminum front bezel	
	Mounting	Stand, panel mount, rack mount, VESA 75x75	Stand, panel mount, rack mount, VESA 75x75	Stand, panel mount, rack mount, VESA 75x75/100x100
	Enclosure Color		Black C	
	Dimensions (mm)	136.4 x 178.5 x 56.3	182.2 x 222.2 x 44	232.4 x 285.2 x 44
	Net Weight	0.89 kg	1.17 kg	1.77 kg
	Cut-out Dimensions (mm)	157.5 x 115.4	207 x 154	267.2 x 214.4
Environment	Operating Temperature (with air flow)	-10°C~50°C (14°F~122°F)		
	Storage Temperature	-20°C~60°C (-4°F~140°F)		
	Humidity	10% to 95% (non-condensing)		
	IP Level	IP 65 compliant front panel		
	Safety and EMC	CE & FCC Class A certified		
Power	Power Adapter	P/N: 63040-010036-121-RS 36W Power Adapter Input: 90 - 264V AC, 50/60Hz Output: 12V DC		
	Power Requirement	9 - 30V DC		
	Power Consumption	24W	28W	34W

Ordering Information

Part Number	Description
PPC-F06B-BT-N1/2G/R-R10	5.7" 450 cd/m ² VGA panel PC with Intel® Celeron® processor N2807, TDP 4.3W, 2GB on-board DDR3L RAM, black color, 9-30V DC input, resistive touch window, R10
PPC-F08B-BT-J1/2G/R-R10	8" 500 cd/m ² SVGA panel PC with Intel® Celeron® processor J1900, TDP 10W, 2GB DDR3L RAM, black color, 9-30V DC input, resistive touch window, R10
PPC-F10B-BT-J1/2G/R-R10	10.4" 400 cd/m ² SVGA panel PC with Intel® Celeron® processor J1900, TDP 10W, 2GB DDR3L RAM, black color, 9-30V DC input, resistive touch window, R10

Options

Item	PPC-F06B	PPC-F08B	PPC-F10B
Arm	ARM-11-RS	ARM-11-RS	ARM-11-RS
Stand	STAND-100-RS STAND-B08	STAND-100-RS STAND-B08 STAND-C12-R10	STAND-100-RS STAND-B08 STAND-C12-R10
Wall Mount Kit	AFLWK-12	AFLWK-12	AFLWK-12
Panel Mount Kit	FPK-07-R10	FPK-07-R10	FPK-09-R10
Wi-Fi Kit	EMB-WIFI-KIT01-R20		

Packing List

Item	Q'ty	Remark
PPC-FxxB-BTi Panel PC	1	
User Manual & Driver CD	1	
One Key Recovery CD	1	
Touch Pen	1	Resistive type models only P/N: 43125-0002C0-00-RS
Power Cord	1	Part numbers vary by regions
Screw Pack	1	Including necessary screws
Power Adapter	1	9V~30V DC P/N: 63040-010036-121-RS

PPC-F06B Fully Integrated I/O

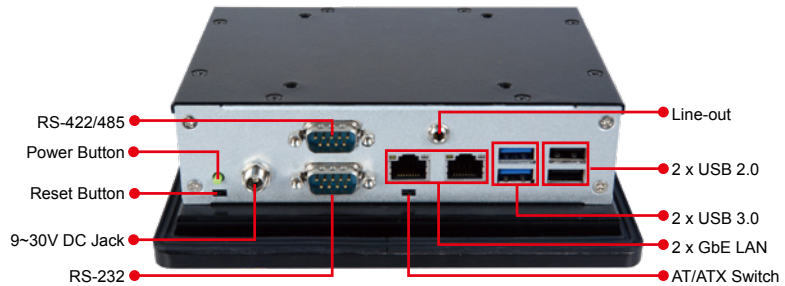

PPC-F08B Fully Integrated I/O

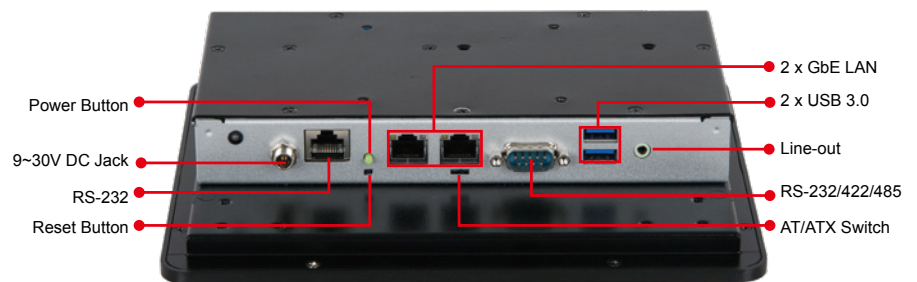

PPC-F10B Fully Integrated I/O

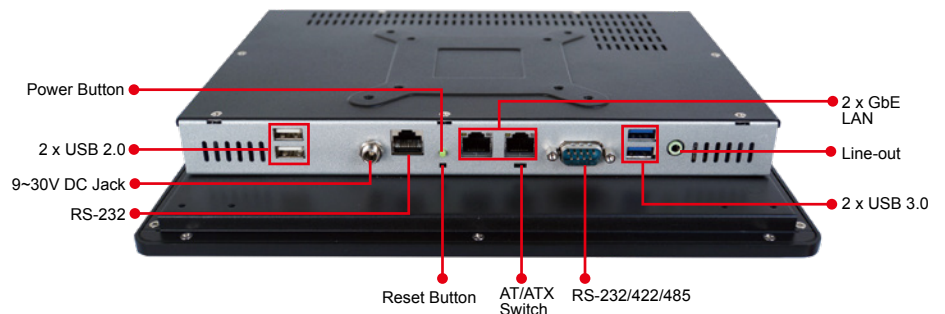

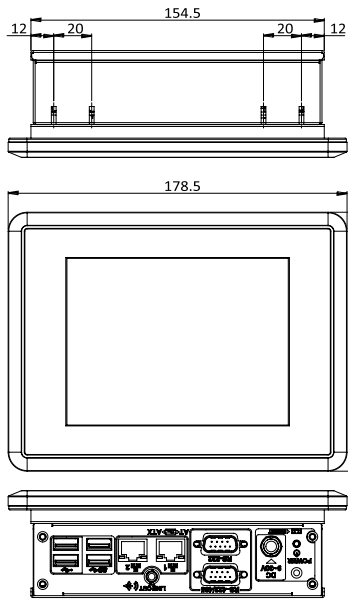

PPC-F06B-BT
Dimensions (Unit: mm)

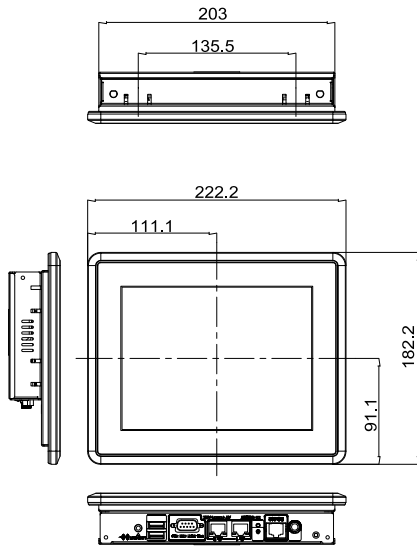
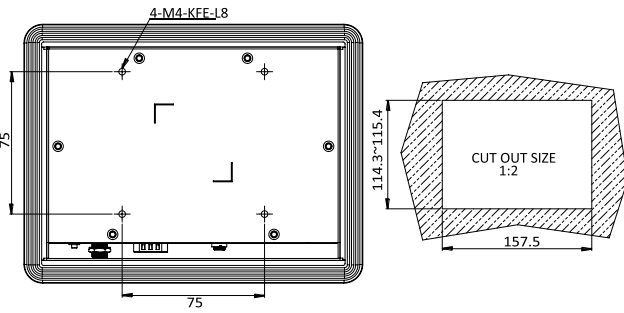

PPC-F08B-BT
Dimensions (Unit: mm)

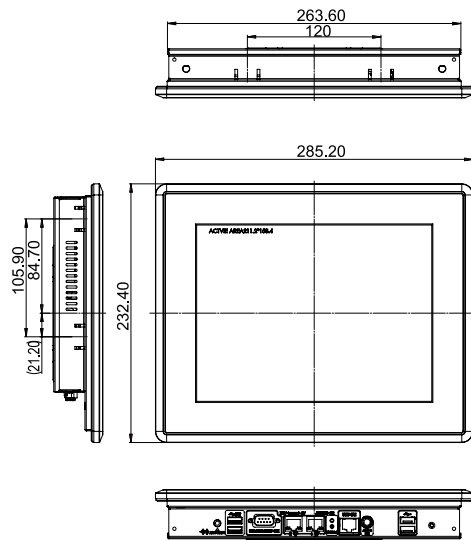
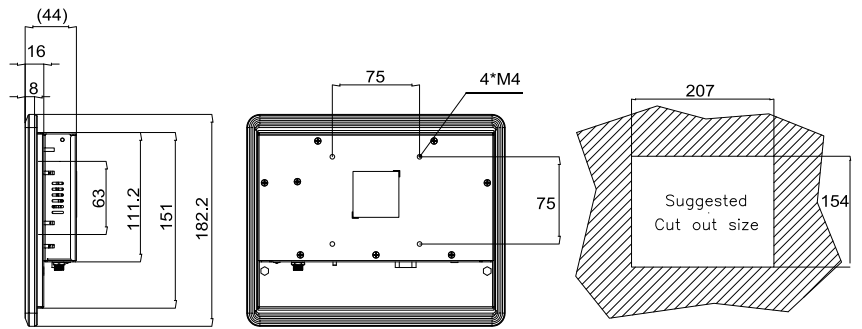

PPC-F10B-BT
Dimensions (Unit: mm)

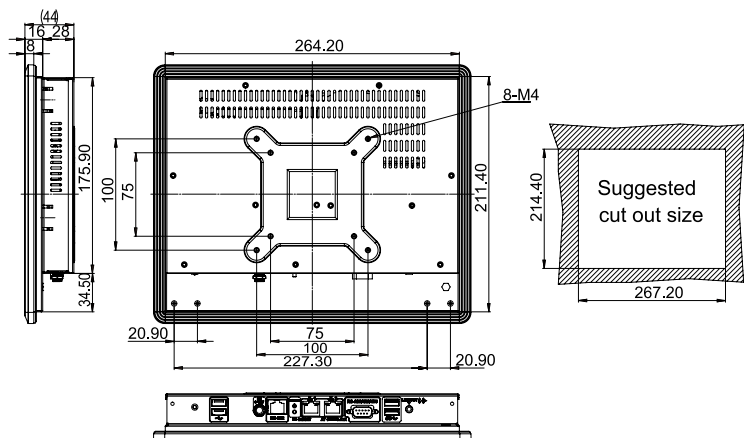

PPC-F Bay Trail Fanless Series

12"/15"/17"/19" Fanless Intel® Bay Trail Solution

Features

- Support IEI iRIS-2400 remote intelligent solution
- Intel® Celeron® J1900 quad-core SoC
- Robust IP65 aluminum front bezel
- Aesthetic ultra-thin bezel for seamless panel mount installation
- Projected capacitive multi-touch and resistive single touch options
- Dual full-size PCIe Mini card expansion
- 9V~36V DC wide range DC input



Specifications

New

Model		PPC-F12B-BT	PPC-F15B-BT	PPC-F17B-BT	PPC-F19B-BT
LCD	LCD Display	12.1" (4:3)	15" (4:3)	17" (5:4)	19" (5:4)
	Max. Resolution	1024 (W) x 768 (H)	1024 (W) x 768 (H)	1280 (W) x 1024 (H)	1280 (W) x 1024 (H)
	Brightness (cd/m ²)	600	450	350	350
	Contrast Ratio	700 : 1	800 : 1	800 : 1	1000 : 1
	LCD Color	16.2M	16.2M	16.7M	16.7M
	Pixel Pitch (mm)	0.24 x 0.24	0.297 x 0.297	0.26 x 0.26	0.294 x 0.294
	Viewing Angle (H-V)	160° / 140°	160° / 150°	170° / 160°	170° / 160°
Backlight MTBF (hrs)	50000	70000	50000	50000	
Motherboard	CPU	Intel® Celeron® processor J1900 (2M cache, up to 2.42 GHz)			
	RAM	2 x 204-pin DDR3L SO-DIMM slot (max. 8GB), pre-installed with 2GB			
Touch	Touchscreen & Controller	5-wire resistive type single touch window (Penmount 9000), 3H 2-point projected capacitive touch window (EETI EXC7200), 6H			
Input Interfaces	I/O Ports & Switches	2 x RJ-45 LAN port 2 x USB 3.0 2 x USB 2.0 1 x HDMI 2 x RS-232 1 x RS-232/422/485 1 x VGA 1 x 9 V~36 V DC jack (4-pin) 1 x 9 V~36 V DC terminal block 1 x Line-out (PPC-F15B & PPC-F17B & PPC-F19B only) 1 x Power switch			
	Expansion	1 x Full-size PCIe Mini slot (mSATA/PCIe/USB signal) 1 x Full-size/half-size PCIe Mini slot (PCIe/USB signal)			
Wireless LAN		802.11 b/g/n (optional)			
Drive Bay		1 x 2.5" HDD/SSD drive bay			
Remote Management Solution		iRIS-2400, QTS-Gateway			
Physical	Construction Material	Aluminum front panel and sheet metal rear cover			
	Mounting	Panel mount, rack mount, VESA 100x100			
	Enclosure Color	Black C			
	Dimensions (mm) (W x L x D)	262.2 x 322.2 x 47.2	303 x 378.5 x 46.2	341.4 x 408.4 x 51.8	372.4 x 447.4 x 52.87
	Weight (Net)	3.2 kg	4.1 kg	5 kg	6.5 kg
	Cutout Dimensions (mm)	244.8 x 304.8	285.6 x 361	323 x 390	355 x 430
Environment	Operating Temperature (with air flow)	-10°C~50°C (14°F~122°F)			
	Storage Temperature	-20°C~60°C (-4°F~140°F)			
	Humidity	10% to 95% (non-condensing)			
	IP Level	IP 65 compliant front panel			
	Safety and EMC	CE & FCC Class A certified			
Power	Power Adapter	P/N: 63040-010060-110-RS 60W Power Adapter Input: 90 - 264V AC, 50/60Hz Output: 12V DC			
	Power Requirement	9 V~36 V DC			
	Power Consumption	40W	41W	42W	33W

Ordering Information

Part Number	Description
PPC-F12B-BTi-J1/2G/R-R10	12" 600 cd/m ² XGA panel PC with Intel® Celeron® processor J1900, TDP 10W, one 2 GB RAM, supports iRIS-2400, black color, 9-36V DC input, resistive touch window, R10
PPC-F12B-BTi-J1/2G/PC-R11	12" 600 cd/m ² XGA panel PC with Intel® Celeron® processor J1900, TDP 10W, one 2 GB RAM, supports iRIS-2400, black color, 9-36V DC input, projected capacitive touch window, R11
PPC-F15B-BTi-J1/2G/R-R20	15" 450 cd/m ² XGA panel PC with Intel® Celeron® processor J1900, TDP 10W, one 2 GB RAM, supports iRIS-2400, black color, 9-36V DC input, resistive touch window, R20
PPC-F15B-BTi-J1/2G/PC-R21	15" 450 cd/m ² XGA panel PC with Intel® Celeron® processor J1900, TDP 10W, one 2 GB RAM, supports iRIS-2400, black color, 9-36V DC input, projected capacitive touch window, R21
PPC-F17B-BTi-J1/2G/R-R10	17" 350 cd/m ² SXGA panel PC with Intel® Celeron® processor J1900, TDP 10W, one 2 GB RAM, supports iRIS-2400, black color, 9-36V DC input, resistive touch window, R10
PPC-F17B-BTi-J1/2G/PC-R11	17" 350 cd/m ² SXGA panel PC with Intel® Celeron® processor J1900, TDP 10W, one 2 GB RAM, supports iRIS-2400, black color, 9-36V DC input, projected capacitive touch window, R11
PPC-F19B-BTi-J1/2G/R-R11	19" 350 cd/m ² SXGA panel PC with Intel® Celeron® Processor J1900, TDP 10W, one 2GB RAM, support iRIS-2400, black color, 9-36V DC input, resistive touch window, R11
PPC-F19B-BTi-J1/2G/PC-R11	19" 350 cd/m ² SXGA panel PC with Intel® Celeron® Processor J1900, TDP 10W, one 2GB RAM, support iRIS-2400, black color, 9-36V DC input, projected capacitive touch window, R11



QTS-Gateway

Part Number	Description
PPC-F12B-BT-QGW-J1/4G/PC-R11	12" 600 cd/m ² XGA Panel PC with IntelR CeleronR Processor J1900, TDP 10W, 2GB RAM*2, black color, with QTS-Gateway, 9-36V DC input, projected capacitive touch window, R11
PPC-F15B-BT-QGW-J1/4G/PC-R11	15" 450 cd/m ² XGA Panel PC with IntelR CeleronR Processor J1900, TDP 10W, 2GB RAM*2, black color, with QTS-Gateway, 9-36V DC input, projected capacitive touch window, R11
PPC-F17B-BT-QGW-J1/4G/PC-R11	17" 350 cd/m ² SXGA Panel PC with IntelR CeleronR Processor J1900, TDP 10W, 2GB RAM*2, black color, with QTS-Gateway, 9-36V DC input, projected capacitive touch window, R11
PPC-F19B-BT-QGW-J1/4G/PC-R11	19" 350 cd/m ² SXGA Panel PC with IntelR CeleronR Processor J1900, TDP 10W, 2GB RAM*2, black color, with QTS-Gateway, 9-36V DC input, projected capacitive touch window, R11

Packing List

Item	Q'ty	Remark
PPC-FxxB-BTi Panel PC	1	
User Manual & Driver CD	1	
One Key Recovery CD	1	
Touch Pen	1	Resistive type models only P/N: 43125-0002C0-00-RS
Power Cord	1	Part numbers vary by regions
Screw Pack	1	Including necessary screws
Power Adapter	1	9V~36V DC P/N: 63040-010060-110-RS

Options

Item	PPC-F12B	PPC-F15B	PPC-F17B	PPC-F19B
Arm	ARM-31-RS			
Stand	STAND-C12-R10 STAND-A12-RS	STAND-C19-R10 STAND-A19-RS	STAND-C19-R10 STAND-A19-RS	STAND-C19-R10 STAND-A19-RS
Wall Mount Kit	WK-190MS-R10			
Panel Mount Kit	FPK-09-R10	FPK-10-R10	FPK-10-R10	FPK-11-R10
Rack Mount Kit	FRK12-R10	FRK15-R10	FRK17-R10	FRK-19P-R10
Wi-Fi Kit	EMB-WIFI-KIT01-R20	EMB-WIFI-KIT11-R20	EMB-WIFI-KIT11-R20	EMB-WIFI-KIT11-R20
iRIS (IEI Remote Intelligent System) Kit	iRIS-2400-RS			

PPC-F12B Fully Integrated I/O

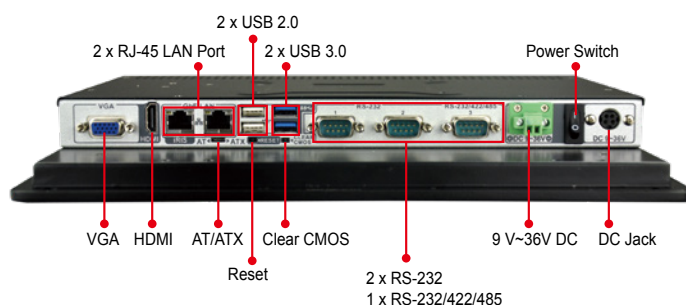

PPC-F15B
Fully Integrated I/O

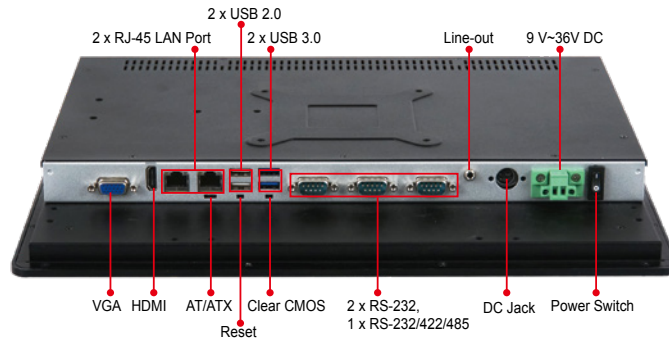

PPC-F17B
Fully Integrated I/O

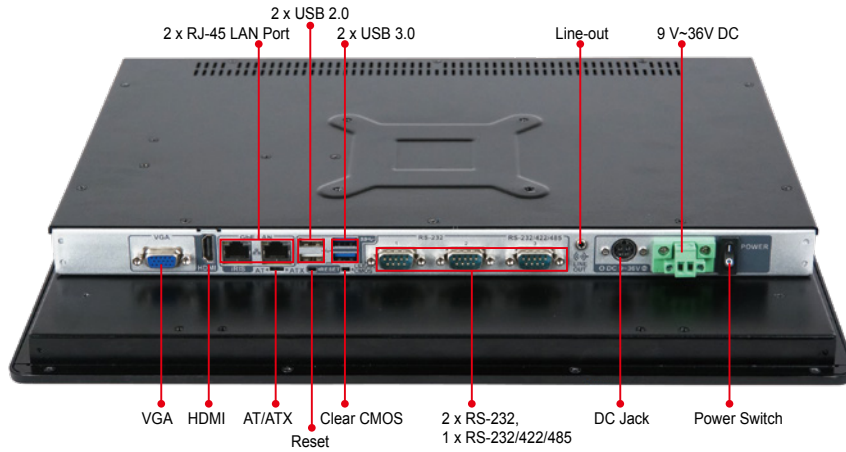

PPC-F19B
Fully Integrated I/O

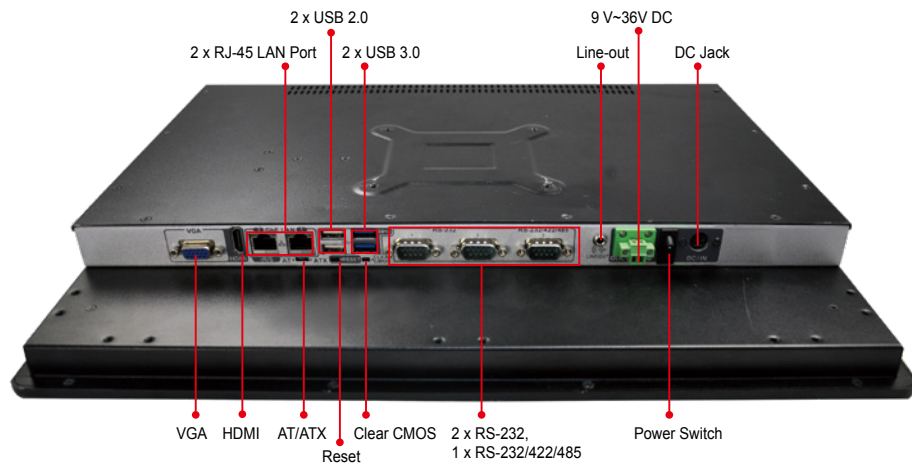

PPC-F12B
Dimensions (Unit: mm)

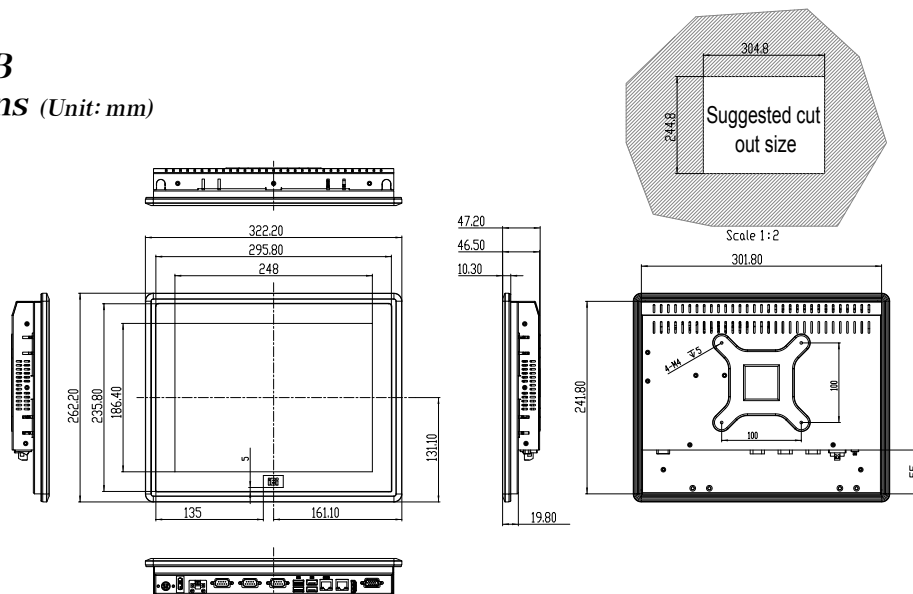

PPC-F15B
Dimensions (Unit: mm)

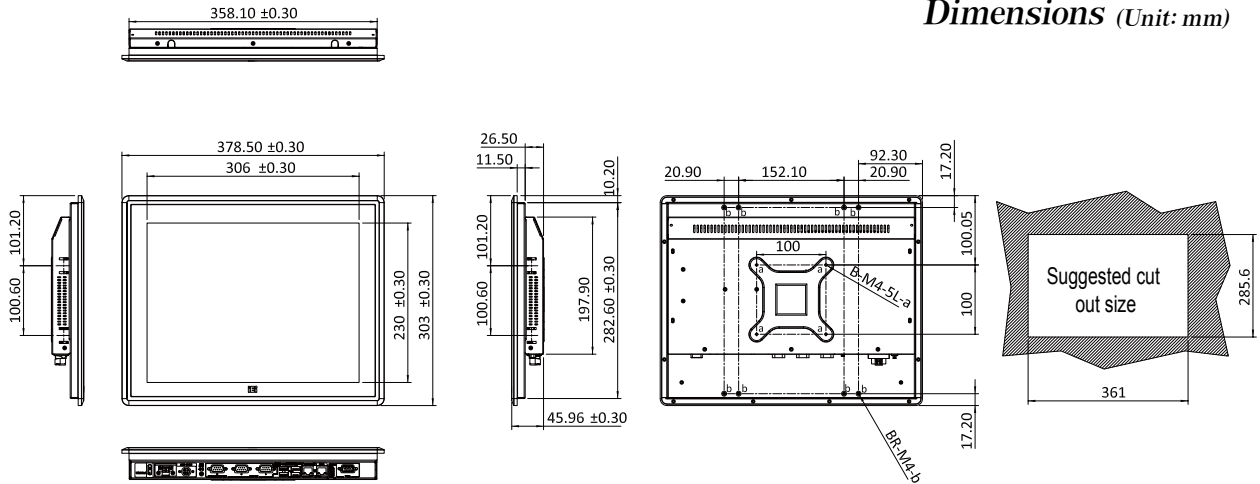

PPC-F17B
Dimensions (Unit: mm)

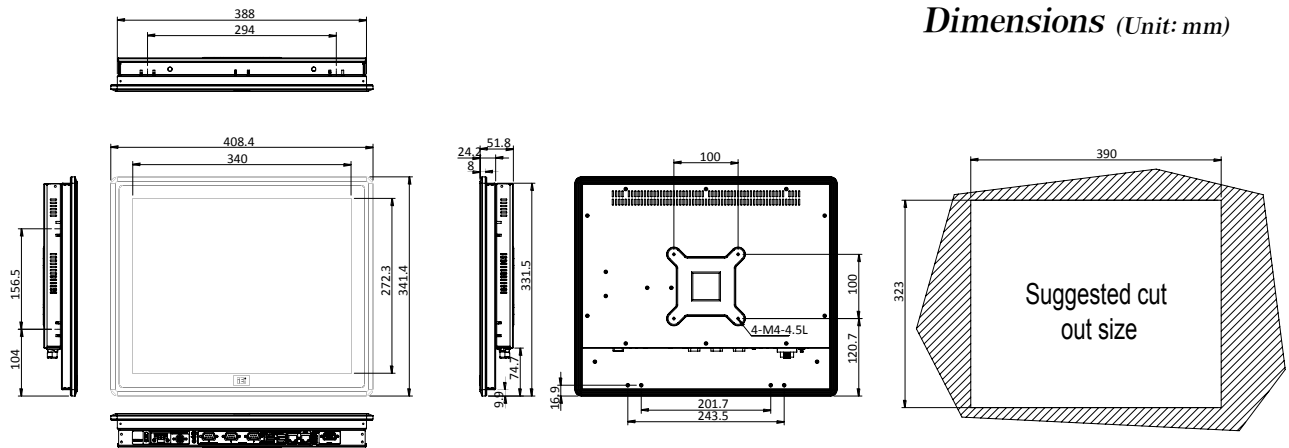

PPC-F19B
Dimensions (Unit: mm)

