



MODEL:

TANK-870-Q170 Series

Embedded System with 6th Generation Intel® Core™ processor,
4GB DDR4 pre-installed memory, VGA/HDMI+DP/iDP,
Two Gigabit Ethernet, RS-232/422/485,
RoHS Compliant

User Manual

Revision

Date	Version	Changes
6 March 2017	1.01	Add iDP module installation in Section 4.2.5: DisplayPort Connector (DP1)
19 December 2016	1.00	Initial release

Copyright

COPYRIGHT NOTICE

The information in this document is subject to change without prior notice in order to improve reliability, design and function and does not represent a commitment on the part of the manufacturer.

In no event will the manufacturer be liable for direct, indirect, special, incidental, or consequential damages arising out of the use or inability to use the product or documentation, even if advised of the possibility of such damages.

This document contains proprietary information protected by copyright. All rights are reserved. No part of this manual may be reproduced by any mechanical, electronic, or other means in any form without prior written permission of the manufacturer.

TRADEMARKS

All registered trademarks and product names mentioned herein are used for identification purposes only and may be trademarks and/or registered trademarks of their respective owners.

Manual Conventions



WARNING

Warnings appear where overlooked details may cause damage to the equipment or result in personal injury. Warnings should be taken seriously.



CAUTION

Cautionary messages should be heeded to help reduce the chance of losing data or damaging the product.



NOTE

These messages inform the reader of essential but non-critical information. These messages should be read carefully as any directions or instructions contained therein can help avoid making mistakes.



HOT SURFACE

This symbol indicates a hot surface that should not be touched without taking care.

Table of Contents

1 INTRODUCTION	1
1.1 OVERVIEW.....	2
1.2 MODEL VARIATIONS.....	3
1.3 FEATURES.....	3
1.4 TECHNICAL SPECIFICATIONS.....	4
1.5 FRONT PANEL.....	7
1.5.1 TANK-870-Q170-2 slot Front Panel.....	7
1.5.2 TANK-870-Q170-4 slot Front Panel.....	9
1.6 REAR PANEL.....	10
1.7 LED INDICATORS.....	10
1.8 BACKPLANE OPTIONS.....	12
1.9 PHYSICAL DIMENSIONS.....	19
1.9.1 TANK-870-Q170-2 slot Physical Dimensions.....	19
1.9.2 TANK-870-Q170-4 slot Physical Dimensions.....	20
2 UNPACKING	21
2.1 ANTI-STATIC PRECAUTIONS.....	22
2.2 UNPACKING PRECAUTIONS.....	22
2.3 UNPACKING CHECKLIST.....	23
3 INSTALLATION	27
3.1 INSTALLATION PRECAUTIONS.....	28
3.2 HARD DISK DRIVE (HDD) INSTALLATION.....	28
3.3 SYSTEM FAN INSTALLATION.....	30
3.4 MOUNTING THE SYSTEM WITH MOUNTING BRACKETS.....	31
3.5 EXTERNAL PERIPHERAL INTERFACE CONNECTORS.....	32
3.5.1 ACC Mode Selection.....	33
3.5.2 AT/ATX Power Mode Selection.....	34
3.5.3 Audio Connector.....	34
3.5.4 Digital Input/Output Connector.....	35

3.5.5 LAN Connectors.....	35
3.5.6 Power Input, 3-pin Terminal Block.....	36
3.5.7 Power Input, 4-pin DIN Connector	37
3.5.8 RJ-45 RS-232 Serial Ports.....	37
3.5.9 DB-9 RS-232/422/485 Serial Port Connectors.....	38
3.5.10 USB Connectors.....	39
3.5.11 VGA Connector	40
3.6 INTERNAL PERIPHERAL INTERFACE CONNECTORS	41
3.6.1 iDP Module Installation.....	41
3.7 POWERING ON/OFF THE SYSTEM	45
3.8 POWER.....	45
3.8.1 ACC ON Mode	46
3.8.2 ACC OFF Mode.....	47
4 SYSTEM MOTHERBOARD.....	48
4.1 OVERVIEW.....	49
4.1.1 Layout	49
4.2 INTERNAL PERIPHERAL CONNECTORS.....	50
4.2.1 Backplane Power Connector (JP1)	50
4.2.2 Battery Connector (BAT1).....	51
4.2.3 BIOS Programming Connector (JSP11)	51
4.2.4 CPU Fan Connector (CPU_FAN1).....	51
4.2.5 DisplayPort Connector (DP1).....	51
4.2.6 EC Debug Connector (CN4).....	52
4.2.7 EC Programming Connector (JSP12).....	52
4.2.8 Keyboard and mouse connector (KB_MS1)	52
4.2.9 LED Connector (J2).....	53
4.2.10 SATA Power Connectors (CN2, CN3).....	53
4.2.11 TPM Connector (TPM1)	53
4.2.12 USB 3.0 connectors (USB3-1)	54
4.3 EXTERNAL INTERFACE PANEL CONNECTORS.....	54
4.3.1 Audio Jack (JAUDIO1).....	55
4.3.2 DIO connector (DIO1).....	55
4.3.3 Ethernet and USB3.0 Connectors (LAN1_USB1).....	55
4.3.4 Ethernet and USB3.0 Connectors (LAN2_USB2).....	56

TANK-870-Q170 Embedded System

4.3.5 Power Connector (PWR1)	57
4.3.6 Power Connector (PWR2)	57
4.3.7 RS-232 Serial Port Connector (COM1_2).....	57
4.3.8 RS-232 Serial Port Connectors (COM3_4).....	57
4.3.9 RS-232/422/485 Serial Port Connector (COM5_6)	58
4.3.10 USB 2.0 Connectors (USB1).....	58
4.3.11 USB 2.0 Connectors (USB2).....	58
4.3.12 VGA Connector (VGA1).....	58
5 BIOS	60
5.1 INTRODUCTION	61
5.1.1 Starting Setup.....	61
5.1.2 Using Setup	61
5.1.3 Getting Help.....	62
5.1.4 Unable to Reboot after Configuration Changes	62
5.1.5 BIOS Menu Bar.....	62
5.2 MAIN	64
5.3 ADVANCED.....	65
5.3.1 Trusted Computing.....	66
5.3.2 ACPI Settings	67
5.3.3 AMT Configuration.....	68
5.3.4 F81866 Super IO Configuration	69
5.3.4.1 Serial Port n Configuration	69
5.3.5 RTC Wake Settings	75
5.3.6 Serial Port Console Redirection	76
5.3.6.1 Console Redirection Settings	77
5.3.7 CPU Configuration.....	80
5.3.8 SATA Configuration	83
5.3.9 USB Configuration.....	84
5.3.10 iEi Feature.....	85
5.3.11 iWDD H/W Monitor	86
5.3.11.1 Smart Fan Mode Configuration	87
5.4 CHIPSET.....	88
5.4.1 System Agent (SA) Configuration	89
5.4.1.1 Graphics Configuration.....	90

5.4.1.2 PEG Port Configuration.....	92
5.4.1.3 Memory Configuration.....	93
5.4.2 PCH-IO Configuration	94
5.4.2.1 PCI Express Configuration.....	95
5.4.2.2 HD Audio Configuration.....	97
5.5 SECURITY.....	97
5.6 BOOT.....	99
5.7 SAVE & EXIT	101
5.8 SERVER MGMT	102
5.8.1.1 System Event Log	103
5.8.1.2 BMC network configuration	104
A REGULATORY COMPLIANCE.....	105
B BIOS OPTIONS	111
C TERMINOLOGY.....	115
D SAFETY PRECAUTIONS.....	119
D.1 SAFETY PRECAUTIONS	120
D.1.1 General Safety Precautions.....	120
D.1.2 Anti-static Precautions.....	121
D.1.3 Product Disposal.....	122
D.2 MAINTENANCE AND CLEANING PRECAUTIONS.....	122
D.2.1 Maintenance and Cleaning	123
D.2.2 Cleaning Tools.....	123
E DIGITAL I/O INTERFACE.....	125
E.1 INTRODUCTION.....	126
E.2 ASSEMBLY LANGUAGE SAMPLE 1	127
E.3 ASSEMBLY LANGUAGE SAMPLE 2	127
F HAZARDOUS MATERIALS DISCLOSURE.....	128

List of Figures

Figure 1-1: TANK-870-Q170 Series	2
Figure 1-2: TANK-870-Q170 Series Front Panel	7
Figure 1-3: TANK-870-Q170 Series Front Panel	9
Figure 1-4: TANK-870-Q170 Series Rear Panel	10
Figure 1-5: TANK-870-Q170 Series LED Indicators.....	11
Figure 1-6: HPE-2S86 (for 2A model).....	12
Figure 1-7: HPE-4AS87 (for 4A model).....	12
Figure 1-8: HPE-2S87 (for 2B model).....	14
Figure 1-9: HPE-4S87 (for 4B model).....	15
Figure 1-10: TANK-870-Q170-2 slot Physical Dimensions (millimeters).....	19
Figure 1-11: TANK-870-Q170-4 slot Physical Dimensions (millimeters).....	20
Figure 3-1: Unscrew the Cover.....	29
Figure 3-2: Remove the Cover from TANK-870-Q170 Series	29
Figure 3-3: HDD Installation	30
Figure 3-4: HDD Retention Screws	30
Figure 3-5: System Fan Installation	31
Figure 3-6: Mounting Bracket Retention Screws	32
Figure 3-7: ACC Mode Switch	33
Figure 3-8: AT/ATX Power Mode Switch	34
Figure 3-9: Audio Connector	34
Figure 3-10: DIO Connector.....	35
Figure 3-11: LAN Connection	35
Figure 3-12: RJ-45 Ethernet Connector.....	36
Figure 3-13: 3-pin Terminal Block.....	36
Figure 3-14: Power Input Connector.....	37
Figure 3-15: RJ-45 RS-232 Serial Device Connection.....	37
Figure 3-16: RJ-45 RS-232 Serial Port Connector	38
Figure 3-17: Serial Device Connector.....	38
Figure 3-18: DB-9 RS-232/422/485 Serial Port Connector	39
Figure 3-19: USB Device Connection	39

Figure 3-20: VGA Connector	40
Figure 3-21: VGA Connector	41
Figure 3-22: Internal DisplayPort Connector Location	41
Figure 3-23: iDP Module with Bracket	42
Figure 3-24: iDP Module Installation.....	42
Figure 3-25: Remove Expansion Slot Bracket.....	43
Figure 3-26: Secure iDP Module to System	43
Figure 3-27: Power Button.....	45
Figure 3-28: Power Connectors	46
Figure 4-1: System Motherboard (Front).....	49
Figure 4-2: System Motherboard (Rear).....	49

List of Tables

Table 1-1: TANK-870-Q170 Series Model Variations	3
Table 1-2: Technical Specifications	6
Table 1-3: LED Indicators Description	11
Table 1-4: Supported Signals	17
Table 1-5: Rated Voltage and Current	18
Table 3-1: RJ-45 Ethernet Connector LEDs	36
Table 3-2: iDP Converter Cards	44
Table 3-3: Power LED Indicators Description	46
Table 4-1: Peripheral Interface Connectors	50
Table 4-2: Backplane Power Connector Pinouts (JP1)	51
Table 4-3: Battery Connector Pinouts (BAT1)	51
Table 4-4: BIOS Programming Connector Pinouts (JSPI1)	51
Table 4-5: CPU Fan Connector Pinouts (CPU_FAN1)	51
Table 4-6: DisplayPort connector Pinouts (DP1)	52
Table 4-7: EC Debug Connector Pinouts (CN4)	52
Table 4-8: EC Programming Connector Pinouts (JSPI2)	52
Table 4-9: Keyboard and mouse connector Pinouts (KB_MS1)	52
Table 4-10: LED Connector Pinouts (J2)	53
Table 4-11: SATA Power Connectors Pinouts (CN2, CN3)	53
Table 4-12: TPM Connector Pinouts (TPM1)	53
Table 4-13: USB 3.0 connectors Pinouts (USB3-1)	54
Table 4-14: Rear Panel Connectors	54
Table 4-15: Audio Jack Pinouts (JAUDIO1)	55
Table 4-16: DIO connector Pinouts (DIO1)	55
Table 4-17: USB 3.0 Port Pinouts (USB1)	55
Table 4-18: LAN Pinouts (LAN1)	56
Table 4-19: USB 3.0 Port Pinouts (USB2)	56
Table 4-20: LAN Pinouts (LAN2)	56
Table 4-21: Power Connector Pinouts (PWR2)	57
Table 4-22: Power Connector Pinouts (PWR1)	57

Table 4-23: RS-232 Serial Port Connector Pinouts (COM1_2)	57
Table 4-24: RS-232 Serial Port Connectors Pinouts (COM3_4)	57
Table 4-25: RS-232/422/485 Serial Port Connector Pinout (COM5_6)	58
Table 4-26: USB 2.0 Connectors Pinouts (USB1)	58
Table 4-27: USB 2.0 Connectors Pinouts (USB2)	58
Table 4-28: VGA Connector Pinouts (VGA1)	59
Table 5-1: BIOS Navigation Keys	62

BIOS Menus

BIOS Menu 1: Main	64
BIOS Menu 2: Advanced	66
BIOS Menu 3: Trusted Computing	66
BIOS Menu 4: ACPI Configuration	67
BIOS Menu 5: AMT Configuration	68
BIOS Menu 6: F81866 Super IO Configuration	69
BIOS Menu 7: Serial Port n Configuration Menu	69
BIOS Menu 8: RTC Wake Settings	75
BIOS Menu 9: Serial Port Console Redirection	77
BIOS Menu 10: Console Redirection Settings	78
BIOS Menu 11: CPU Configuration	80
BIOS Menu 12: SATA Configuration	83
BIOS Menu 13: USB Configuration	84
BIOS Menu 14: iEi Feature	85
BIOS Menu 15: F81866 H/W Monitor	86
BIOS Menu 16: Smart Fan Mode Configuration	87
BIOS Menu 17: Chipset	89
BIOS Menu 18: System Agent (SA) Configuration	89
BIOS Menu 19: Graphics Configuration	90
BIOS Menu 20: NB PCIe Configuration	92
BIOS Menu 21: Memory Configuration	93
BIOS Menu 22: PCH-IO Configuration	94
BIOS Menu 23: PCI Express Configuration	95
BIOS Menu 24: HD Audio Configuration	97
BIOS Menu 25: Security	98
BIOS Menu 26: Boot	99
BIOS Menu 27: Exit	101
BIOS Menu 28: Server Mgmt	102
BIOS Menu 29: System Event Log	103
BIOS Menu 30: PCH Azalia Configuration Menu	104

Chapter

1

Introduction

1.1 Overview



Figure 1-1: TANK-870-Q170 Series

The TANK-870-Q170 Series is an embedded system for wide range temperature environments. It is powered by the 6th generation Intel® Core™ processor, uses the Intel® Q170 chipset and supports two 260-pin DDR4 SDRAM SO-DIMM modules up to 64 GB (4GB memory preinstalled). The TANK-870-Q170 Series includes one VGA port, one HDMI+DP port, one iDP port (optional) , two GbE LAN ports, four USB 3.0 ports, four USB 2.0 ports, four RS-232 connectors and two RS-232/422/485 connectors.

1.2 Model Variations

The model variations of the TANK-870-Q170 Series series are listed below.

Model No.	CPU	Expansion Slots
TANK-870-Q170i-i5/4G/2A-R10	Intel® Core™ i5-6500TE 2.3GHz (up to 3.3 GHz, Quad Core, TDP 35W)	2 x PCIe by 8 expansion,
TANK-870-Q170i-i5/4G/2B-R10		1 x PCIe by 16 & 1 x PCI expansion
TANK-870-Q170i-i5/4G/4A-R10		2 x PCIe by 8 & 2 x PCI expansion
TANK-870-Q170i-i5/4G/4B-R10		1 x PCIe by 16 & 3 x PCI expansion
TANK-870-Q170i-i7/4G/2A-R10	Intel® Core™ i7-6700TE 2.4GHz (up to 3.4 GHz, Quad Core, TDP 35W)	2 x PCIe by 8 expansion
TANK-870-Q170i-i7/4G/2B-R10		1 x PCIe by 16 & 1 x PCI expansion
TANK-870-Q170i-i7/4G/4A-R10		2 x PCIe by 8 & 2 x PCI expansion
TANK-870-Q170i-i7/4G/4B-R10		1 x PCIe by 16 & 3 x PCI expansion

Table 1-1: TANK-870-Q170 Series Model Variations

1.3 Features

The TANK-870-Q170 Series features are listed below:

- 6th Gen Intel® Core™ processor platform with Intel® Q170 chipset and DDR4 memory
- Triple independent display with high resolution support
- Rich high-speed I/O interfaces on one side for easy installation
- On-board internal power connector for providing power to add-on cards
- Great flexibility for hardware expansion

1.4 Technical Specifications

The TANK-870-Q170 Series technical specifications are listed in **Table 1-2**.

Specifications	
Chassis	
Color	Black C + Silver
Dimensions (WxHxD) (mm)	2-slot: 121.5 x 255.2 x 205 4-slot: 154.8 x 255.2 x 205
System Fan	Fanless
Chassis Construction	Extruded aluminum alloy
Motherboard	
CPU	Intel® Core™ i7-6700TE (2.4 GHz, quad-core, TDP=35) Intel® Core™ i5-6500TE (2.3 GHz, quad-core, TDP=35)
Chipset	Intel® Q170
System Memory	2 x 260 pin DDR4 SO-DIMM, one 4 GB pre-installed (system max: 64GB)
IPMI	
iRIS Solution	1 x iRIS-2400 (optional)
Storage	
Hard Drive	2 x 2.5" SATA 6Gb/s HDD/SSD bay (RAID 0/1/5/10 support)
I/O Interfaces	
USB 3.0	4
USB 2.0	4
Ethernet	2 x RJ45 LAN1: Intel® I219LM PCIe controller LAN2 (iRIS): Intel® I210 PCIe controller
COM Port	4 x RS-232 (2 x RJ-45, 2 x DB-9 w/ isolation) 2 x RS-232/422/485 (DB-9)

TANK-870-Q170 Embedded System

Specifications	
Digital I/O	8-bit digital I/O, 4-bit input/4-bit output
Display	1 x VGA 1 x HDMI+DP 1 x iDP (optional)
Resolution	VGA: Up to 1920 x 1200@60Hz HDMI/DP: Up to 4096x2304@60Hz
Audio	1 x Line-out, 1 x Mic-in
Wireless	1 x 802.11 a/b/g/n (optional)
Expansions	
PCI/PCIe	2 slot model: 1 x PCIe x 16 , 1 x PCI 2 slot model: 2 x PCIe x 8 4 slot model: 2 x PCIe x 8 , 2 x PCI, 1 x Full Size Mini PCIe 4 slot model: 1 x PCIe x 16 , 3 x PCI, 1 x Full Size Mini PCIe
PCIe Mini	1 x Half size PCIe mini Card 1 x Full size PCIe mini Card (supports mSATA, colay with SATA)
Power	
Power Input	DC Jack: 9 V~36 V DC Terminal Block: 9 V~36 V DC
Power Consumption	19 V@3.68 A (Intel® Core™ i7-6700TE with 8 GB memory)
Internal Power Connector	5V@3A or 12V@3A
Reliability	
Mounting	Wall mount
Operating Temperature	i7-6700TE -20°C ~ 45°C with air flow (SSD), 10% ~ 95%, non-condensing i5-6500TE -20°C ~ 60°C with air flow (SSD), 10% ~ 95%, non-condensing

Specifications	
Storage Temperature	-40°C ~ 85°C with air flow (SSD), 10% ~ 90%, non-condensing
Operating Shock	Half-sine wave shock 5G; 11ms; 100 shocks per axis
Operating Vibration	MIL-STD-810G 514.6 C-1 (with SSD)
Weight (Net/Gross)	2-slot: 4.2 kg/6.3 kg 4-slot: 4.5 kg/6.5 kg
Safety/EMC	CE/FCC
OS	
Supported OS	Microsoft® Windows® 8 Embedded, Microsoft® Windows® Embedded Standard 7 E

Table 1-2: Technical Specifications

TANK-870-Q170 Embedded System

1.5 Front Panel

1.5.1 TANK-870-Q170-2 slot Front Panel

The front panel of the TANK-870-Q170 Series has the following features (**Figure 1-2**):

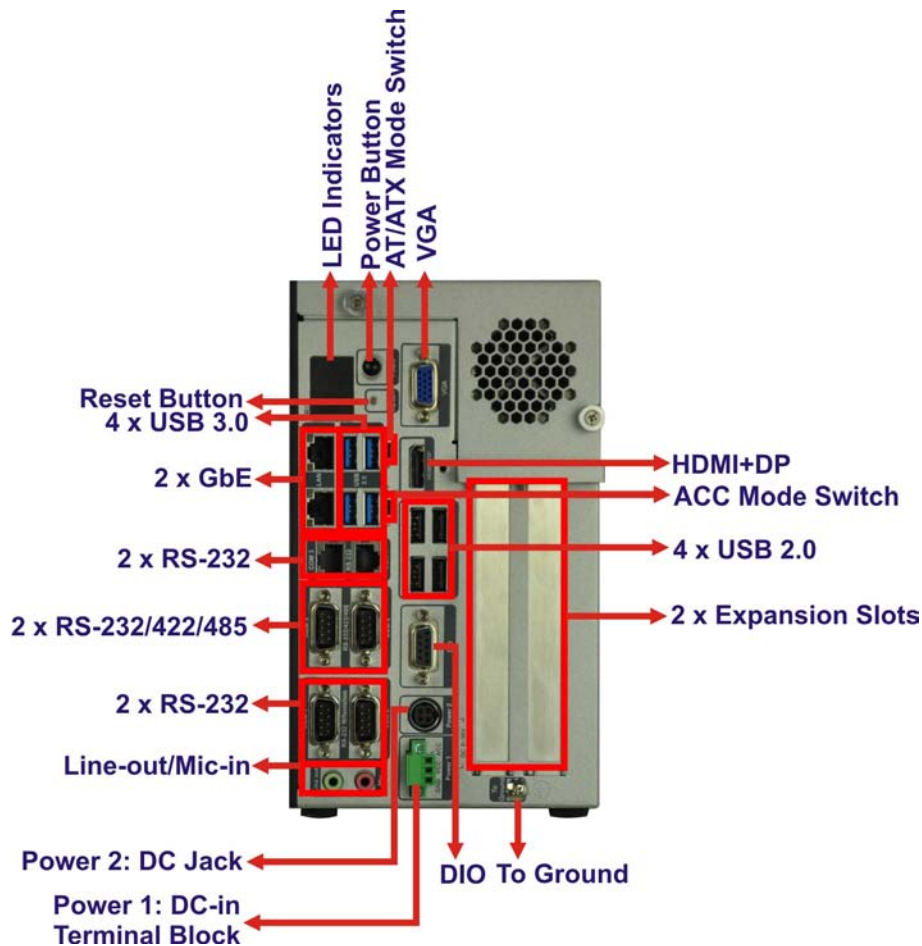

Figure 1-2: TANK-870-Q170 Series Front Panel

Connectors and buttons on the front panel include the following:

- 1 x 4-pin power DC jack for 9 V ~ 36 V power input
- 1 x Power terminal block for 9 V ~ 36 V power input
- 1 x Mic-in port (pink)
- 1 x Line-out port (green)
- 2 x RS-232 serial ports (DB-9)
- 2 x RS-232 serial ports (RJ-45)

- 2 x RS-232/422/485 serial ports (DB-9)
- 2 x Gigabit Ethernet ports (RJ-45)
- 4 x USB 3.0 ports
- 4 x USB 2.0 ports
- 1 x Reset button
- 6 x LED indicators (**Section 1.7**)
- 1 x Power button
- 1 x VGA port
- 1 x HDMI+DP port
- 1 X DIO port
- 1 x To Ground
- 2 x Expansion slots
- 1 x ACC mode switch
- 1 x AT/ATX mode switch

TANK-870-Q170 Embedded System

1.5.2 TANK-870-Q170-4 slot Front Panel

The front panel of the TANK-870-Q170 Series has the following features (**Figure 1-2**):

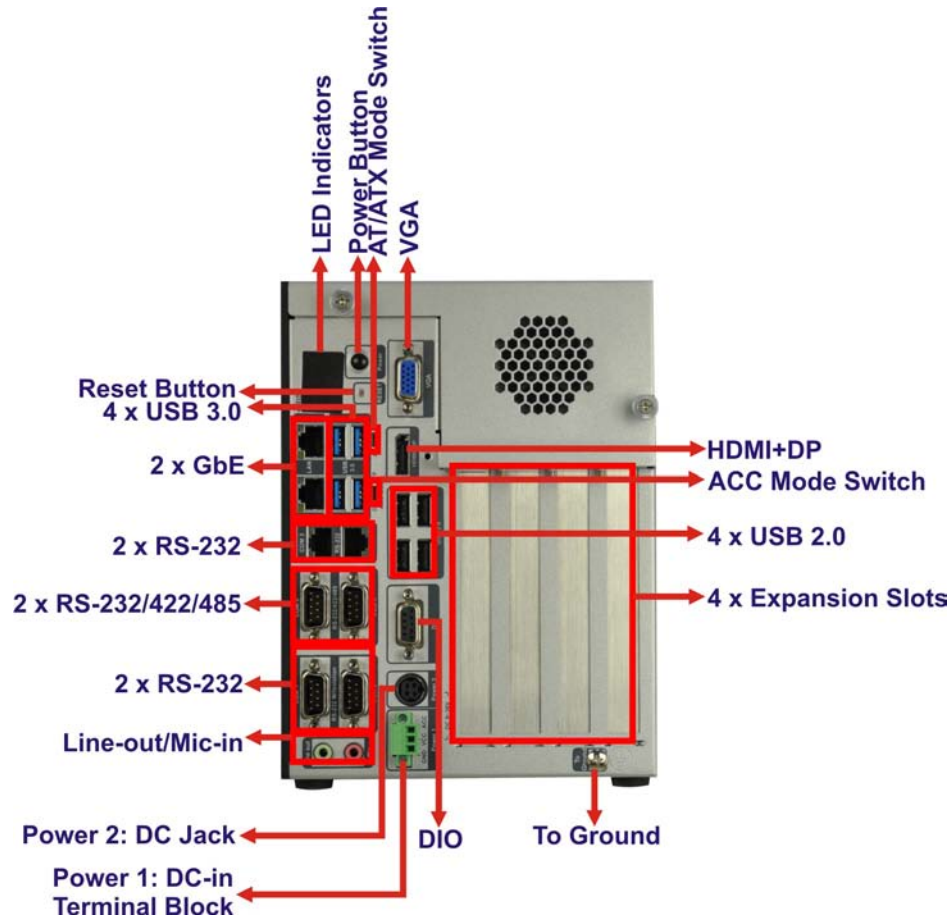

Figure 1-3: TANK-870-Q170 Series Front Panel

Connectors and buttons on the front panel include the following:

- 1 x 4-pin power DC jack for 9 V ~ 36 V power input
- 1 x Power terminal block for 9 V ~ 36 V power input
- 1 x Mic-in port (pink)
- 1 x Line-out port (green)
- 2 x RS-232 serial ports (DB-9)
- 2 x RS-232 serial ports (RJ-45)
- 2 x RS-232/422/485 serial ports (DB-9)
- 2 x Gigabit Ethernet ports (RJ-45)
- 4 x USB 3.0 ports

- 4 x USB 2.0 ports
- 1 x Reset button
- 6 x LED indicators (**Section 1.7**)
- 1 x Power button
- 1 x VGA port
- 1 x HDMI+DP port
- 1 X DIO port
- 1 x To Ground
- 4 x Expansion slots
- 1 x ACC mode switch
- 1 x AT/ATX mode switch

1.6 Rear Panel

The rear panel of the TANK-870-Q170 Series has the following features (**Figure 1-2**):



Figure 1-4: TANK-870-Q170 Series Rear Panel

1.7 LED Indicators

There are several indicators on the rear panel of the TANK-870-Q170 Series as shown in **Figure 1-5**.

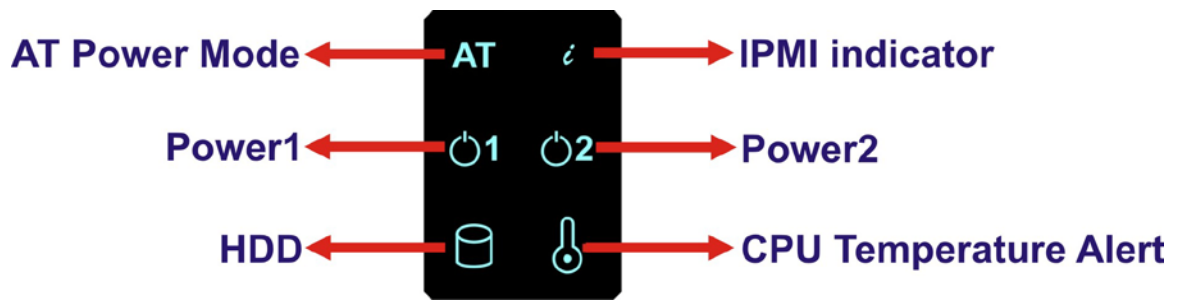

Figure 1-5: TANK-870-Q170 Series LED Indicators

The descriptions of each LED indicator are listed below.

LED Indicator	Description
AT Power Mode	The current power mode status is AT mode. Controlled by the AT/ATX power mode switch.
i	Shows IPMI status.
Power LED1	Breathing Orange: Standby mode.
Power LED2	Solid blue: Power-on mode.
HDD	Shows HDD status.
CPU Temperature Alert	BLUE: CPU temperature is normal. RED: CPU temperature is too high.

Table 1-3: LED Indicators Description



WARNING:

The CPU Temperature Alert LED turns red when the CPU temperature is too high. If this situation occurs, lower the environment temperature or close some running applications to cool down the CPU.

1.8 Backplane Options

The backplane options of the TANK-870-Q170 Series are shown below.

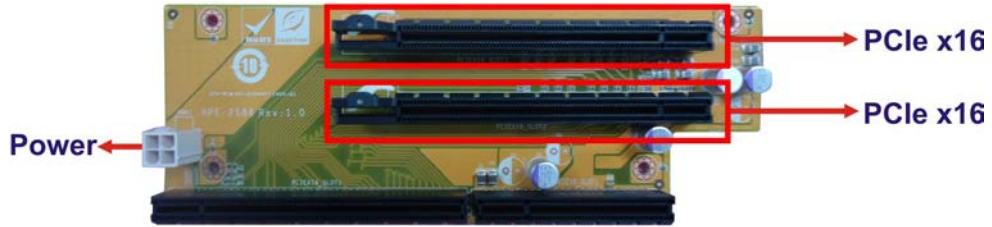
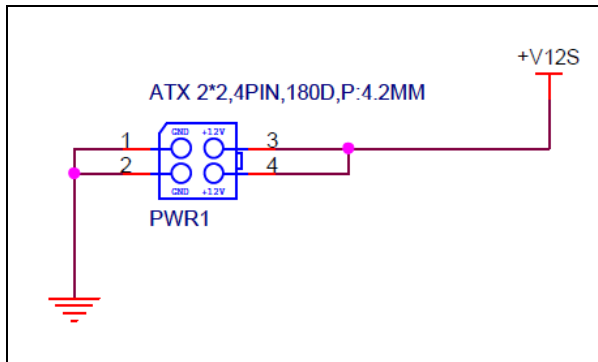

Figure 1-6: HPE-2S86 (for 2A model)

PWR1:



Pin	Description
1	GND
2	GND
3	+12 V
4	+12 V

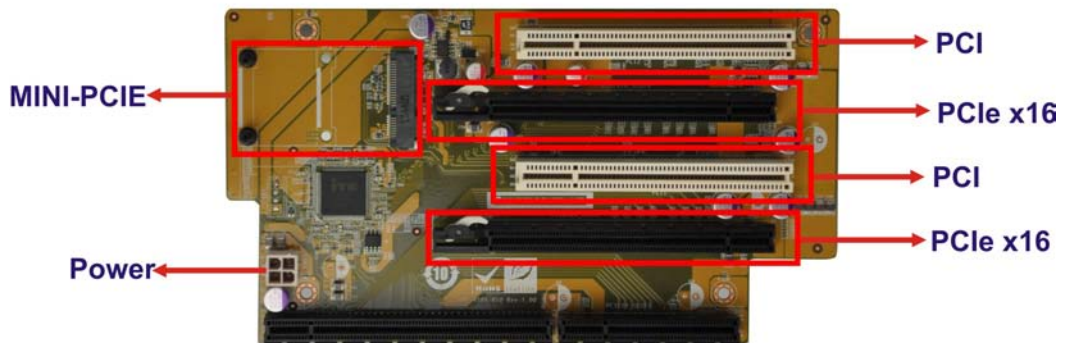
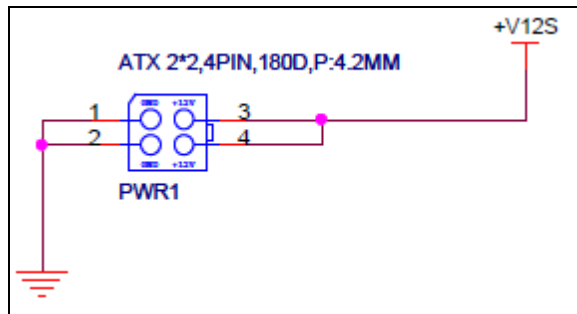

Figure 1-7: HPE-4AS87 (for 4A model)

TANK-870-Q170 Embedded System

PWR1:



Pin	Description
1	GND
2	GND
3	+12 V
4	+12 V

MINI-PCIE1:

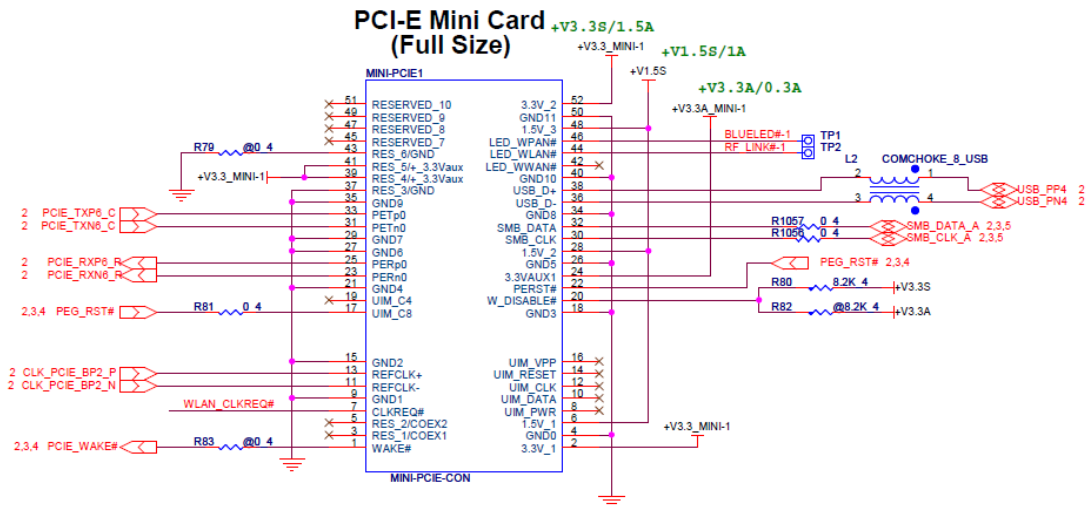

Pin	Description	Pin	Description
1	PCIE_WAKE#	2	VCC3
3	N/C	4	GND
5	N/C	6	1.5 V
7	WLAN_CLKREQ#	8	N/C
9	GND	10	N/C
11	CLK-	12	N/C

Pin	Description	Pin	Description
13	CLK+	14	N/C
15	GND	16	N/C
17	PCIRST#	18	GND
19	N/C	20	VCC3
21	GND	22	PCIRST#
23	PCIE-RXN	24	VCC3
25	PCIE-RXP	26	GND
27	GND	28	1.5 V
29	GND	30	SMBCLK
31	PCIE-TXN	32	SMBDATA
33	PCIE-TXP	34	GND
35	GND	36	USBD-
37	GND	38	USBD+
39	VCC3	40	GND
41	VCC3	42	N/C
43	GND	44	RF_LINK#
45	N/C	46	BLUELED#
47	N/C	48	1.5 V
49	N/C	50	GND
51	N/C	52	VCC3

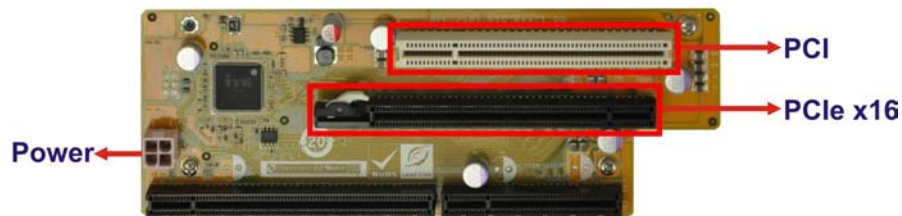
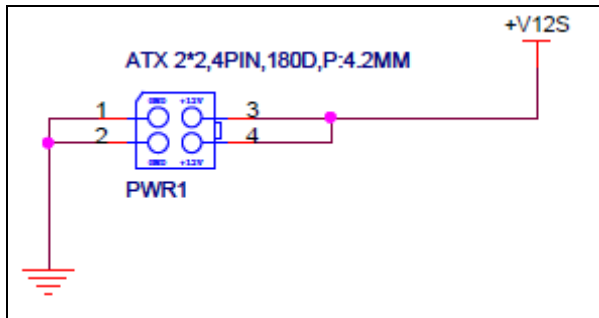

Figure 1-8: HPE-2S87 (for 2B model)

TANK-870-Q170 Embedded System

PWR1:



Pin	Description
1	GND
2	GND
3	+12 V
4	+12 V

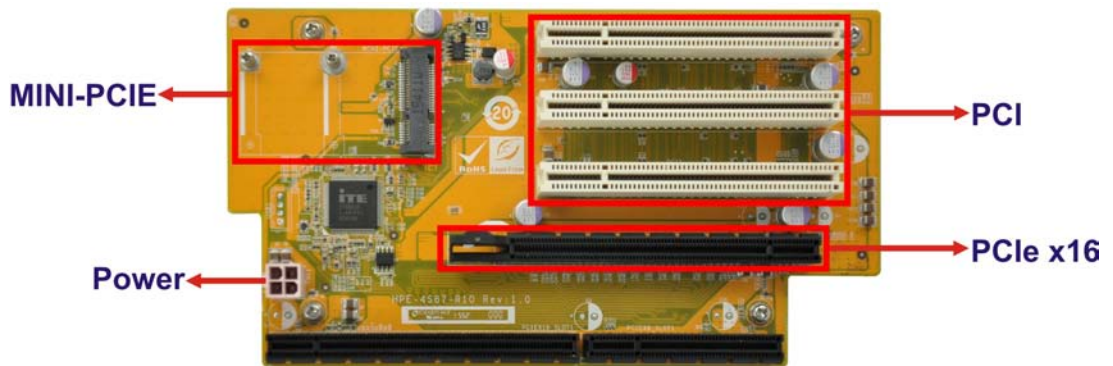
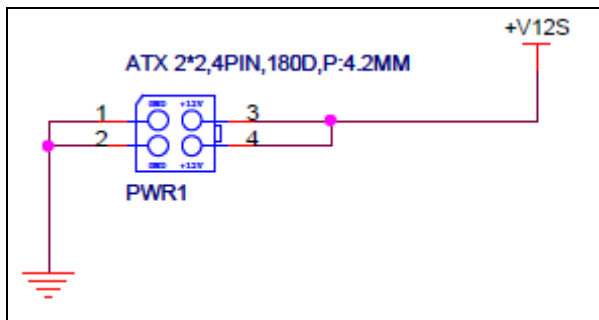

Figure 1-9: HPE-4S87 (for 4B model)

PWR1:



Pin	Description
1	GND
2	GND
3	+12 V
4	+12 V

MINI-PCIE1:

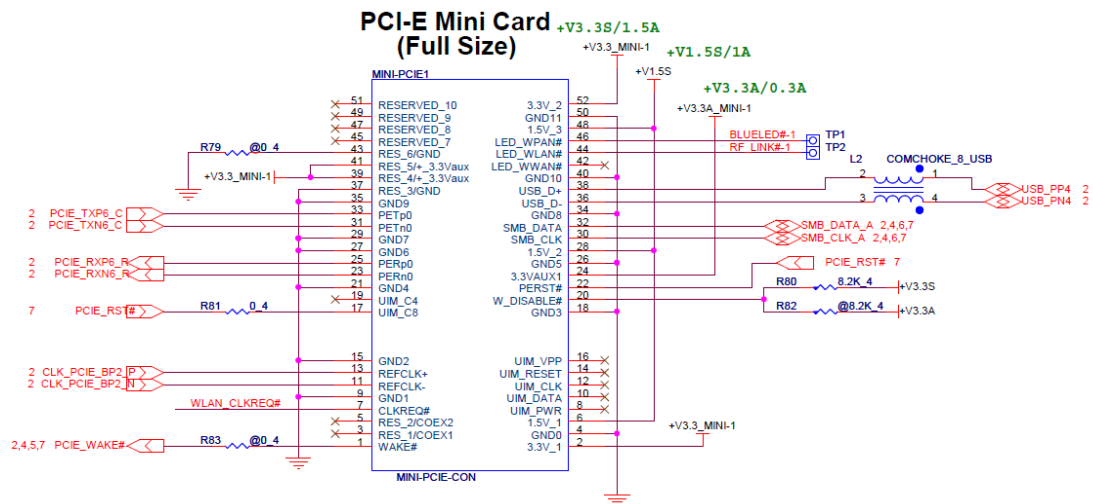

Pin	Description	Pin	Description
1	PCIE_WAKE#	2	VCC3
3	N/C	4	GND
5	N/C	6	1.5 V
7	WLAN_CLKREQ#	8	N/C
9	GND	10	N/C
11	CLK-	12	N/C
13	CLK+	14	N/C
15	GND	16	N/C
17	PCIRST#	18	GND
19	N/C	20	VCC3
21	GND	22	PCIRST#
23	PCIE-RXN	24	VCC3
25	PCIE-RXP	26	GND

TANK-870-Q170 Embedded System

Pin	Description	Pin	Description
27	GND	28	1.5 V
29	GND	30	SMBCLK
31	PCIE-TXN	32	SMBDATA
33	PCIE-TXP	34	GND
35	GND	36	USBD-
37	GND	38	USBD+
39	VCC3	40	GND
41	VCC3	42	N/C
43	GND	44	RF_LINK#
45	N/C	46	BLUELED#
47	N/C	48	1.5 V
49	N/C	50	GND
51	N/C	52	VCC3

The supported signals of the backplane slots are listed below.

Backplane	Slot	Signal
HPE-2S86 (for 2A model)	PCIe x16	PCIe x8
	PCIe x16	PCIe x8
HPE-4AS87 (for 4A model)	PCIe x16	PCIe x8
	PCIe x16	PCIe x8
	PCI	PCI
	PCI	PCI
HPE-2S87 (for 2B model)	PCIe x16	PCIe x16
	PCI	PCI
HPE-4S87 (for 4B model)	PCIe x16	PCIe x16
	PCI	PCI
	PCI	PCI
	PCI	PCI

Table 1-4: Supported Signals

The rated voltage and current of the backplanes are listed below.

Rated Voltage	Rated Current
+5 V	4.0 A
+12 V	2.5 A
-12 V	0.1 A
+3.3 V	5.0 A

Table 1-5: Rated Voltage and Current



WARNING:

The system default power is 120 W. The maximum total power of the backplane to support expansion cards is 45 W. The power of the selected expansion cards can not exceed the max. power (45 W), otherwise, the system may be unstable.



NOTE:

When using an expansion card with high power consumption, it is recommended to install an external power supply to the power input connector on the backplane.

The four types of backplane support standard PCI/PCIe cards with maximum dimensions (WxL):110 x 230 mm.

The TANK-870-Q170 provides the most convenient 4-pin internal power connector for add-on card usage, adding more flexibility to the embedded system in industrial environment. The internal power connector supports 5V@3A or 12V@3A power supply.

TANK-870-Q170 Embedded System

1.9 Physical Dimensions

The following sections describe the physical dimensions for each model of the TANK-870-Q170 Series.

1.9.1 TANK-870-Q170-2 slot Physical Dimensions

The physical dimensions of the TANK-870-Q170-2 slot are shown in **Figure 1-11**.

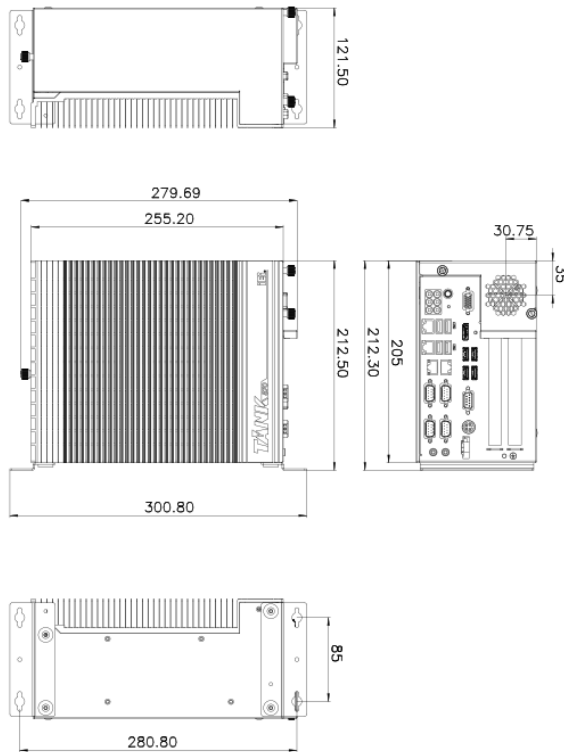

Figure 1-10: TANK-870-Q170-2 slot Physical Dimensions (millimeters)

1.9.2 TANK-870-Q170-4 slot Physical Dimensions

The physical dimensions of the TANK-870-Q170-4 slot are shown in **Figure 1-12**.

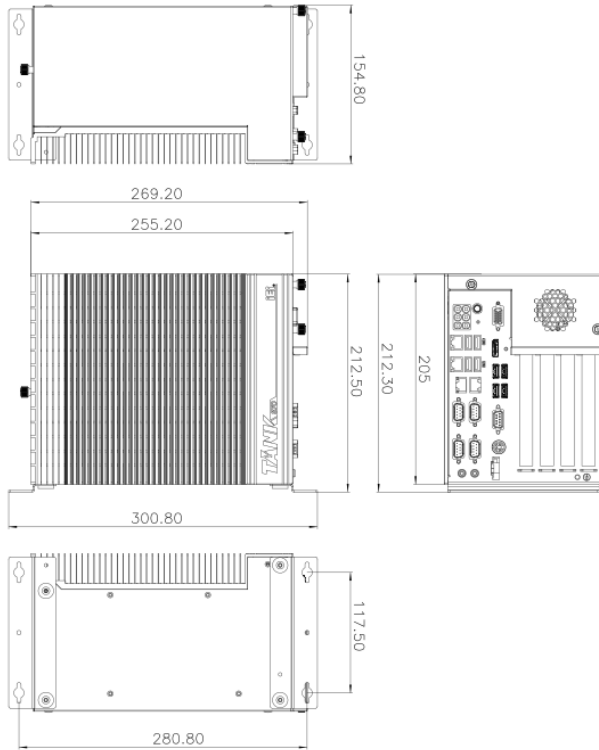

Figure 1-11: TANK-870-Q170-4 slot Physical Dimensions (millimeters)

Chapter

2

Unpacking

2.1 Anti-static Precautions



WARNING:

Failure to take ESD precautions during installation may result in permanent damage to the TANK-870-Q170 Series and severe injury to the user.

Electrostatic discharge (ESD) can cause serious damage to electronic components, including the TANK-870-Q170 Series. Dry climates are especially susceptible to ESD. It is therefore critical that whenever the TANK-870-Q170 Series or any other electrical component is handled, the following anti-static precautions are strictly adhered to.

- **Wear an anti-static wristband:** Wearing a simple anti-static wristband can help to prevent ESD from damaging the board.
- **Self-grounding:** Before handling the board touch any grounded conducting material. During the time the board is handled, frequently touch any conducting materials that are connected to the ground.
- **Use an anti-static pad:** When configuring the TANK-870-Q170 Series, place it on an anti-static pad. This reduces the possibility of ESD damaging the TANK-870-Q170 Series.

2.2 Unpacking Precautions

When the TANK-870-Q170 Series is unpacked, please do the following:

- Follow the anti-static precautions outlined in **Section 2.1**.
- Make sure the packing box is facing upwards so the TANK-870-Q170 Series does not fall out of the box.
- Make sure all the components shown in **Section 2.3** are present.

2.3 Unpacking Checklist





NOTE:





If some of the components listed in the checklist below are missing, please do not proceed with the installation. Contact the IEI reseller or vendor you purchased the TANK-870-Q170 Series from or contact an IEI sales representative directly. To contact an IEI sales representative, please send an email to sales@ieiworld.com.

The TANK-870-Q170 Series is shipped with the following components:







Quantity	Item and Part Number	Image
Standard		
1	TANK-870-Q170 Series	
2	Mounting Brackets	
1	Chassis Screw	



Quantity	Item and Part Number	Image
Standard		
1	HDMI Security Holder	
1	One Key Recovery CD	
1	User Manual and Driver CD	

The following table lists the optional items that can be purchased separately.

Optional	
European power cord (P/N: 32702-000400-200-RS)	
Power adapter, <i>FSP120-ABBN2, 9NA1205302, Active PFC, Vin:90~264VAC, 120W, plug=6.5mm, cable=1500mm, Erp (no load 0.15W), Vout:19VDC, 4-pin DIN with lock, CCL, RoHS</i> (P/N: 63040-010120-210-RS)	
Fan, <i>+12V DC, 4-pin, 40 mm x 40 mm x10 mm, 6500RPM, RoHS</i> (P/N: 19Z00-000605-00-RS)	
IPMI 2.0 adapter card with AST2400 BMC chip for DDR3 SO-DIMM socket interface (P/N: iRIS-2400-R10)	

TANK-870-Q170 Embedded System

Optional	
<p>1T1R Wi-Fi module kit for embedded system, IEEE802.11b/g/n, 1 x Wi-Fi module, 2 x RF cable, 2 x Antenna, RoHs (P/N: EMB-WIFI-KIT01-R11)</p>	
<p>DisplayPort to DisplayPort converter board (For iEi IDP connector) (P/N: DP-DP-R10)</p>	
<p>DisplayPort to HDMI converter board (For iEi IDP connector) (P/N: DP-HDMI-R10)</p>	
<p>DisplayPort to 24 bit dual channel LVDS converter board (For iEi IDP connector) (P/N: DP-LVDS-R10)</p>	
<p>DisplayPort to VGA converter board (For iEi IDP connector) (P/N: DP-VGA-R10)</p>	
<p>DisplayPort to DVI-D converter board (For iEi IDP connector) (P/N: DP-DVI-R10)</p>	

Optional	
<p>PCI Express Power over Ethernet frame grabber card, 4-port 1000 Base(T), 802.3af compliant, RoHS</p> <p><i>Note: * The operating Temperature can be support up to 40 degrees when installing IPCIE-4POE-R10.</i></p> <p>(P/N: IPCIE-4POE-R10)</p>	
<p>20-pin Infineon TPM module, S/W management tool, firmware v3.17</p> <p>(P/N: TPM-IN01-R20)</p>	

Chapter

3

Installation

3.1 Installation Precautions

During installation, be aware of the precautions below:

- **Read the user manual:** The user manual provides a complete description of the TANK-870-Q170 Series, installation instructions and configuration options.
- **DANGER! Disconnect Power:** Power to the TANK-870-Q170 Series must be disconnected during the installation process, or before any attempt is made to access the rear panel. Electric shock and personal injury might occur if the rear panel of the TANK-870-Q170 Series is opened while the power cord is still connected to an electrical outlet.
- **Qualified Personnel:** The TANK-870-Q170 Series must be installed and operated only by trained and qualified personnel. Maintenance, upgrades, or repairs may only be carried out by qualified personnel who are familiar with the associated dangers.
- **Air Circulation:** Make sure there is sufficient air circulation when installing the TANK-870-Q170 Series. The TANK-870-Q170 Series's cooling vents must not be obstructed by any objects. Blocking the vents can cause overheating of the TANK-870-Q170 Series. Leave at least 5 cm of clearance around the TANK-870-Q170 Series to prevent overheating.
- **Grounding:** The TANK-870-Q170 Series should be properly grounded. The voltage feeds must not be overloaded. Adjust the cabling and provide external overcharge protection per the electrical values indicated on the label attached to the back of the TANK-870-Q170 Series.

3.2 Hard Disk Drive (HDD) Installation

To install the hard drive, please follow the steps below:

- Step 1:** Loosen the two thumbscrews on the front panel, slide the cover outward, and then lift the cover up gently (**Figure 3-1**).

TANK-870-Q170 Embedded System



Figure 3-1: Unscrew the Cover

Step 2: Unplug the SATA signal and power cables connected to the TANK-870-Q170 Series, and then put the cover on a flat surface (**Figure 3-2**).

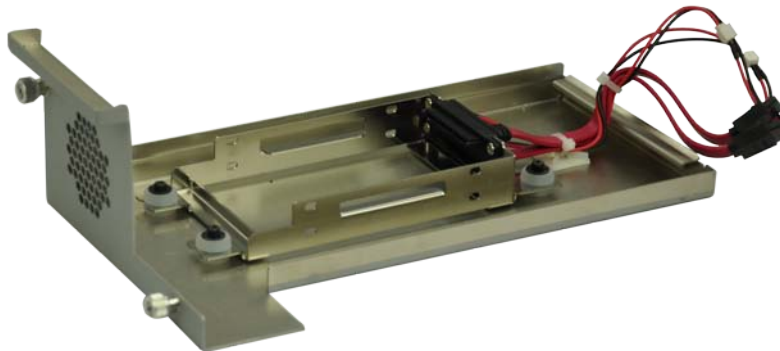

Figure 3-2: Remove the Cover from TANK-870-Q170 Series

Step 3: Attach the HDD to the HDD bracket, and then slide the HDD to connect with the SATA connector (**Figure 3-3**).

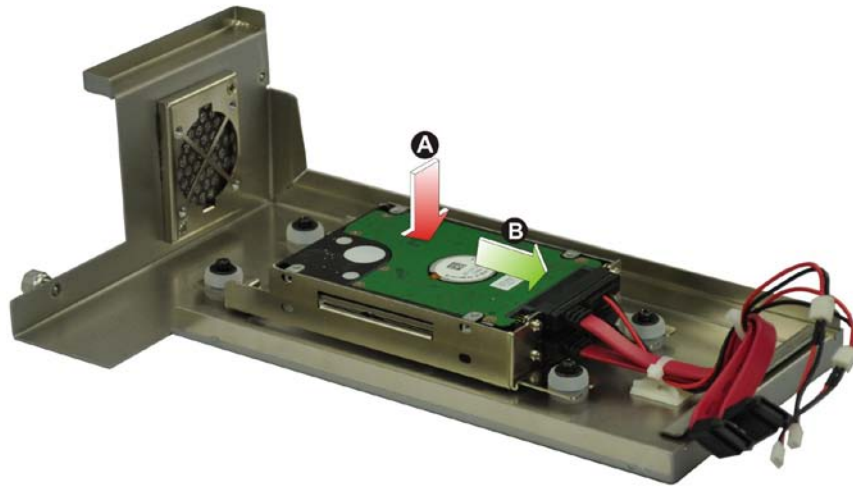

Figure 3-3: HDD Installation

Step 4: Secure the HDD with the HDD bracket by four retention screws (**Figure 3-4**).

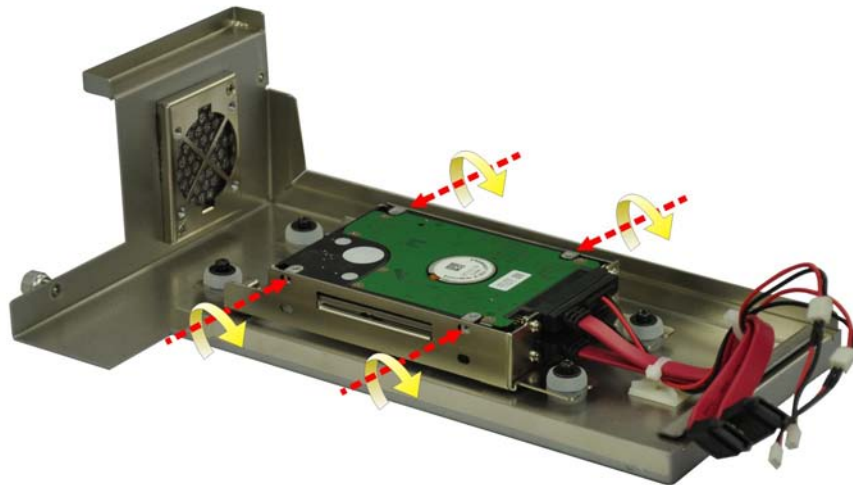

Figure 3-4: HDD Retention Screws

Step 5: Reconnect the SATA signal and power cables to the TANK-870-Q170 Series.

Step 6: Reinstall the cover.

3.3 System Fan Installation

To install the optional system fan, please follow the steps below:

TANK-870-Q170 Embedded System

- Step 1:** Loosen the two thumbscrews on the front panel, slide the cover outward, and then lift the cover up gently (**Figure 3-1**).
- Step 2:** Unplug the SATA signal and power cables connected to the TANK-870-Q170 Series, and then place the cover on a flat surface (**Figure 3-2**).
- Step 3:** Attach the system fan to the TANK-870-Q170 Series and secure it by four retention screws (**Figure 3-5**).

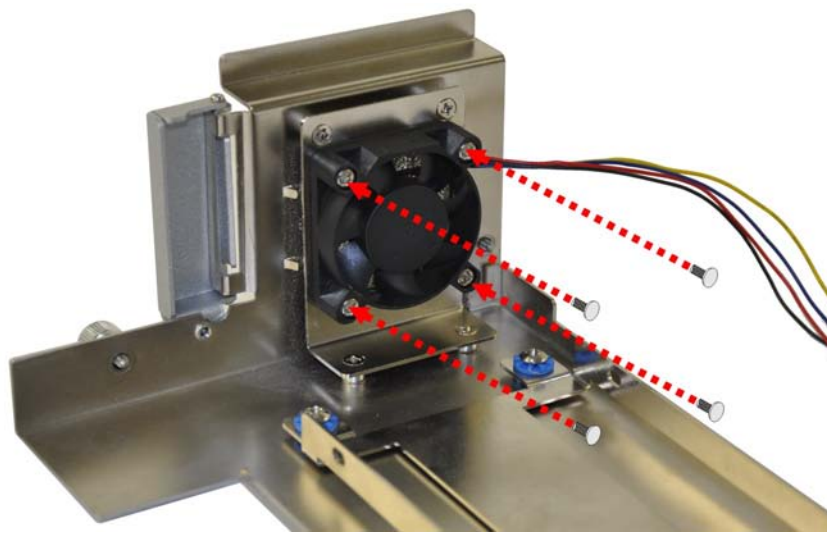

Figure 3-5: System Fan Installation

- Step 4:** Connect the system fan cable to the **CPU_FAN1** connector on the motherboard of TANK-870-Q170 Series.
- Step 5:** Reconnect the SATA signal and power cables to the TANK-870-Q170 Series.
- Step 6:** Reinstall the cover.

3.4 Mounting the System with Mounting Brackets

To mount the embedded system onto a wall or some other surface using the two mounting brackets, please follow the steps below.

- Step 1:** Turn the embedded system to the left side panel.

Step 2: Align the two retention screw holes in each bracket with the corresponding retention screw holes on the bottom surface or the left side panel (**Figure 3-6**).

Left Side Panel



Figure 3-6: Mounting Bracket Retention Screws

- Step 3:** Secure the brackets to the system by inserting two retention screws into each bracket (**Figure 3-6**).
- Step 4:** Drill holes in the intended installation surface.
- Step 5:** Align the mounting holes in the sides of the mounting brackets with the predrilled holes in the mounting surface.
- Step 6:** Insert four retention screws, two in each bracket, to secure the system to the wall.

3.5 External Peripheral Interface Connectors

The TANK-870-Q170 Series has the following connectors. Detailed descriptions of the connectors can be found in the subsections below.

- ACC mode switch
- AT/ATX power mode switch
- Audio
- DIO
- Ethernet

TANK-870-Q170 Embedded System

- Power button
- Power DC jack
- Power terminal block
- RS-232
- RS-232/422/485
- USB
- VGA

3.5.1 ACC Mode Selection

The ACC mode is designed for vehicle applications. The TANK-870-Q170 Series allows turning the ACC mode on or off. The setting can be made through the ACC mode switch on the external peripheral interface panel as shown below.

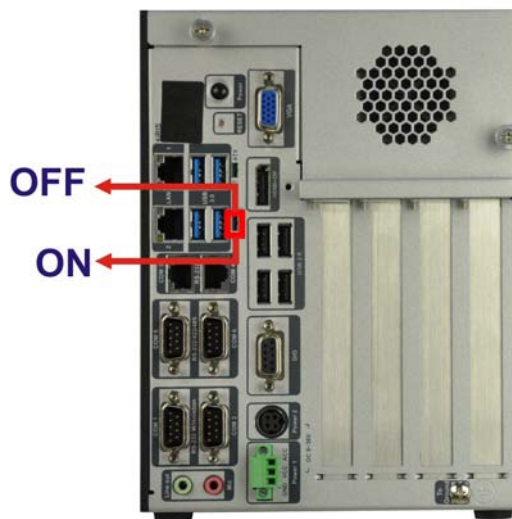

Figure 3-7: ACC Mode Switch

3.5.2 AT/ATX Power Mode Selection

The TANK-870-Q170 Series supports AT and ATX power modes. The setting can be made through the AT/ATX power mode switch on the external peripheral interface panel as shown below.

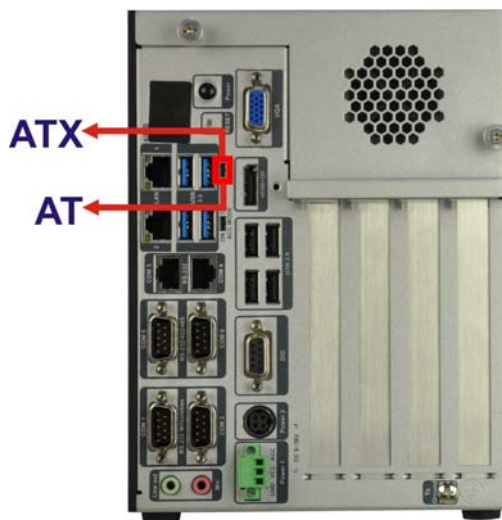

Figure 3-8: AT/ATX Power Mode Switch

3.5.3 Audio Connector

The audio jacks connect to external audio devices.

- **Line Out port (Green):** Connects to a headphone or a speaker. With multi-channel configurations, this port can also connect to front speakers.
- **Microphone (Pink):** Connects a microphone.



Figure 3-9: Audio Connector

TANK-870-Q170 Embedded System

3.5.4 Digital Input/Output Connector

The digital I/O connector provides programmable input and output for external devices. The pinouts for the digital I/O connector are listed in the table below.

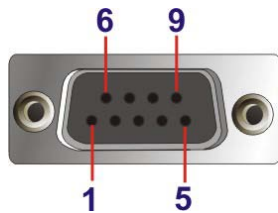

Figure 3-10: DIO Connector

3.5.5 LAN Connectors

The LAN connectors allow connection to an external network.

Step 1: **Locate the RJ-45 connectors.** The locations of the RJ-45 connectors are shown in **Figure 1-2**.

Step 2: **Align the connectors.** Align the RJ-45 connector on the LAN cable with one of the RJ-45 connectors on the TANK-870-Q170 Series. See **Figure 3-11**.

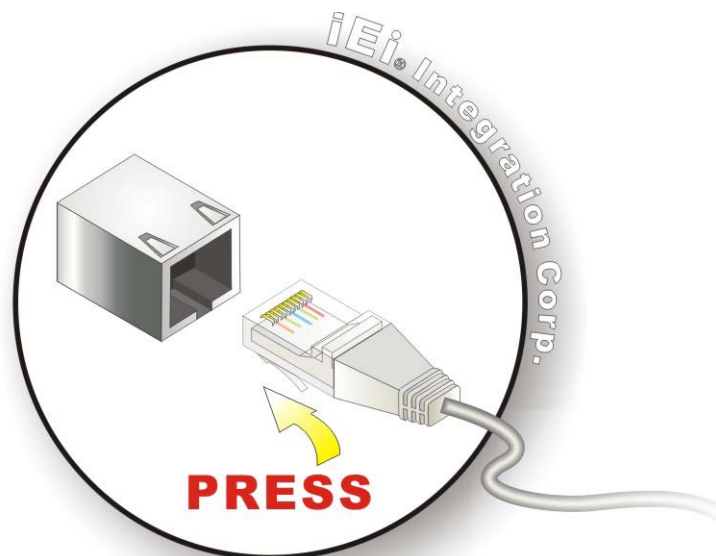

Figure 3-11: LAN Connection

Step 3: Insert the LAN cable RJ-45 connector. Once aligned, gently insert the LAN cable RJ-45 connector into the on-board RJ-45 connector.



Figure 3-12: RJ-45 Ethernet Connector

The RJ-45 Ethernet connector has two status LEDs, one green and one yellow. The green LED indicates activity on the port and the yellow LED indicates the port is linked. See **Table 3-1**.

Activity/Link LED		Speed LED	
STATUS	DESCRIPTION	STATUS	DESCRIPTION
Off	No link	Off	10 Mbps connection
Yellow	Linked	Green	100 Mbps connection
Blinking	TX/RX activity	Orange	1 Gbps connection

Table 3-1: RJ-45 Ethernet Connector LEDs

3.5.6 Power Input, 3-pin Terminal Block

The power connector connects the leads of a 9 V~36 V DC power supply into the terminal block. Make sure that the power and ground wires are attached to the correct sockets of the connector.

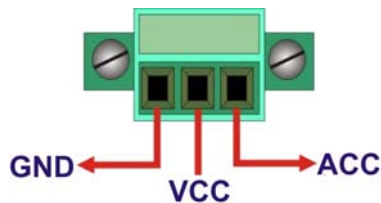

Figure 3-13: 3-pin Terminal Block

TANK-870-Q170 Embedded System

3.5.7 Power Input, 4-pin DIN Connector

The power connector connects to the 9 V~36 V DC power adapter.



Figure 3-14: Power Input Connector

3.5.8 RJ-45 RS-232 Serial Ports

RS-232 serial port devices can be attached to the RJ-45 RS-232 serial ports on the rear panel.

Step 1: **Locate the RJ-45 RS-232 connectors.** The locations of the RJ-45 RS-232 connectors are shown in **Figure 1-2**.

Step 2: **Insert the RJ-45 connector.** Insert the RJ-45 connector on the RJ-45 to DB-9 COM port cable to one of the RJ-45 RS-232 connectors on the TANK-870-Q170 Series. See **Figure 3-15**.

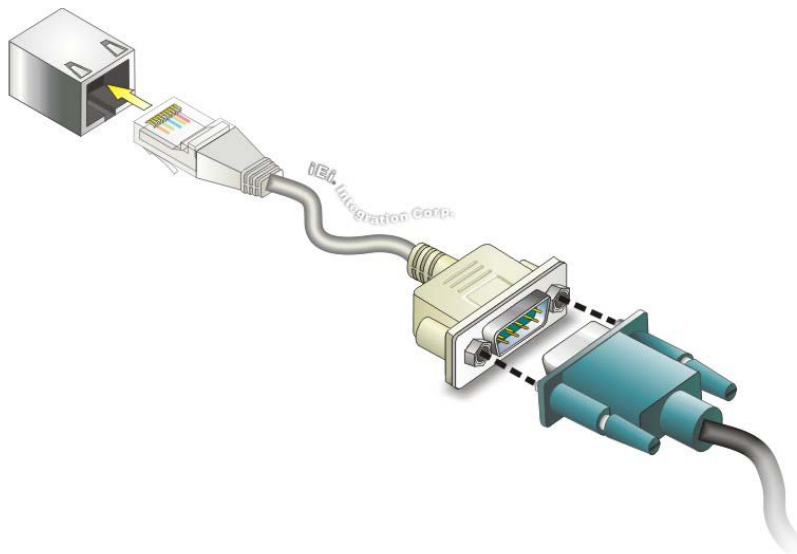

Figure 3-15: RJ-45 RS-232 Serial Device Connection

Step 3: Insert the serial connector. Insert the DB-9 connector of a serial device into the DB-9 connector on the RJ-45 to DB-9 COM port cable.

Step 4: Secure the connector. Secure the serial device connector to the external interface by tightening the two retention screws on either side of the connector.

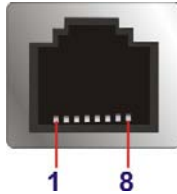

Figure 3-16: RJ-45 RS-232 Serial Port Connector

3.5.9 DB-9 RS-232/422/485 Serial Port Connectors

DB-9 RS-232/422/485 serial port devices can be attached to the DB-9 ports on the rear panel.

Step 1: Locate the DB-9 connector. The locations of the DB-9 connectors are shown in Figure 1-2.

Step 2: Insert the serial connector. Insert the DB-9 connector of a serial device into the DB-9 connector on the external peripheral interface. See Figure 3-17.

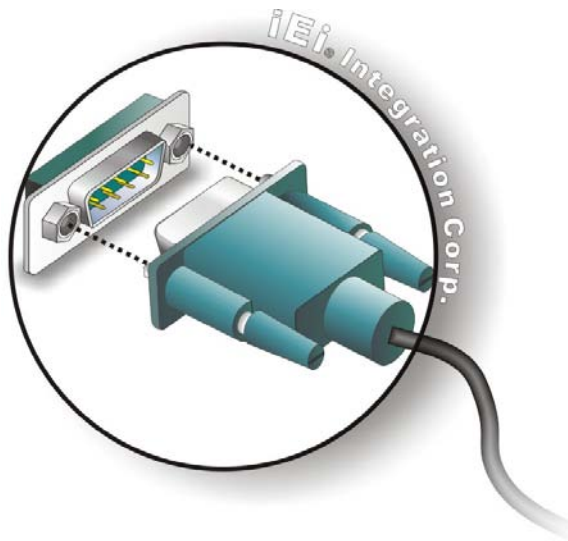

Figure 3-17: Serial Device Connector

TANK-870-Q170 Embedded System

Step 3: Secure the connector. Secure the serial device connector to the external interface by tightening the two retention screws on either side of the connector.

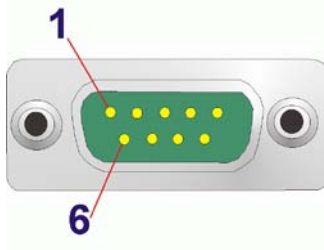

Figure 3-18: DB-9 RS-232/422/485 Serial Port Connector

3.5.10 USB Connectors

The USB ports are for connecting USB peripheral devices to the system.

Step 4: Locate the USB connectors. The locations of the USB connectors are shown in **Figure 1-2**.

Step 5: Align the connectors. Align the USB device connector with one of the connectors. See **Figure 3-19**.

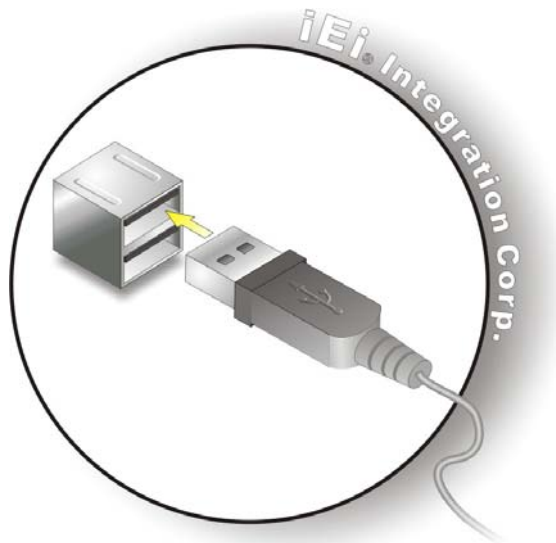

Figure 3-19: USB Device Connection

Step 6: Insert the device connector. Once aligned, gently insert the USB device connector into the on-board connector.

3.5.11 VGA Connector

The VGA connector connects to a monitor that accepts VGA video input.

Step 1: Locate the female DB-15 connector. The location of the female DB-15 connector is shown in **Figure 1-2**.

Step 2: Align the VGA connector. Align the male DB-15 connector on the VGA screen cable with the female DB-15 connector on the external peripheral interface.

Step 3: Insert the VGA connector Once the connectors are properly aligned with, insert the male connector from the VGA screen into the female connector on the TANK-870-Q170 Series. See **Figure 3-20**.

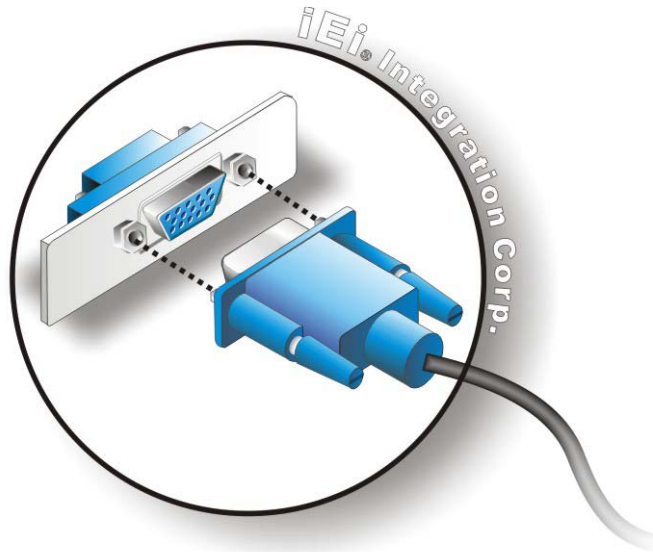

Figure 3-20: VGA Connector

Step 4: Secure the connector. Secure the DB-15 VGA connector from the VGA monitor to the external interface by tightening the two retention screws on either side of the connector.

TANK-870-Q170 Embedded System

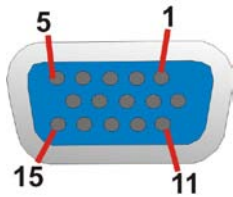

Figure 3-21: VGA Connector

3.6 Internal Peripheral Interface Connectors

3.6.1 iDP Module Installation

Through the IEI iDP converter cards, the iDP connector can support different display specifications, such as VGA, HDMI, DVI-D, LVDS and DisplayPort. To connect an iDP module to TANK-870-Q170 Series please follow the instructions below.

Step 1: Loosen the two thumbscrews on the front panel, slide the cover outward, and then lift the cover up gently (**Figure 3-1**).

Step 2: Locate the internal DisplayPort connector. The location of the internal DisplayPort connector is shown in **Figure 3-22**.

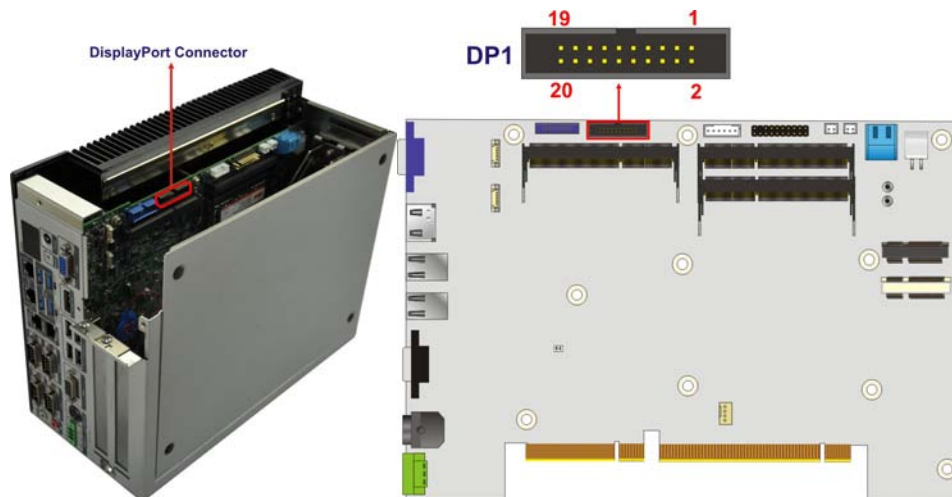

Figure 3-22: Internal DisplayPort Connector Location

Step 3: Secure the iDP module with the bracket by tightening the two retention screws on either side of the iDP module.

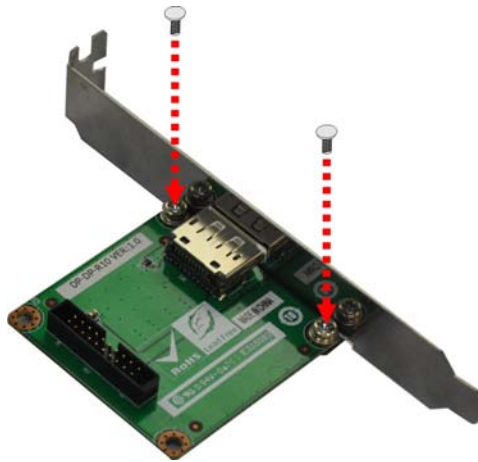

Figure 3-23: iDP Module with Bracket

Step 4: Connect the iDP module to the DisplayPort connector on the motherboard. See **Figure 3-24**.



Figure 3-24: iDP Module Installation

Step 5: Remove the retention screws on the expansion slot bracket. See **Figure 3-25**.

TANK-870-Q170 Embedded System



Figure 3-25: Remove Expansion Slot Bracket

Step 6: Secure the iDP module with bracket to the system. See **Figure 3-26**.



Figure 3-26: Secure iDP Module to System

Step 7: Reinstall the cover.



WARNING:

Installing the iDP module will occupy one expansion slot.

The following table lists the iDP converter cards that can be installed to the system.





DisplayPort to HDMI converter board (for IEI iDP connector) (P/N: DP-HDMI-R10)	
DisplayPort to LVDS converter board (for IEI iDP connector) (P/N: DP-LVDS-R10)	
DisplayPort to VGA converter board (for IEI iDP connector) (P/N: DP-VGA-R10)	
DisplayPort to DVI-D converter board (for IEI iDP connector) (P/N: DP-DVI-R10)	
DisplayPort to DisplayPort converter board (for IEI iDP connector) (P/N: DP-DP-R10)	

Table 3-2: iDP Converter Cards

3.7 Powering On/Off the System

**WARNING:**

Make sure a power supply with the correct input voltage is being fed into the system. Incorrect voltages applied to the system may cause damage to the internal electronic components and may also cause injury to the user.

- **Power on** the system: press the power button for 3 seconds
- **Power off** the system: press the power button for 6 seconds



Figure 3-27: Power Button

3.8 Power

There are two power connectors on the rear panel. Power 1 connector is a 3-pin terminal block that supports ACC On signal. Power 2 connector is a DIN connector that can directly connect to a power adapter. The supported power input voltages are:

- **Power 1 (terminal block):** 9 V ~ 36 V
- **Power 2 (DC jack):** 9 V ~ 36 V

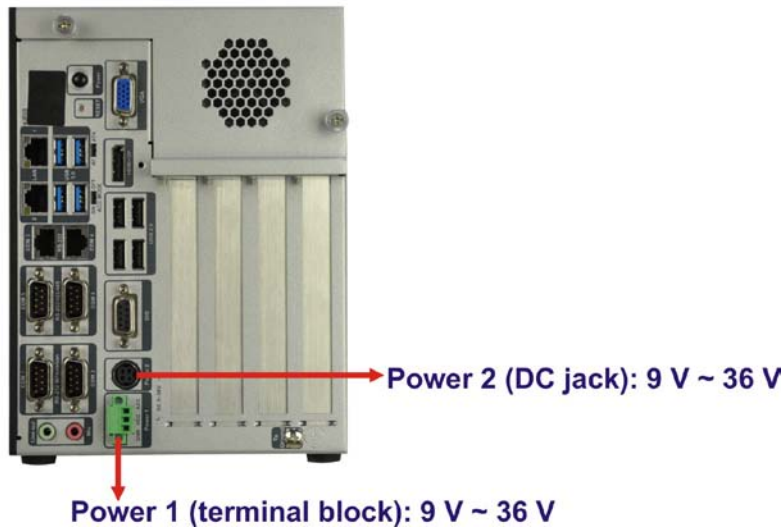

Figure 3-28: Power Connectors

LED Indicator	Description
Power LED1 (Breathing Orange)	Standby mode.
Power LED2 (Solid blue)	Power-on mode.

Table 3-3: Power LED Indicators Description



NOTE:

The power LED turns off when the power cable is unplugged from the system.

3.8.1 ACC ON Mode

1. The TANK-870-Q170 Series supports single power input and also can be simultaneously connected to two power sources. When both power connectors are connected to power sources with 9 V~36 V power input, the one with higher voltage will supply power to the system.
2. If ACC signal is low, the system will not boot up. If ACC ON signal is high (9 V~36 V), the system will boot up and work normally.

TANK-870-Q170 Embedded System

3. If ACC signal jumps from high to low during the power on process, the system will soft shut down and shut down the system power after 10s.
4. When Power 1 < 9 V and Power 2 < 9 V, the system will soft shut down and shut down the system power after 10s.

3.8.2 ACC OFF Mode

1. The TANK-870-Q170 Series supports single power input and also can be simultaneously connected to two power sources. When both power connectors are connected to power sources with 9 V~36 V power input, the one with higher voltage will supply power to the system.
2. When Power 1 < 9 V and Power 2 < 9 V, the system will soft shut down and shut down the system power after 10s.

Chapter

4

System Motherboard

TANK-870-Q170 Embedded System

4.1 Overview

This chapter details all the jumpers and connectors of the system motherboard.

4.1.1 Layout

The figures below show all the connectors and jumpers of the system motherboard. The Pin 1 locations of the on-board connectors are also indicated in the diagram below.

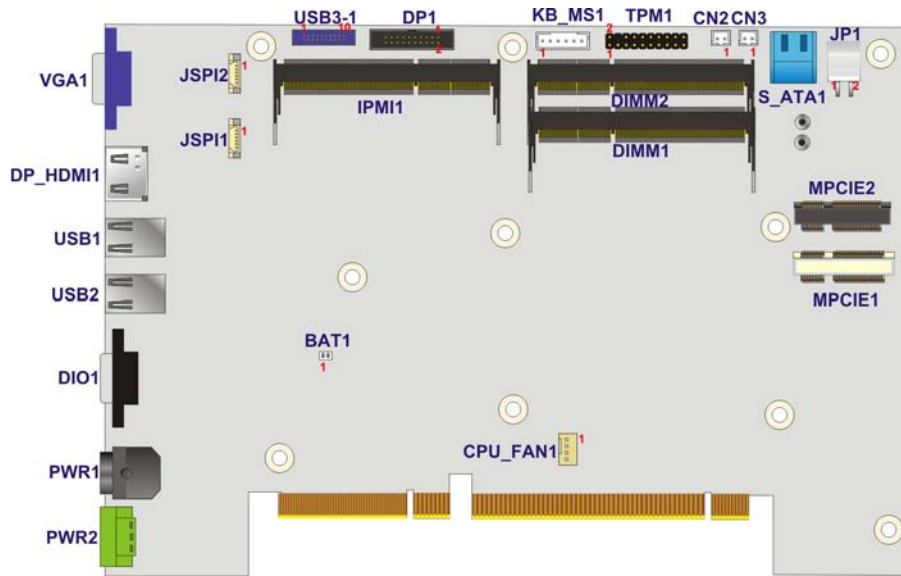

Figure 4-1: System Motherboard (Front)

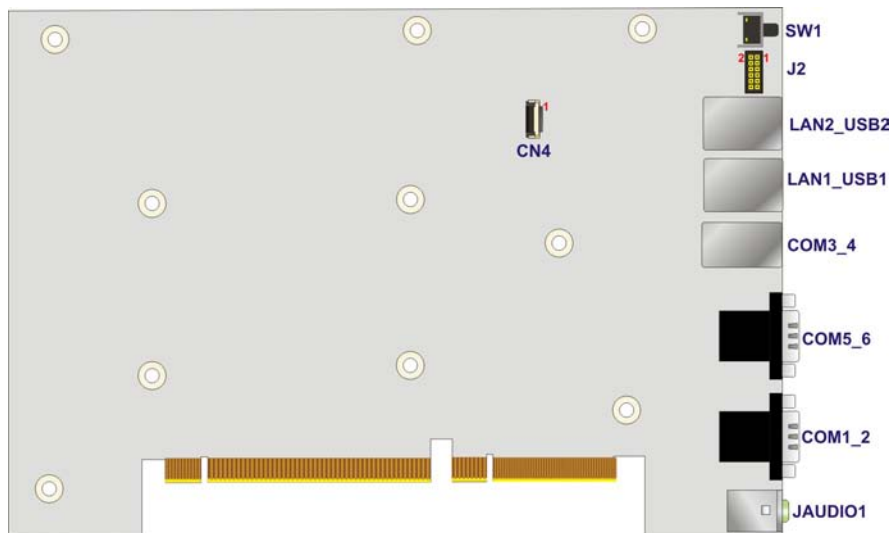

Figure 4-2: System Motherboard (Rear)

4.2 Internal Peripheral Connectors

The table below shows a list of the internal peripheral interface connectors on the system motherboard. Pinouts of these connectors can be found in the following sections.

Connector	Type	Label
Backplane power connector	4-pin wafer	JP1
Battery connector	2-pin wafer	BAT1
BIOS programming connector	6-pin wafer	JSPI1
CPU fan connector	4-pin wafer	CPU_FAN1
DDR4 SO-DIMM slots	DDR4 SO-DIMM slot	DIMM1, DIMM2
DisplayPort connector	20-pin box header	DP1
EC debug connector	20-pin FPC connector	CN4
EC programming connector	6-pin wafer	JSPI2
iRIS-2400 module slot	iRIS-2400 module slot	IPMI1
Keyboard and mouse connector	6-pin wafer	KB_MS1
LED connector	12-pin header	J2
PCIe mini Card	Full size	MPCIE1
PCIe mini Card	Half size	MPCIE2
SATA 6Gb/s drive connectors	14-pin SATA connector	S_ATA1
SATA power connectors	2-pin wafer	CN2, CN3
TPM connector	20-pin header	TPM1
USB 3.0 connectors	19-pin box header	USB3-1

Table 4-1: Peripheral Interface Connectors

4.2.1 Backplane Power Connector (JP1)

PIN NO.	DESCRIPTION	PIN NO.	DESCRIPTION
1	GND	2	GND
3	+12V	4	+5V

Table 4-2: Backplane Power Connector Pinouts (JP1)

4.2.2 Battery Connector (BAT1)

PIN NO.	DESCRIPTION
1	VBATT
2	GND

Table 4-3: Battery Connector Pinouts (BAT1)

4.2.3 BIOS Programming Connector (JSPI1)

PIN NO.	DESCRIPTION	PIN NO.	DESCRIPTION
1	+V3.3M_SPI_CON	2	SPI_CS
3	SPI_SO_SW	4	SPI_CLK_SW
5	SPI_SI_SW	6	GND

Table 4-4: BIOS Programming Connector Pinouts (JSPI1)

4.2.4 CPU Fan Connector (CPU_FAN1)

PIN NO.	DESCRIPTION	PIN NO.	DESCRIPTION
1	GND	2	+V12S
3	FANIO	4	FANOUT

Table 4-5: CPU Fan Connector Pinouts (CPU_FAN1)

4.2.5 DisplayPort Connector (DP1)

PIN NO.	DESCRIPTION	PIN NO.	DESCRIPTION
1	DDI1_HPD#	2	DPD_AUX_CTRL_P2
3	GND	4	DPD_AUX_CTRL_N2
5	AUX_CTRL_DET_D	6	GND
7	GND	8	DPD_OB_LANE2_P_C
9	DPD_OB_LANE3_P_C	10	DPD_OB_LANE2_N_C
11	DPD_OB_LANE3_N_C	12	GND
13	GND	14	DPD_OB_LANE0_P_C
15	DPD_OB_LANE1_P_C	16	DPD_OB_LANE0_N_C

17	DPD_OB_LANE1_N_C	18	VCC3
19	GND	20	NC

Table 4-6: DisplayPort connector Pinouts (DP1)

4.2.6 EC Debug Connector (CN4)

PIN NO.	DESCRIPTION	PIN NO.	DESCRIPTION
1	KSI0	11	KSO9
2	KSO0	12	KSO10
3	KSO1	13	KSO12
4	KSO2	14	KSI1
5	KSO3	15	KSO11
6	KSO4	16	KSI2
7	KSO5	17	KSI3
8	KSO6	18	GND
9	KSO7	19	GND
10	KSO8	20	GND

Table 4-7: EC Debug Connector Pinouts (CN4)

4.2.7 EC Programming Connector (JSPI2)

PIN NO.	DESCRIPTION	PIN NO.	DESCRIPTION
1	+V3.3M_SPI_CON_EC	2	SPI_CS#0_CN_EC
3	SPI_SO_SW_EC	4	SPI_CLK_SW_EC
5	SPI_SI_SW_EC	6	GND

Table 4-8: EC Programming Connector Pinouts (JSPI2)

4.2.8 Keyboard and mouse connector (KB_MS1)

PIN NO.	DESCRIPTION	PIN NO.	DESCRIPTION
1	VCC5_KBMS	2	MSDATA
3	MSCLK	4	KBDATA
5	KBCLOCK	6	KBGND

Table 4-9: Keyboard and mouse connector Pinouts (KB_MS1)

4.2.9 LED Connector (J2)

PIN NO.	DESCRIPTION	PIN NO.	DESCRIPTION
1	+V3.3S_IO	2	+V3.3A_EC_IO
3	IRST_PD#	4	IATX_LED#
5	IPWRLED01#	6	IPWRLED02#
7	IIPMI_LED#	8	ICPU_LED#
9	IDISKLED#	10	N/A
11	GND	12	GND

Table 4-10: LED Connector Pinouts (J2)

4.2.10 SATA Power Connectors (CN2, CN3)

PIN NO.	DESCRIPTION
1	+V5S
2	GND

Table 4-11: SATA Power Connectors Pinouts (CN2, CN3)

4.2.11 TPM Connector (TPM1)

PIN NO.	DESCRIPTION	PIN NO.	DESCRIPTION
1	CLK	2	GND
3	LPC_FRAME#	4	NC
5	PLT_GATED_RST#	6	VCC5
7	LPC_AD3	8	LPC_AD2
9	VCC3	10	LPC_AD1
11	LPC_AD0	12	GND
13	SMB_CLK	14	SMB_DATA
15	V3P3A	16	INT_SERIRQ
17	GND	18	PM_CLKRUN#
19	LPCPD_N	20	TPM_DRQ#0

Table 4-12: TPM Connector Pinouts (TPM1)

4.2.12 USB 3.0 connectors (USB3-1)

PIN NO.	DESCRIPTION	PIN NO.	DESCRIPTION
1	VCC_USB3_56	2	USB3_RX5_N_C
3	USB3_RX5_P_C	4	GND
5	USB3P1_TXDN5_C	6	USB3P1_TXDP5_C
7	GND	8	USB2P5_DM1_L
9	USB2P5_DP1_L	10	NC
11	USB2P6_DP2_L	12	USB2P6_DM2_L
13	GND	14	USB3P1_TXDP6_C
15	USB3P1_TXDN6_C	16	GND
17	USB3_RX6_P_C	18	USB3_RX6_N_C
19	VCC_USB3_56		

Table 4-13: USB 3.0 connectors Pinouts (USB3-1)

4.3 External Interface Panel Connectors

The table below shows a list of the external interface panel connectors on the system motherboard. Pinouts of these connectors can be found in the following sections.

Connector	Type	Label
Audio jack (mic, line-out)	Audio jack	JAUDIO1
DIO connector	DB-9	DIO1
Ethernet and USB3.0 connectors	RJ-45, USB 3.0 port	LAN1_USB1, LAN2_USB2
Power connector	4-pin DC jack	PWR1
Power connector	3-pin terminal block	PWR2
RS-232 serial port connectors	DB-9 w/isolation	COM1_2
RS-232 serial port connectors	Dual RJ-45	COM3_4
RS-232/422/485 serial port connectors	DB-9	COM5_6
USB 2.0 connectors	USB 2.0 port	USB1, USB2
VGA connector	DB-15	VGA1

Table 4-14: Rear Panel Connectors

4.3.1 Audio Jack (J AUDIO1)

PIN NO.	DESCRIPTION	PIN NO.	DESCRIPTION
1	GND	2	ILMIC1-CONN-L
3	GND	4	IJD_MIC
5	ILMIC1-CONN-R	22	ILFRONT-L
23	GND	24	IJD_FRONT
25	ILFRONT-R		

Table 4-15: Audio Jack Pinouts (JAUDIO1)

4.3.2 DIO connector (DIO1)

PIN NO.	DESCRIPTION	PIN NO.	DESCRIPTION
1	DIN0	2	DOUT0
3	DIN1	4	DOUT1
5	DIN2	6	DOUT2
7	DIN3	8	DOUT3
9	+5V		

Table 4-16: DIO connector Pinouts (DIO1)

4.3.3 Ethernet and USB3.0 Connectors (LAN1_USB1)

PIN	DESCRIPTION	PIN	DESCRIPTION
U1	USBV0L	U10	USBV0L
U2	DATA0_N	U11	DATA1_N
U3	DATA0_P	U12	DATA1_P
U4	GND	U13	GND
U5	IUSB3_RX1_N	U14	IUSB3_RX2_N
U6	IUSB3_RX1_P	U15	IUSB3_RX2_P
U7	GND	U16	GND
U8	IUSB3_TX1_N	U17	IUSB3_TX2_N
U9	IUSB3_TX1_P	U18	IUSB3_TX2_P

Table 4-17: USB 3.0 Port Pinouts (USB1)

PIN	DESCRIPTION	PIN	DESCRIPTION
R1	GND	R2	ILAN_MDI0_DP
R3	ILAN_MDI0_DN	R4	ILAN_MDI1_DP
R5	ILAN_MDI1_DN	R6	ILAN_MDI2_DP
R7	ILAN_MDI2_DN	R8	ILAN_MDI3_DP
R9	ILAN_MDI3_DN	R10	GND
L1	ILAN1_1000-	L2	ILAN1_100-
L3	ILAN1_LINK_ACT-	L4	ILAN1_LINK_PWR

Table 4-18: LAN Pinouts (LAN1)

4.3.4 Ethernet and USB3.0 Connectors (LAN2_USB2)

PIN	DESCRIPTION	PIN	DESCRIPTION
U1	USBV2L	U10	USBV2L
U2	DATA3_N	U11	DATA2_N
U3	DATA3_P	U12	DATA2_P
U4	GND	U13	GND
U5	IUSB3_RX4_N	U14	IUSB3_RX3_N
U6	IUSB3_RX4_P	U15	IUSB3_RX3_P
U7	GND	U16	GND
U8	IUSB3_TX4_N	U17	IUSB3_TX3_N
U9	IUSB3_TX4_P	U18	IUSB3_TX3_P

Table 4-19: USB 3.0 Port Pinouts (USB2)

PIN	DESCRIPTION	PIN	DESCRIPTION
R1	GND	R2	ITRD2P0
R3	ITRD2N0	R4	ITRD2P1
R5	ITRD2N1	R6	ITRD2P2
R7	ITRD2N2	R8	ITRD2P3
R9	ITRD2N3	R10	GND
L1	ILANEXT_1000-	L2	ILANEXT_100-
L3	ILANEXT_LINK_ACT-	L4	ILANEXT_LINK_PWR

Table 4-20: LAN Pinouts (LAN2)

4.3.5 Power Connector (PWR1)

PIN NO.	DESCRIPTION	PIN NO.	DESCRIPTION
1	VIN1	2	GND
3	VIN1	4	GND
5	GND		

Table 4-21: Power Connector Pinouts (PWR2)

4.3.6 Power Connector (PWR2)

PIN NO.	DESCRIPTION	PIN NO.	DESCRIPTION
1	ACCON	2	+VIN
3	GND		

Table 4-22: Power Connector Pinouts (PWR1)

4.3.7 RS-232 Serial Port Connector (COM1_2)

PIN NO.	DESCRIPTION	PIN NO.	DESCRIPTION
1(10)	DCD	6(15)	DSR
2(11)	RX	7(16)	RTS
3(12)	TX	8(17)	CTS
4(13)	DTR	9(18)	RI
5(14)	GND		

Table 4-23: RS-232 Serial Port Connector Pinouts (COM1_2)

4.3.8 RS-232 Serial Port Connectors (COM3_4)

PIN NO.	DESCRIPTION	PIN NO.	DESCRIPTION
1	DCD	5	RTS
2	DTR	6	RX
3	DSR	7	DSR
4	TX	8	DCD

Table 4-24: RS-232 Serial Port Connectors Pinouts (COM3_4)

4.3.9 RS-232/422/485 Serial Port Connector (COM5_6)

PIN NO.	RS-232	RS-422	RS-485
1(10)	DCD	TXD422#	TXD485#
2(11)	RX	TXD422+	TXD485+
3(12)	TX	RXD422+	--
4(13)	DTR	RXD422#	--
5(14)	GND	--	--
6(15)	DSR	--	--
7(16)	RTS	--	--
8(17)	CTS	--	--
9(18)	RI	--	--

Table 4-25: RS-232/422/485 Serial Port Connector Pinout (COM5_6)

4.3.10 USB 2.0 Connectors (USB1)

PIN NO.	DESCRIPTION	PIN NO.	DESCRIPTION
1	VCC_USB78	2	-DATA7
3	+DATA7	4	GND
5	VCC_USB78	6	-DATA8
7	+DATA8	8	GND

Table 4-26: USB 2.0 Connectors Pinouts (USB1)

4.3.11 USB 2.0 Connectors (USB2)

PIN NO.	DESCRIPTION	PIN NO.	DESCRIPTION
1	VCC_USB910	2	-DATA9
3	+DATA9	4	GND
5	VCC_USB910	6	-DATA10
7	+DATA10	8	GND

Table 4-27: USB 2.0 Connectors Pinouts (USB2)

4.3.12 VGA Connector (VGA1)

PIN NO.	DESCRIPTION	PIN NO.	DESCRIPTION
---------	-------------	---------	-------------

TANK-870-Q170 Embedded System

1	Red	2	Green
3	Blue	4	NC
5	GND	6	GND
7	GND	8	GND
9	VGAVCC	10	HOTPLUG
11	NC	12	DDCDAT
13	HSYNC	14	VSYNC
15	DDCCLK		

Table 4-28: VGA Connector Pinouts (VGA1)

Chapter

5

BIOS

5.1 Introduction

The BIOS is programmed onto the BIOS chip. The BIOS setup program allows changes to certain system settings. This chapter outlines the options that can be changed.



NOTE:

Some of the BIOS options may vary throughout the life cycle of the product and are subject to change without prior notice.

5.1.1 Starting Setup

The UEFI BIOS is activated when the computer is turned on. The setup program can be activated in one of two ways.

1. Press the **DEL** or **F2** key as soon as the system is turned on or
2. Press the **DEL** or **F2** key when the “**Press DEL or F2 to enter SETUP**” message appears on the screen.

If the message disappears before the **DEL** or **F2** key is pressed, restart the computer and try again.

5.1.2 Using Setup

Use the arrow keys to highlight items, press **ENTER** to select, use the PageUp and PageDown keys to change entries, press **F1** for help and press **ESC** to quit. Navigation keys are shown in.

Key	Function
Up arrow	Move to previous item
Down arrow	Move to next item
Left arrow	Move to the item on the left hand side
Right arrow	Move to the item on the right hand side
+	Increase the numeric value or make changes

Key	Function
-	Decrease the numeric value or make changes
Page Up key	Increase the numeric value or make changes
Page Dn key	Decrease the numeric value or make changes
Esc key	Main Menu – Quit and not save changes into CMOS Status Page Setup Menu and Option Page Setup Menu -- Exit current page and return to Main Menu
F1	General help, only for Status Page Setup Menu and Option Page Setup Menu
F2	Previous values
F3	Load optimized defaults
F4	Save changes and Exit BIOS

Table 5-1: BIOS Navigation Keys

5.1.3 Getting Help

When **F1** is pressed a small help window describing the appropriate keys to use and the possible selections for the highlighted item appears. To exit the Help Window press **Esc** or the **F1** key again.

5.1.4 Unable to Reboot after Configuration Changes

If the computer cannot boot after changes to the system configuration is made, CMOS defaults. Use the jumper described in Chapter 2.

5.1.5 BIOS Menu Bar

The **menu bar** on top of the BIOS screen has the following main items:

- Main – Changes the basic system configuration.
- Advanced – Changes the advanced system settings.
- Chipset – Changes the chipset settings.
- Boot – Changes the system boot configuration.
- Security – Sets User and Supervisor Passwords.

TANK-870-Q170 Embedded System

- Save & Exit – Selects exit options and loads default settings.

The following sections completely describe the configuration options found in the menu items at the top of the BIOS screen and listed above.

5.2 Main

The **Main** BIOS menu (**BIOS Menu 1**) appears when the **BIOS Setup** program is entered.

The **Main** menu gives an overview of the basic system information.

Aptio Setup Utility - Copyright (C) 2016 American Megatrends, Inc.			
Main	Advanced	Chipset Security Boot Save & Exit Server Mgmt	
BIOS Information			
BIOS Vendor	American Megatrends	Set the Date. Use Tab to switch between Data elements.	
Core Version	5.11		
Compliancy	UEFI 2.4; PI 1.3		
Project Version	SER0AR10.bin		
Build Date	07/25/2016 13:59:45		
Access Level	Administrator		
iWDD Vendor	iEi		
iWDD Version	SER0ER10.bin		
IPMI Card Status	Not Present		
IEI QTS Status	[Non-Activated(IPC)]		
Processor Information			
Name	SkyLake DT	----- ←→: Select Screen ↑↓: Select Item Enter>Select +/-: Change Opt. F1: General Help F2: Previous Values F3: Optimized Defaults F4: Save & Exit ESC: Exit	
Brand String	Intel(R) Core(TM) i7-6700E CPU @ 2.40GHz		
Frequency	2400 MHz		
Processor ID	506E3		
Stepping	R0/S0/N0		
Number of Processors	4Core(s) / 8Thread(s)		
Microcode Revision	9E		
GT Info	GT2		
IGFX VBIOS Version	1040		
Memory RC Version	1.8.0.1		
Total Memory	4096 MB		
Memory Frequency	2133 MHz		
PCH Information			
Name	SKL PCH-H		
PCH SKU	PCH-H Desktop Q170 SKU		
Stepping	31/D1		
LAN PHY Revision	B2		
ME FW Version	11.0.16.1000		
ME Firmware SKU	Corporate SKU		
SPI Clock Frequency			
DOFR Support	Unsupported		
Read Status Clock Frequency	17 MHz		
Write Status Clock Frequency	48 MHz		
Fast Read Status Clock Frequency	48 MHz		
System Date	[Mon 11/28/2016]		
System Time	[15:43:27]		

Version 2.17.1255. Copyright (C) 2016 American Megatrends, Inc.

BIOS Menu 1: Main

TANK-870-Q170 Embedded System

The Main menu has two user configurable fields:

→ System Date [xx/xx/xx]

Use the **System Date** option to set the system date. Manually enter the day, month and year.

→ System Time [xx:xx:xx]

Use the **System Time** option to set the system time. Manually enter the hours, minutes and seconds.

5.3 Advanced

Use the **Advanced** menu (**BIOS Menu 2**) to configure the CPU and peripheral devices through the following sub-menus:



WARNING!

Setting the wrong values in the sections below may cause the system to malfunction. Make sure that the settings made are compatible with the hardware.

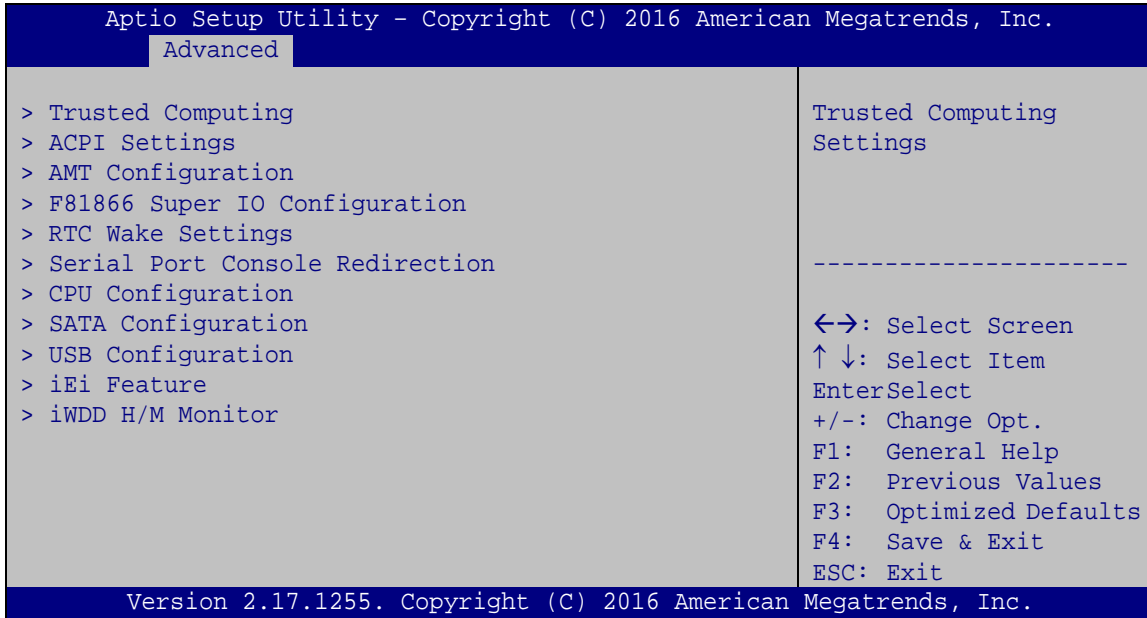

BIOS Menu 2: Advanced

5.3.1 Trusted Computing

Use the **Trusted Computing** menu (**BIOS Menu 3**) to configure settings related to the Trusted Computing Group (TCG) Trusted Platform Module (TPM).

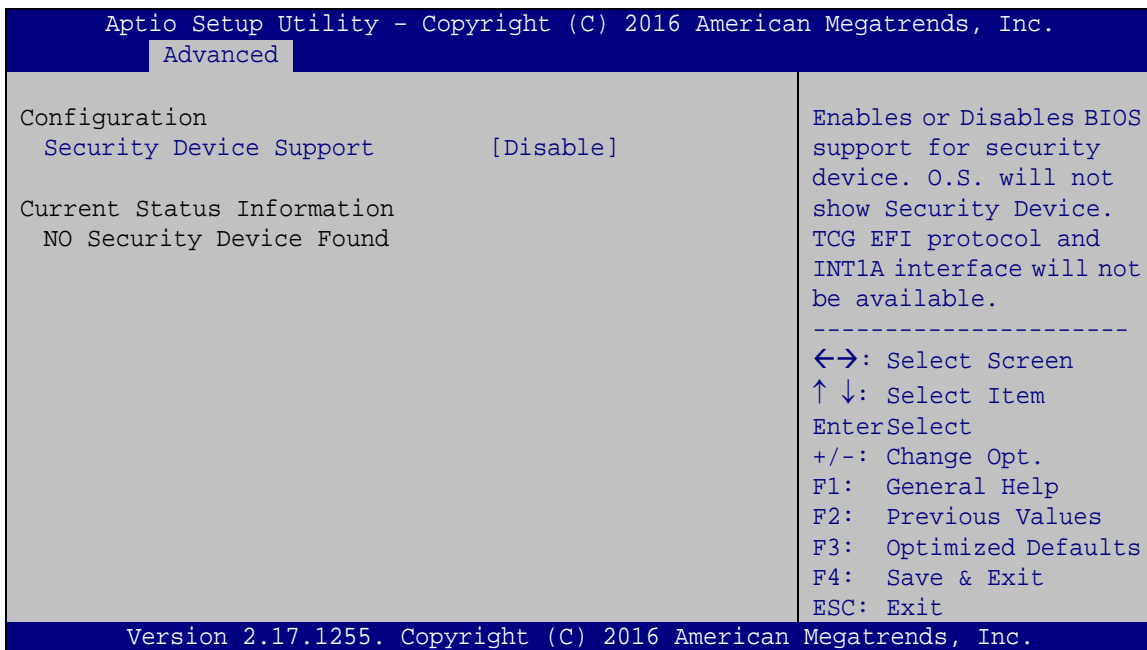

BIOS Menu 3: Trusted Computing

TANK-870-Q170 Embedded System

➔ Security Device Support [Disable]

Use the **Security Device Support** option to configure support for the security device.

➔ **Disable** **DEFAULT** Security device support is disabled.

➔ **Enable** Security device support is enabled.

5.3.2 ACPI Settings

The **ACPI Settings** menu (**BIOS Menu 4**) configures the Advanced Configuration and Power Interface (ACPI) options.

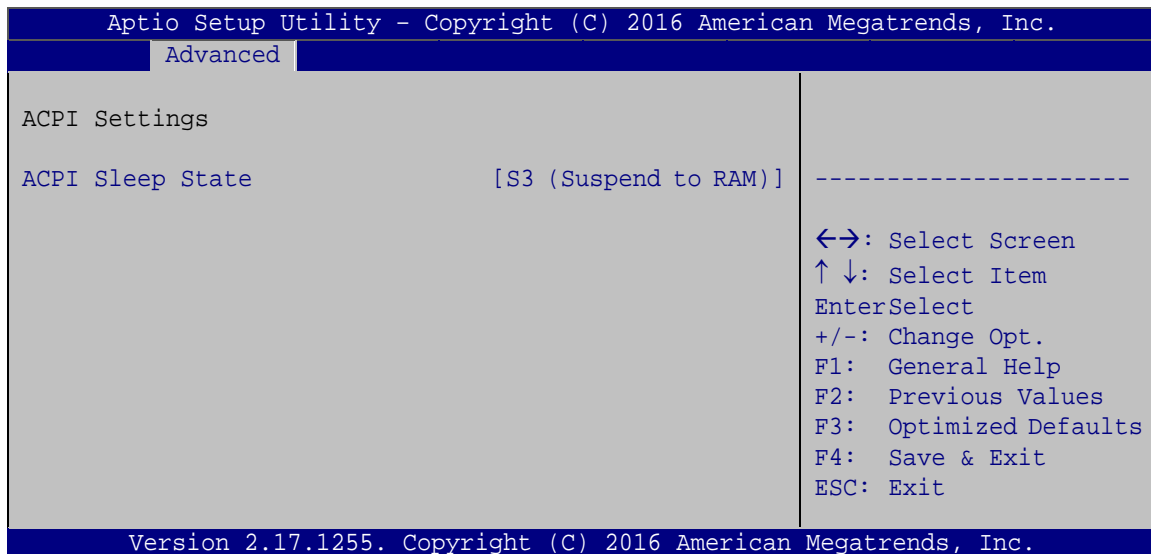

BIOS Menu 4: ACPI Configuration

➔ ACPI Sleep State [S3 (Suspend to RAM)]

Use the **ACPI Sleep State** option to specify the sleep state the system enters when it is not being used.

➔ **S3 (Suspend to RAM)**

The caches are flushed and the CPU is powered off. Power to the RAM is maintained. The computer returns slower to a working state, but more power is saved.

5.3.3 AMT Configuration

The **AMT Configuration** menu (**BIOS Menu 5**) allows the advanced power management options to be configured.

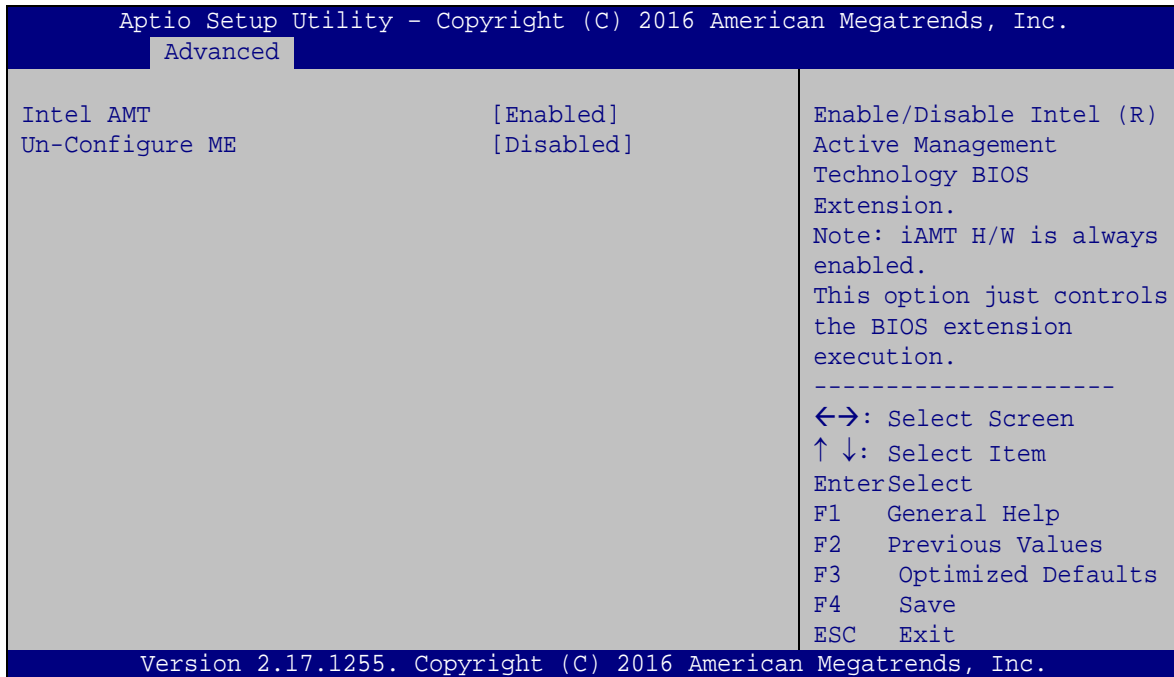

BIOS Menu 5: AMT Configuration

➔ Intel AMT [Enabled]

Use **Intel AMT** option to enable or disable the Intel® AMT function.

➔ **Disabled** Intel® AMT is disabled

➔ **Enabled** **DEFAULT** Intel® AMT is enabled

➔ Un-Configure ME [Disabled]

Use the **Un-Configure ME** option to perform ME unconfigure without password operation.

➔ **Disabled** **DEFAULT** Not perform ME unconfigure

➔ **Enabled** To perform ME unconfigure

TANK-870-Q170 Embedded System

5.3.4 F81866 Super IO Configuration

Use the **F81866 Super IO Configuration** menu (**BIOS Menu 6**) to set or change the configurations for the serial ports.

```

Aptio Setup Utility - Copyright (C) 2016 American Megatrends, Inc.
  Advanced
F81866 Super IO Configuration          Set Parameters of Serial
F81866 Super IO Chip                  Port 1 (COMA)
                                     F81866
> Serial Port 1 Configuration
> Serial Port 2 Configuration
> Serial Port 3 Configuration
> Serial Port 4 Configuration
> Serial Port 5 Configuration
> Serial Port 6 Configuration
                                     -----
                                     <->: Select Screen
                                     ↑ ↓: Select Item
                                     EnterSelect
                                     +/-: Change Opt.
                                     F1:  General Help
                                     F2:  Previous Values
                                     F3:  Optimized Defaults
                                     F4:  Save & Exit
                                     ESC: Exit
Version 2.17.1255. Copyright (C) 2016 American Megatrends, Inc.

```

BIOS Menu 6: F81866 Super IO Configuration

5.3.4.1 Serial Port n Configuration

Use the **Serial Port n Configuration** menu (**BIOS Menu 7**) to configure the serial port n.

```

Aptio Setup Utility - Copyright (C) 2016 American Megatrends, Inc.
  Advanced
Serial Port n Configuration          Enable or Disable Serial
Serial Port                          Port (COM)
Device Settings                       [Enabled]
                                     IO=3F8h; IRQ=4
Change Settings                       [Auto]
                                     -----
                                     <->: Select Screen
                                     ↑ ↓: Select Item
                                     EnterSelect
                                     +/-: Change Opt.
                                     F1:  General Help
                                     F2:  Previous Values
                                     F3:  Optimized Defaults
                                     F4:  Save & Exit
                                     ESC: Exit
Version 2.17.1255. Copyright (C) 2016 American Megatrends, Inc.

```

BIOS Menu 7: Serial Port n Configuration Menu

5.3.4.1.1 Serial Port 1 Configuration

→ Serial Port [Enabled]

Use the **Serial Port** option to enable or disable the serial port.

- **Disabled** Disable the serial port
- **Enabled** **DEFAULT** Enable the serial port

→ Change Settings [Auto]

Use the **Change Settings** option to change the serial port IO port address and interrupt address.

- **Auto** **DEFAULT** The serial port IO port address and interrupt address are automatically detected.
- **IO=3F8h; IRQ=4** Serial Port I/O port address is 3F8h and the interrupt address is IRQ4
- **IO=3F8h; IRQ=3, 4, 7, 9, 10, 11** Serial Port I/O port address is 3F8h and the interrupt address is IRQ3, 4, 7, 9, 10, 11
- **IO=2F8h; IRQ=3, 4, 7, 9, 10, 11** Serial Port I/O port address is 2F8h and the interrupt address is IRQ3, 4, 7, 9, 10, 11
- **IO=3E8h; IRQ=3, 4, 7, 9, 10, 11** Serial Port I/O port address is 3E8h and the interrupt address is IRQ3, 4, 7, 9, 10, 11
- **IO=2E8h; IRQ=3, 4, 7, 9, 10, 11** Serial Port I/O port address is 2E8h and the interrupt address is IRQ3, 4, 7, 9, 10, 11

5.3.4.1.2 Serial Port 2 Configuration

→ Serial Port [Enabled]

Use the **Serial Port** option to enable or disable the serial port.

- **Disabled** Disable the serial port

TANK-870-Q170 Embedded System

➔ **Enabled** **DEFAULT** Enable the serial port

➔ Change Settings [Auto]

Use the **Change Settings** option to change the serial port IO port address and interrupt address.

- | | | | |
|---|--|----------------|---|
| ➔ | Auto | DEFAULT | The serial port IO port address and interrupt address are automatically detected. |
| ➔ | IO=2F8h; IRQ=3 | | Serial Port I/O port address is 2F8h and the interrupt address is IRQ3 |
| ➔ | IO=3F8h; IRQ=3,
4, 7, 9, 10, 11 | | Serial Port I/O port address is 3F8h and the interrupt address is IRQ3, 4, 7, 9, 10, 11 |
| ➔ | IO=2F8h; IRQ=3,
4, 7, 9, 10, 11 | | Serial Port I/O port address is 2F8h and the interrupt address is IRQ3, 4, 7, 9, 10, 11 |
| ➔ | IO=3E8h; IRQ=3,
4, 7, 9, 10, 11 | | Serial Port I/O port address is 3E8h and the interrupt address is IRQ3, 4, 7, 9, 10, 11 |
| ➔ | IO=2E8h; IRQ=3,
4, 7, 9, 10, 11 | | Serial Port I/O port address is 2E8h and the interrupt address is IRQ3, 4, 7, 9, 10, 11 |

5.3.4.1.3 Serial Port 3 Configuration

➔ Serial Port [Enabled]

Use the **Serial Port** option to enable or disable the serial port.

➔ **Disabled** Disable the serial port

➔ **Enabled** **DEFAULT** Enable the serial port

➔ Change Settings [Auto]

Use the **Change Settings** option to change the serial port IO port address and interrupt address.

➔	Auto	DEFAULT	The serial port IO port address and interrupt address are automatically detected.
➔	IO=3E8h; IRQ=10		Serial Port I/O port address is 3E8h and the interrupt address is IRQ10
➔	IO=3E8h; IRQ=3, 4, 7, 9, 10, 11		Serial Port I/O port address is 3E8h and the interrupt address is IRQ3, 4, 7, 9, 10, 11
➔	IO=2E8h; IRQ=3, 4, 7, 9, 10, 11		Serial Port I/O port address is 2E8h and the interrupt address is IRQ3, 4, 7, 9, 10, 11
➔	IO=3E0h; IRQ=3, 4, 7, 9, 10, 11		Serial Port I/O port address is 3E0h and the interrupt address is IRQ3, 4, 7, 9, 10, 11
➔	IO=2E0h; IRQ=3, 4, 7, 9, 10, 11		Serial Port I/O port address is 2E0h and the interrupt address is IRQ3, 4, 7, 9, 10, 11

5.3.4.1.4 Serial Port 4 Configuration

➔ Serial Port [Enabled]

Use the **Serial Port** option to enable or disable the serial port.

➔	Disabled		Disable the serial port
➔	Enabled	DEFAULT	Enable the serial port

➔ Change Settings [Auto]

Use the **Change Settings** option to change the serial port IO port address and interrupt address.

➔	Auto	DEFAULT	The serial port IO port address and interrupt address are automatically detected.
➔	IO=2E8h; IRQ=10		Serial Port I/O port address is 2E8h and the interrupt address is IRQ10
➔	IO=3E8h; IRQ=3, 4, 7, 9, 10, 11		Serial Port I/O port address is 3E8h and the interrupt address is IRQ3, 4, 7, 9, 10, 11

TANK-870-Q170 Embedded System

- | | |
|--|--|
| <ul style="list-style-type: none"> ➔ IO=2E8h; IRQ=3, 4, 7, 9, 10, 11 ➔ IO=3E0h; IRQ=3, 4, 7, 9, 10, 11 ➔ IO=2E0h; IRQ=3, 4, 7, 9, 10, 11 | <p>Serial Port I/O port address is 2E8h and the interrupt address is IRQ3, 4, 7, 9, 10, 11</p> <p>Serial Port I/O port address is 3E0h and the interrupt address is IRQ3, 4, 7, 9, 10, 11</p> <p>Serial Port I/O port address is 2E0h and the interrupt address is IRQ3, 4, 7, 9, 10, 11</p> |
|--|--|

5.3.4.1.5 Serial Port 5 Configuration

➔ Serial Port [Enabled]

Use the **Serial Port** option to enable or disable the serial port.

- | | |
|---|--|
| <ul style="list-style-type: none"> ➔ Disabled ➔ Enabled DEFAULT | <p>Disable the serial port</p> <p>Enable the serial port</p> |
|---|--|

➔ Change Settings [Auto]

Use the **Change Settings** option to change the serial port IO port address and interrupt address.

- | | |
|---|---|
| <ul style="list-style-type: none"> ➔ Auto DEFAULT ➔ IO=3E0h; IRQ=10 ➔ IO=3E8h; IRQ=3, 4, 7, 9, 10, 11 ➔ IO=2E8h; IRQ=3, 4, 7, 9, 10, 11 ➔ IO=3E0h; IRQ=3, 4, 7, 9, 10, 11 ➔ IO=2E0h; IRQ=3, 4, 7, 9, 10, 11 | <p>The serial port IO port address and interrupt address are automatically detected.</p> <p>Serial Port I/O port address is 3E0h and the interrupt address is IRQ10</p> <p>Serial Port I/O port address is 3E8h and the interrupt address is IRQ3, 4, 7, 9, 10, 11</p> <p>Serial Port I/O port address is 2E8h and the interrupt address is IRQ3, 4, 7, 9, 10, 11</p> <p>Serial Port I/O port address is 3E0h and the interrupt address is IRQ3, 4, 7, 9, 10, 11</p> <p>Serial Port I/O port address is 2E0h and the interrupt address is IRQ3, 4, 7, 9, 10, 11</p> |
|---|---|

→ Device Mode [RS232]

Use the **Device Mode** option to select the serial port mode.

- **RS232** **DEFAULT** Enables serial port RS-232 support.
- **RS422** Enables serial port RS-422 support.
- **RS485** Enables serial port RS-485 support.

5.3.4.1.6 Serial Port 6 Configuration

→ Serial Port [Enabled]

Use the **Serial Port** option to enable or disable the serial port.

- **Disabled** Disable the serial port
- **Enabled** **DEFAULT** Enable the serial port

→ Change Settings [Auto]

Use the **Change Settings** option to change the serial port IO port address and interrupt address.

- **Auto** **DEFAULT** The serial port IO port address and interrupt address are automatically detected.
- **IO=2E0h; IRQ=10** Serial Port I/O port address is 2E0h and the interrupt address is IRQ10
- **IO=3E8h; IRQ=3, 4, 7, 9, 10, 11** Serial Port I/O port address is 3E8h and the interrupt address is IRQ3, 4, 7, 9, 10, 11
- **IO=2E8h; IRQ=3, 4, 7, 9, 10, 11** Serial Port I/O port address is 2E8h and the interrupt address is IRQ3, 4, 7, 9, 10, 11
- **IO=3E0h; IRQ=3, 4, 7, 9, 10, 11** Serial Port I/O port address is 3E0h and the interrupt address is IRQ3, 4, 7, 9, 10, 11
- **IO=2E0h; IRQ=3, 4, 7, 9, 10, 11** Serial Port I/O port address is 2E0h and the interrupt address is IRQ3, 4, 7, 9, 10, 11

TANK-870-Q170 Embedded System

→ Device Mode [RS232]

Use the **Device Mode** option to select the serial port mode.

- **RS232** **DEFAULT** Enables serial port RS-232 support.
- **RS422** Enables serial port RS-422 support.
- **RS485** Enables serial port RS-485 support.

5.3.5 RTC Wake Settings

The **RTC Wake Settings** menu (**BIOS Menu 8**) configures RTC wake event.

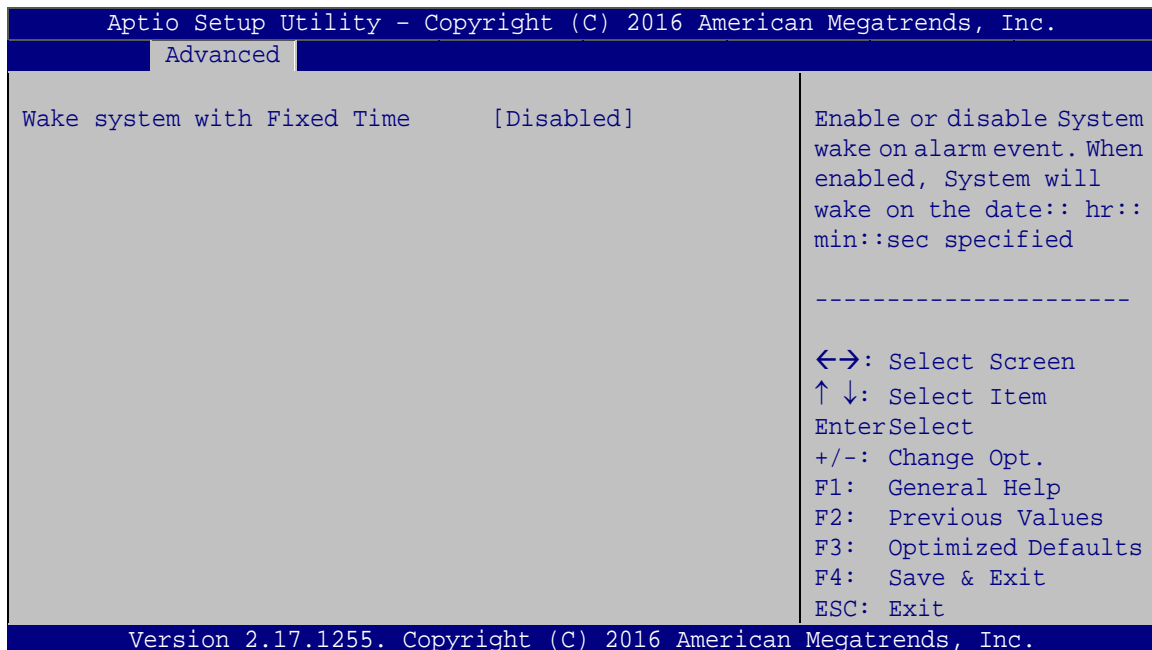

BIOS Menu 8: RTC Wake Settings

→ Wake System with Fixed Time [Disabled]

Use the **Wake System with Fixed Time** option to specify the time the system should be roused from a suspended state.

- **Disabled** **DEFAULT** The real time clock (RTC) cannot generate a wake event

→ Enabled

If selected, the following appears with values that can be selected:

*Wake up every day

*Wake up date

*Wake up hour

*Wake up minute

*Wake up second

After setting the alarm, the computer turns itself on from a suspend state when the alarm goes off.

5.3.6 Serial Port Console Redirection

The **Serial Port Console Redirection** menu (**BIOS Menu 9**) allows the console redirection options to be configured. Console redirection allows users to maintain a system remotely by re-directing keyboard input and text output through the serial port.

TANK-870-Q170 Embedded System

```

Aptio Setup Utility - Copyright (C) 2016 American Megatrends, Inc.
  Advanced
COM1
  Console Redirection          [Disabled]          Console Redirection
  > Console Redirection Settings          Enable or Disable

COM2
  Console Redirection          [Disabled]
  > Console Redirection Settings

COM3
  Console Redirection          [Disabled]
  > Console Redirection Settings

COM4
  Console Redirection          [Disabled]
  > Console Redirection Settings

COM5
  Console Redirection          [Disabled]
  > Console Redirection Settings

COM6
  Console Redirection          [Disabled]
  > Console Redirection Settings

IPMI SOL (Disabled)
  Console Redirection          Port Is Disabled

iAMT SOL

COM8(Pci Bus0, Dev0, Func0)(Disabled)
  Console Redirection          Port Is Disabled

-----
<=>: Select Screen
↑ ↓: Select Item
Enter>Select
+/-: Change Opt.
F1: General Help
F2: Previous Values
F3: Optimized Defaults
F4: Save & Exit
ESC: Exit

Version 2.17.1255. Copyright (C) 2016 American Megatrends, Inc.
  
```

BIOS Menu 9: Serial Port Console Redirection

➔ Console Redirection [Disabled]

Use **Console Redirection** option to enable or disable the console redirection function.

- ➔ **Disabled** **DEFAULT** Disabled the console redirection function
- ➔ **Enabled** Enabled the console redirection function

5.3.6.1 Console Redirection Settings

The **Console Redirection Settings** menu (**BIOS Menu 10**) allows the console redirection options to be configured. The option is active when Console Redirection option is enabled.

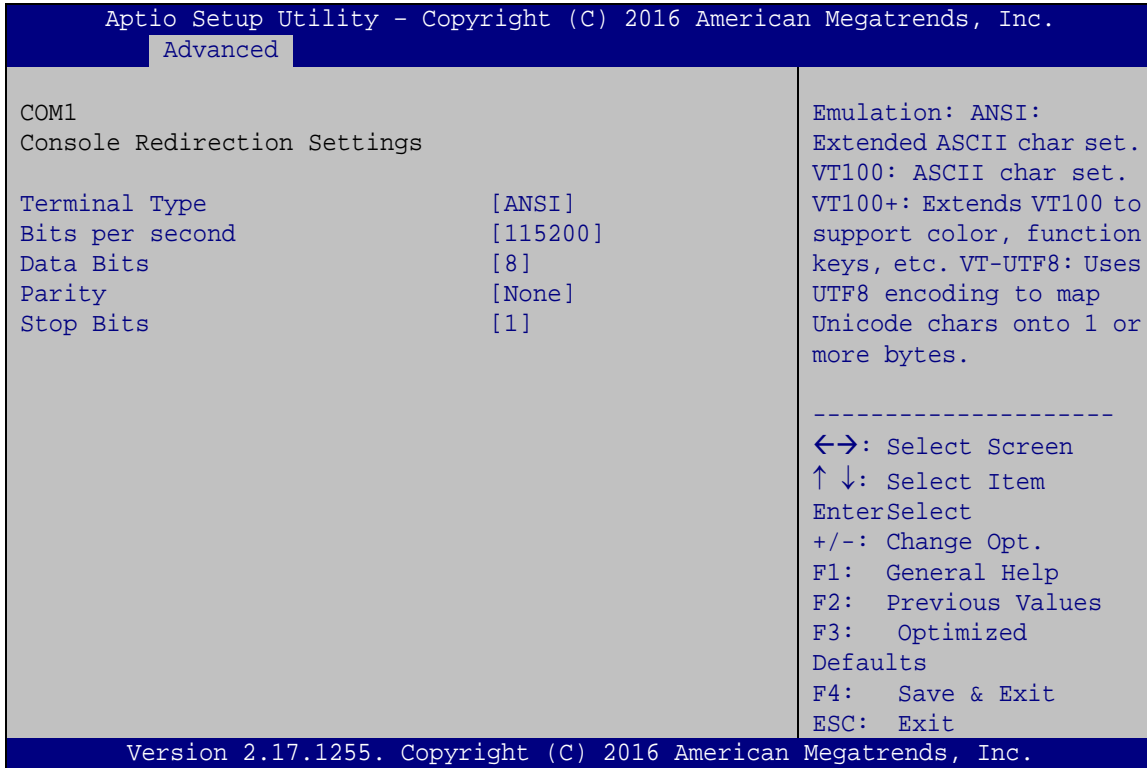

BIOS Menu 10: Console Redirection Settings

➔ Terminal Type [ANSI]

Use the **Terminal Type** option to specify the remote terminal type..

- ➔ **VT100** The target terminal type is VT100
- ➔ **VT100+** The target terminal type is VT100+
- ➔ **VT-UTF8** The target terminal type is VT-UTF8
- ➔ **ANSI** **DEFAULT** The target terminal type is ANSI

➔ Bits per second [115200]

Use the **Bits per second** option to specify the transmission speed of the serial port.

- ➔ **9600** The transmission speed is 9600
- ➔ **19200** The transmission speed is 19200
- ➔ **38400** The transmission speed is 38400

TANK-870-Q170 Embedded System

- **57600** The transmission speed is 57600
- **115200** **DEFAULT** The transmission speed is 115200

→ Data Bits [8]

Use the **Data Bits** option to specify the number of data bits.

- **7** Sets the data bits at 7.
- **8** **DEFAULT** Sets the data bits at 8.

→ Parity [None]

Use the **Parity** option to specify the parity bit that can be sent with the data bits for detecting the transmission errors.

- **None** **DEFAULT** No parity bit is sent with the data bits.
- **Even** The parity bit is 0 if the number of ones in the data bits is even.
- **Odd** The parity bit is 0 if the number of ones in the data bits is odd.
- **Mark** The parity bit is always 1. This option does not provide error detection.
- **Space** The parity bit is always 0. This option does not provide error detection.

→ Stop Bits [1]

Use the **Stop Bits** option to specify the number of stop bits used to indicate the end of a serial data packet. Communication with slow devices may require more than 1 stop bit.

- **1** **DEFAULT** Sets the number of stop bits at 1.
- **2** Sets the number of stop bits at 2.

5.3.7 CPU Configuration

Use the **CPU Configuration** menu (**BIOS Menu 11**) to enter the **CPU Information** submenu or enable Intel Virtualization Technology.

```

Aptio Setup Utility - Copyright (C) 2016 American Megatrends, Inc.
  Advanced
CPU Configuration
Intel(R) Core(TM) i7-6700TE CPU @ 2.40GHz
CPU Signature          506E3
Microcode Patch       9E
Max CPU Speed         2400 MHz
Min CPU Speed         800 MHz
CPU Speed             2400 MHz
Processor Cores       4
Hyper Threading Technology Supported
Intel VT-x Technology Supported
Intel SMX Technology  Supported
64-bit                Supported
EIST Technology       Supported

L1 Data Cache        32 kB x 4
L1 Code Cache        32 kB x 4
L2 Cache             256 kB x 4
L3 Cache             8 MB
L4 Cache             Not Present

Hyper-threading      [Enabled]
Active Processor Cores [All]
Intel Virtualization Technology [Disabled]
EIST                 [Enabled]
CPU C states         [Disabled]
Intel TXT(LT) Support [Disabled]

-----
<->: Select Screen
^ v: Select Item
Enter>Select
+/-: Change Opt.
F1:  General Help
F2:  Previous Values
F3:  Optimized Defaults
F4:  Save & Exit
ESC: Exit

Version 2.17.1255. Copyright (C) 2016 American Megatrends, Inc.
  
```

BIOS Menu 11: CPU Configuration

The CPU Configuration menu (**BIOS Menu 11**) lists the following CPU details:

- Processor Type: Lists the brand name of the CPU being used
- CPU Signature: Lists the CPU signature value.
- Microcode Patch: Lists the microcode patch being used.
- Max CPU Speed: Lists the maximum CPU processing speed.
- Min CPU Speed: Lists the minimum CPU processing speed.
- CPU Speed: Lists the CPU processing speed.

TANK-870-Q170 Embedded System

- Processor Cores: Lists the number of the processor core
- Hyper Threading Technology: Indicates if Intel Hyper Threading Technology is supported by the CPU.
- Intel VT-x Technology: Indicates if Intel VT-x Technology is supported by the CPU.
- Intel SMX Technology: Indicates if Intel SMX Technology is supported by the CPU.
- 64-bit: Indicates if 64-bit is supported by the CPU.
- EIST Technology: Indicates if EIST Technology is supported by the CPU.
- L1 Data Cache: Lists the amount of data storage space on the L1 cache.
- L1 Code Cache: Lists the amount of code storage space on the L1 cache.
- L2 Cache: Lists the amount of storage space on the L2 cache.
- L3 Cache: Lists the amount of storage space on the L3 cache.
- L4 Cache: Lists the amount of storage space on the L4 cache.

→ Hyper-threading [Enabled]

Use the **Hyper-threading** BIOS option to enable or disable the Intel Hyper-Threading Technology.

- **Disabled** Disables the Intel Hyper-Threading Technology.
- **Enabled** **DEFAULT** Enables the Intel Hyper-Threading Technology.

→ Active Processor Cores [All]

Use the **Active Processor Cores** option to configure the number of the active processor cores.

- **All** **DEFAULT** Active all of the processor cores
- **1** Active one of the processor cores
- **2** Active two of the processor cores
- **3** Active three of the processor cores

→ Intel Virtualization Technology [Disabled]

Use the **Intel Virtualization Technology** option to enable or disable virtualization on the system. When combined with third party software, Intel Virtualization technology allows several OSs to run on the same system at the same time.

→ **Disabled** **DEFAULT** Disables Intel Virtualization Technology.

→ **Enabled** Enables Intel Virtualization Technology.

→ EIST [Enabled]

Use the **EIST** option to enable or disable the Intel Speed Step Technology.

→ **Disabled** Disables the Intel Speed Step Technology.

→ **Enabled** **DEFAULT** Enables the Intel Speed Step Technology.

→ CPU C states [Disabled]

Use the **CPU C states** option to enable or disable CPU C states.

→ **Disabled** **DEFAULT** Disables CPU C states.

→ **Enabled** Enables CPU C states.

→ Intel TXT(LT) Support [Disabled]

Use the **Intel TXT(LT) Support** option to enable or disable the Intel® Trusted Execution Technology.

→ **Disabled** **DEFAULT** Disables the Intel® Trusted Execution Technology.

→ **Enabled** Enables the Intel® Trusted Execution Technology.

TANK-870-Q170 Embedded System

5.3.8 SATA Configuration

Use the **SATA Configuration** menu (**BIOS Menu 12**) to change and/or set the configuration of the SATA devices installed in the system.

```

Aptio Setup Utility - Copyright (C) 2016 American Megatrends, Inc.
  Advanced
SATA Controller(s)          [Enabled]          Enable or disable SATA
SATA Mode Selection        [AHCI]           Device.
S_ATA1(Down)              Empty
S_ATA1(Up)                Empty
mSATA(MPCIEx1)            Empty
-----
<->: Select Screen
^ v: Select Item
Enter: Select
+/-: Change Opt.
F1: General Help
F2: Previous Values
F3: Optimized Defaults
F4: Save & Exit
ESC: Exit
Version 2.17.1255. Copyright (C) 2016 American Megatrends, Inc.
  
```

BIOS Menu 12: SATA Configuration

→ SATA Controller(s) [Enabled]

Use the **SATA Controller(s)** option to configure the serial ATA controller.

- **Enabled** **DEFAULT** Enables the on-board SATA controller.
- **Disabled** Disables the on-board SATA controller.

→ SATA Mode Selection [AHCI]

Use the **SATA Selection Mode** option to configure SATA devices.

- **AHCI** **DEFAULT** Configures SATA devices as AHCI device.
- **RAID** Configures SATA devices as RAID device.

5.3.9 USB Configuration

Use the **USB Configuration** menu (**BIOS Menu 13**) to read USB configuration information and configure the USB settings.

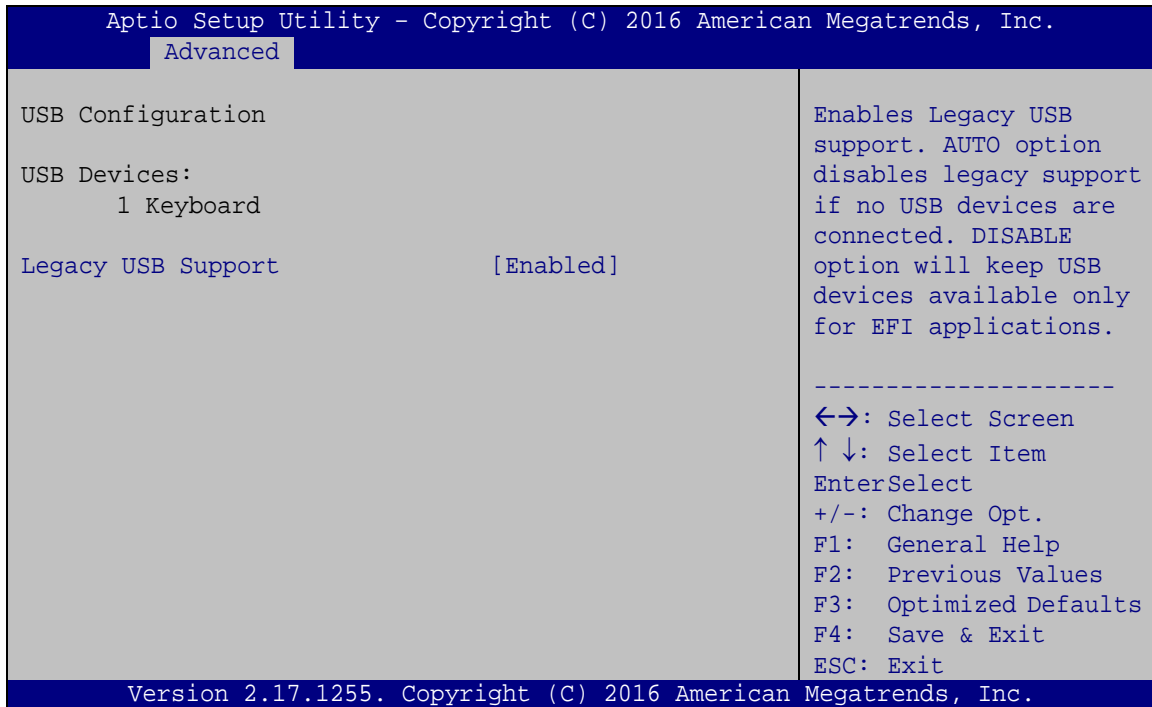

BIOS Menu 13: USB Configuration

➔ USB Devices

The **USB Devices** field lists the USB devices that are enabled on the system

➔ Legacy USB Support [Enabled]

Use the **Legacy USB Support** BIOS option to enable USB mouse and USB keyboard support. Normally if this option is not enabled, any attached USB mouse or USB keyboard does not become available until a USB compatible operating system is fully booted with all USB drivers loaded. When this option is enabled, any attached USB mouse or USB keyboard can control the system even when there is no USB driver loaded onto the system.

➔ **Enabled** **DEFAULT** Legacy USB support enabled

TANK-870-Q170 Embedded System

- ➔ **Disabled** Legacy USB support disabled
- ➔ **Auto** Legacy USB support disabled if no USB devices are connected

5.3.10 iEi Feature

Use the **iEi Feature** menu (**BIOS Menu 14**) to configure the iEi features.

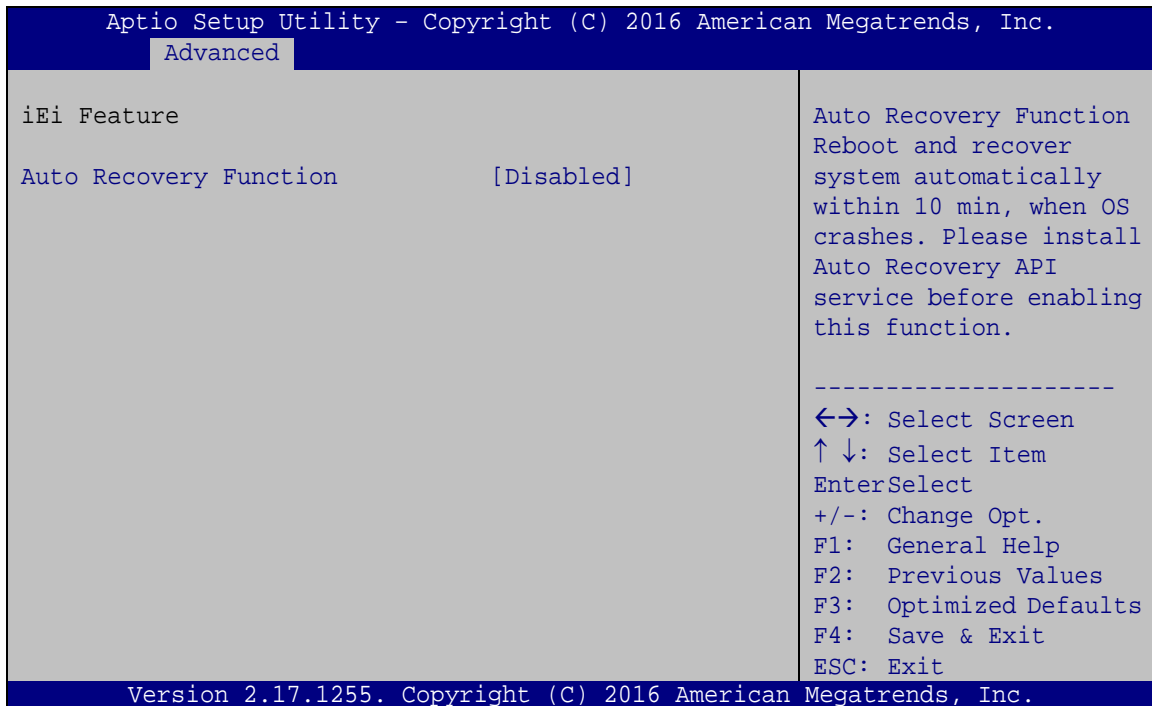

BIOS Menu 14: iEi Feature

- ➔ Auto Recovery Function [Disabled]

Use **Auto Recovery Function** option to enable or disable the auto recovery function.

- ➔ **Disabled** **DEFAULT** Disabled the auto recovery function
- ➔ **Enabled** Enabled the auto recovery function

5.3.11 iWDD H/W Monitor

The **iWDD H/W Monitor** menu (**BIOS Menu 15**) shows the operating temperature, fan speeds and system voltages.

```

Aptio Setup Utility - Copyright (C) 2016 American Megatrends, Inc.
Advanced
PC Health Status
CPU Temperature           :+34 C
System Temperature       :+32 C
CPU_FAN1 Speed           :N/A
+VCCCORE                  :+0.973 V
+V5S                      :+5.144 V
+V12S                    :+11.935 V
+VDDQ                     :+1.202 V
MBATTERY_IN1_EC          :N/A
SBATTERY_A_EC            :+18.963 V

Tcc Temperature          100
> Smart Fan Mode Configuration

If CPU Temperature reach Tcc
Temperature(40~100),
Then reduce CPU Frequency.

-----
<=>: Select Screen
↑↓: Select Item
Enter: Select
+/-: Change Opt.
F1: General Help
F2: Previous Values
F3: Optimized Defaults
F4: Save & Exit
ESC: Exit

Version 2.17.1255. Copyright (C) 2016 American Megatrends, Inc.
    
```

BIOS Menu 15: F81866 H/W Monitor

➔ PC Health Status

The following system parameters and values are shown. The system parameters that are monitored are:

- System Temperatures:
 - CPU Temperature
 - System Temperature
- Fan Speeds:
 - CPU_Fan1 Speed
- Voltages:
 - +VCCCORE

TANK-870-Q170 Embedded System

- +V5S
- +V12S
- +VDDQ
- MBATTERY_IN1_EC
- SBATTERY_A_EC

➔ Tcc Temperature [Enabled]

Use the **Tcc Temperature** option to change the **Tcc Temperature** value. If CPU Temperature reaches Tcc Temperature then reduces CPU Frequency.

- Minimum Value: 40°C
- Maximum Value: 100°C

5.3.11.1 Smart Fan Mode Configuration

Use the **Smart Fan Mode Configuration** submenu (**BIOS Menu 16**) to configure the smart fan temperature and speed settings.

```

Aptio Setup Utility - Copyright (C) 2016 American Megatrends, Inc.
  Advanced
Smart Fan Mode Configuration
CPU_FAN1 Smart Fan control      [Auto Mode]
CPU_FAN1 Start Temperature      65
CPU_FAN1 Off Temperature        55
CPU_FAN1 Start PWM              30
CPU_FAN1 Smart Fan Mode
Select

-----
<=>: Select Screen
↑ ↓: Select Item
Enter>Select
+/-: Change Opt.
F1:  General Help
F2:  Previous Values
F3:  Optimized
Defaults
F4:  Save & Exit
ESC: Exit

Version 2.17.1255. Copyright (C) 2016 American Megatrends, Inc.

```

BIOS Menu 16: Smart Fan Mode Configuration

➔ Smart Fan control [Auto Mode]

Use the **Smart Fan control** BIOS option to configure the CPU Smart Fan.

→ **Manual Mode**

The fan spins at the speed set in the manual setting

→ **Auto Mode**

DEFAULT

The fan adjusts its speed using these settings:

CPU_FAN1 Start Temperature

CPU_FAN1 Off Temperature

CPU_FAN1 Start PWM

→ CPU_FAN1 Start/Off Temperature

Use the + or – key to change the **CPU_FAN1 Start/Off Temperature** value. Enter a decimal number between 1 and 100.

→ CPU_FAN1 start PWM

Use the + or – key to change the **CPU_FAN1 start PWM** value. Enter a decimal number between 1 and 100.

5.4 Chipset

Use the **Chipset** menu (**BIOS Menu 17**) to access the PCH-IO and System Agent (SA) configuration menus.



WARNING!

Setting the wrong values for the Chipset BIOS selections in the Chipset BIOS menu may cause the system to malfunction.

TANK-870-Q170 Embedded System

```

Aptio Setup Utility - Copyright (C) 2016 American Megatrends, Inc.
Chipset
> System Agent (SA) Configuration
> PCH-IO Configuration

PCH Parameters
-----
<=>: Select Screen
↑ ↓: Select Item
Enter>Select
+/-: Change Opt.
F1: General Help
F2: Previous Values
F3: Optimized Defaults
F4: Save & Exit
ESC: Exit

Version 2.17.1255. Copyright (C) 2016 American Megatrends, Inc.
    
```

BIOS Menu 17: Chipset

5.4.1 System Agent (SA) Configuration

Use the **System Agent (SA) Configuration** menu (**BIOS Menu 18**) to configure the System Agent (SA) parameters.

```

Aptio Setup Utility - Copyright (C) 2016 American Megatrends, Inc.
Chipset
VT-d [Enabled]
> Graphics Configuration
> PEG Port Configuration
> Memory Configuration

Check to enable VT-d
function on MCH.
-----
-><=: Select Screen
↑ ↓: Select Item
Enter: Select
+/-: Change Opt.
F1: General Help
F2: Previous Values
F3: Optimized Defaults
F4: Save & Exit
ESC: Exit

Version 2.17.1255. Copyright (C) 2016 American Megatrends, Inc.
    
```

BIOS Menu 18: System Agent (SA) Configuration

→ VT-d [Disabled]

Use the **VT-d** option to enable or disable VT-d support.

→ **Disabled** **DEFAULT** Disable VT-d support.

➔ **Enabled** Enable VT-d support.

5.4.1.1 Graphics Configuration

Use the **Graphics Configuration (BIOS Menu 19)** menu to configure the video device connected to the system.

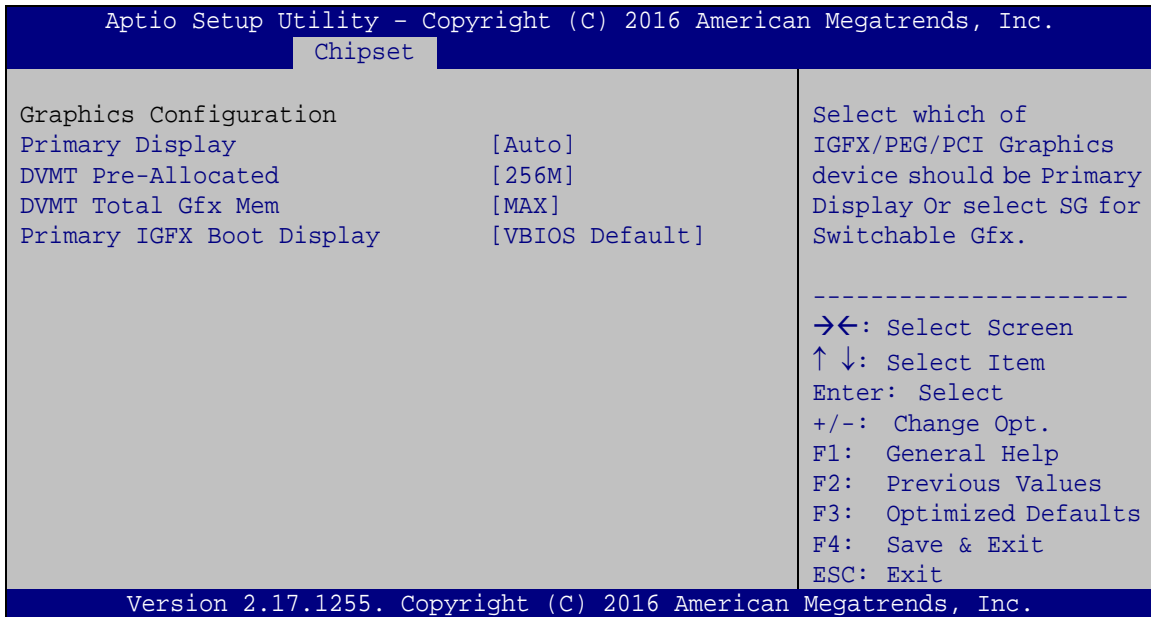

BIOS Menu 19: Graphics Configuration

➔ Primary Display [Auto]

Use the **Primary Display** option to select the primary graphics controller the system uses. The following options are available:

- Auto **Default**
- IGFX
- PEG
- PCI

➔ DVMT Pre-Allocated [256M]

Use the **DVMT Pre-Allocated** option to set the amount of system memory allocated to the integrated graphics processor when the system boots. The system memory allocated can

TANK-870-Q170 Embedded System

then only be used as graphics memory, and is no longer available to applications or the operating system. Configuration options are listed below:

- 32M
- 64M
- 128M
- 256M **Default**
- 512M

→ DVMT Total Gfx Mem [MAX]

Use the **DVMT Total Gfx Mem** option to select DVMT5.0 total graphic memory size used by the internal graphic device. The following options are available:

- 128M
- 256M
- MAX **Default**

→ Primary IGFX Boot Display [VBIOS Default]

Use the **Primary IGFX Boot Display** option to select the display device used by the system when it boots. Configuration options are listed below.

- VBIOS Default **DEFAULT**
- DP_HDMI1
- VGA1
- DP1

5.4.1.2 PEG Port Configuration

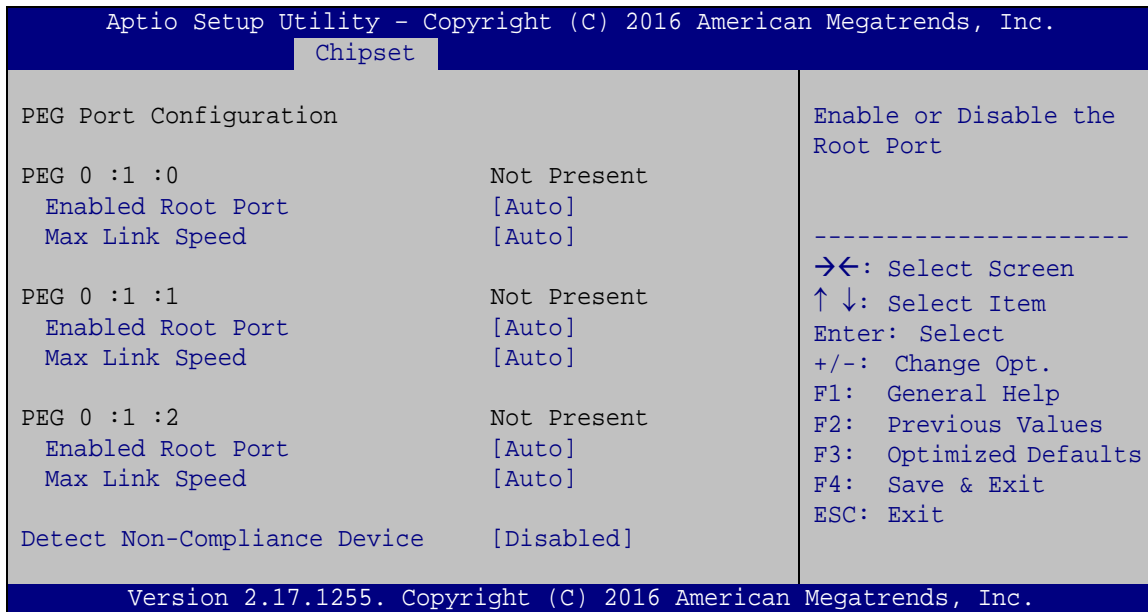

BIOS Menu 20: NB PCIe Configuration

→ Enable Root Port [Auto]

Use the **Enable Root Port** option to enable or disable the PCI Express (PEG) controller. The following options are available:

- Disabled
- Enabled
- Auto **Default**

→ Max Link Speed [Auto]

Use the **Max Link Speed** option to configure the PEG port max speed. The following options are available:

- Auto **Default**
- Gen1
- Gen2
- Gen3

TANK-870-Q170 Embedded System

→ Detect Non-Compliance Device [Disabled]

Use the **Detect Non-Compliance Device** option to enable or disable detecting a non-compliance PCI Express device in the PEG. The following options are available:

- Disabled **Default**
- Enabled

5.4.1.3 Memory Configuration

Use the **Memory Configuration** submenu (**BIOS Menu 21**) to view memory information.

```

Aptio Setup Utility - Copyright (C) 2016 American Megatrends, Inc.
  Chipset
-----
Memory Information
Memory Frequency          2133 Mhz
Total Memory              4096 MB
DIMM1                    4096 MB (DDR4)
DIMM2                    Not Present
-----
-><: Select Screen
↑↓: Select Item
Enter: Select
+/-: Change Opt.
F1: General Help
F2: Previous Values
F3: Optimized Defaults
F4: Save & Exit
ESC: Exit
Version 2.17.1255. Copyright (C) 2016 American Megatrends, Inc.

```

BIOS Menu 21: Memory Configuration

5.4.2 PCH-IO Configuration

Use the **PCH-IO Configuration** menu (**BIOS Menu 22**) to configure the PCH parameters.

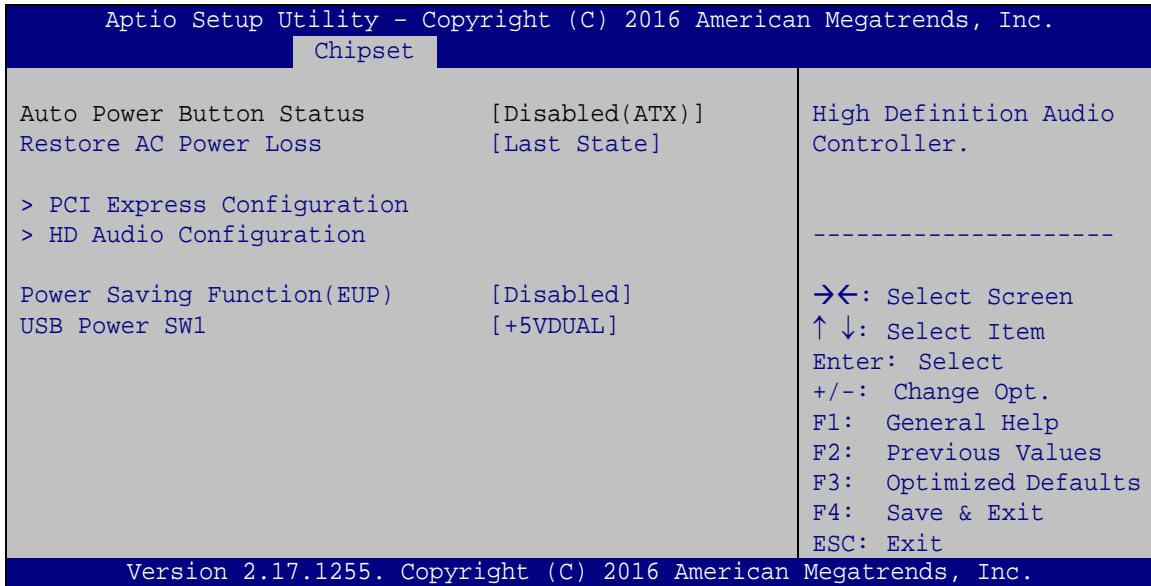

BIOS Menu 22: PCH-IO Configuration

→ Restore AC Power Loss [Last State]

Use the **Restore on AC Power Loss** option to specify what state the system returns to if there is a sudden loss of power to the system.

- **Power Off** The system remains turned off
- **Power On** The system turns on
- **Last State** **DEFAULT** The system returns to its previous state. If it was on, it turns itself on. If it was off, it remains off.

→ Power Saving Function (ERP) [Disabled]

Use the **Power Saving Function (ERP)** BIOS option to enable or disable the power saving function.

- **Disabled** **DEFAULT** Power saving function is disabled.
- **Enabled** Power saving function is enabled. It will reduce power consumption when the system is off.

TANK-870-Q170 Embedded System

➔ USB Power SW1 [+5V DUAL]

Use the **USB Power SW1** BIOS option to configure the USB power source for the corresponding USB connectors.

- ➔ **+5V** Sets the USB power source to +5V
- ➔ **+5VDUAL** **DEFAULT** Sets the USB power source to +5V dual

5.4.2.1 PCI Express Configuration

Use the **PCI Express Configuration** menu (**BIOS Menu 23**) to select the support type of the PCIe Mini slot.

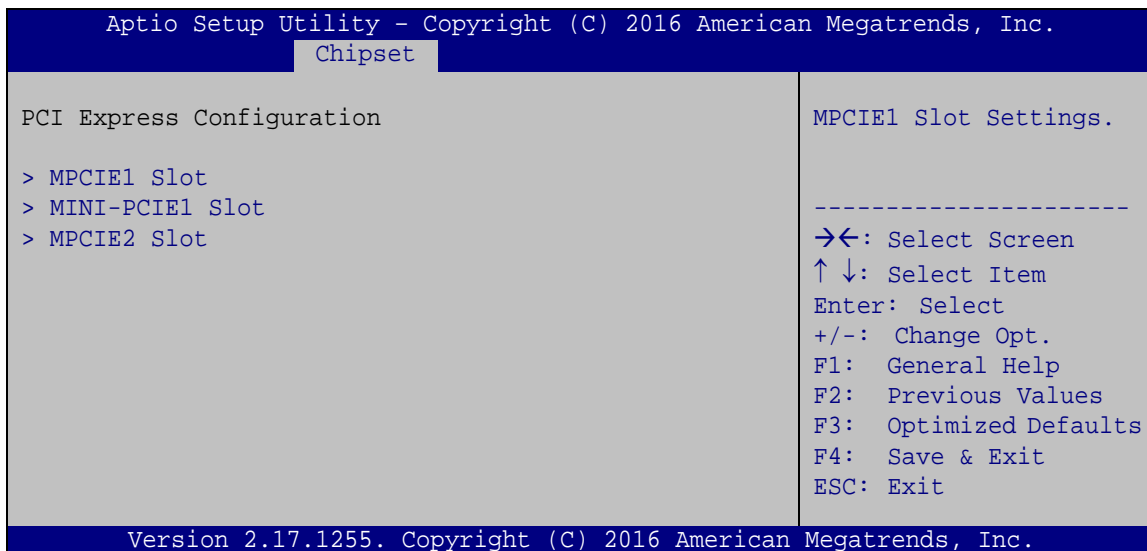

BIOS Menu 23: PCI Express Configuration

The **MPCIE1 Slot**, **MINI-PCIE1 Slot** and **MPCIE2 Slot** submenus all contain the following options:

➔ PCI Express Root [Enabled]

Use the **PCI Express Root** option to enable or disable the PCI Express (PEG) controller.

The following options are available:

- Disabled
- Enabled **Default**

→ PCIe Speed

Use PCIe Speed option to select the speed type of the PCIe Mini slot. The following options are available:

- Auto **Default**
- Gen1
- Gen2
- Gen3

→ Detect Non-Compliance Device [Disabled]

Use the **Detect Non-Compliance Device** option to enable or disable the “detect no-compliance PCIe device” function.

- **Disabled** **DEFAULT** Detect no-compliance PCIe device function is disabled
- **Enabled** Detect no-compliance PCIe device function is enabled. If will take more time at POST if it is enabled.

TANK-870-Q170 Embedded System

5.4.2.2 HD Audio Configuration

Use the **HD Audio Configuration** submenu (**BIOS Menu 24**) to configure the High Definition Audio codec.

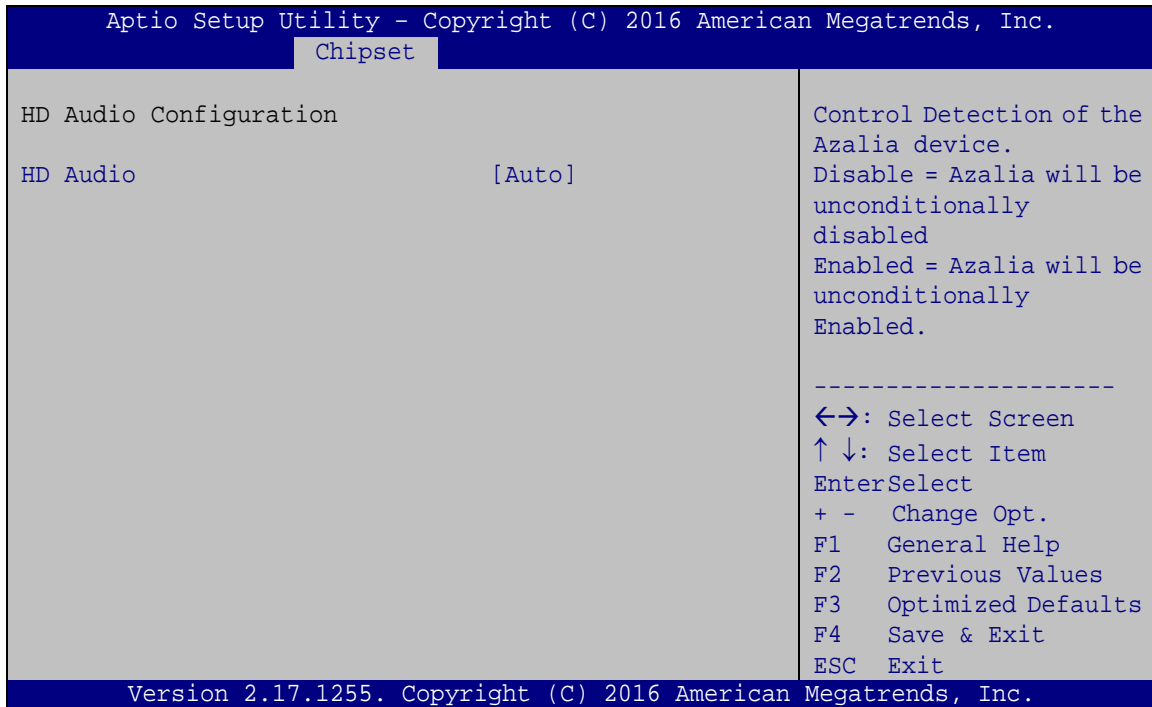

BIOS Menu 24: HD Audio Configuration

→ HD Audio [Auto]

Use the **HD Audio** BIOS option to enable or disable the High Definition Audio controller.

- **Disabled** The High Definition Audio controller is disabled.
- **Enabled** The High Definition Audio controller is enabled.
- **Auto** **DEFAULT** The onboard High Definition Audio controller automatically detected and enabled.

5.5 Security

Use the **Security** menu (**BIOS Menu 25**) to set system and user passwords.

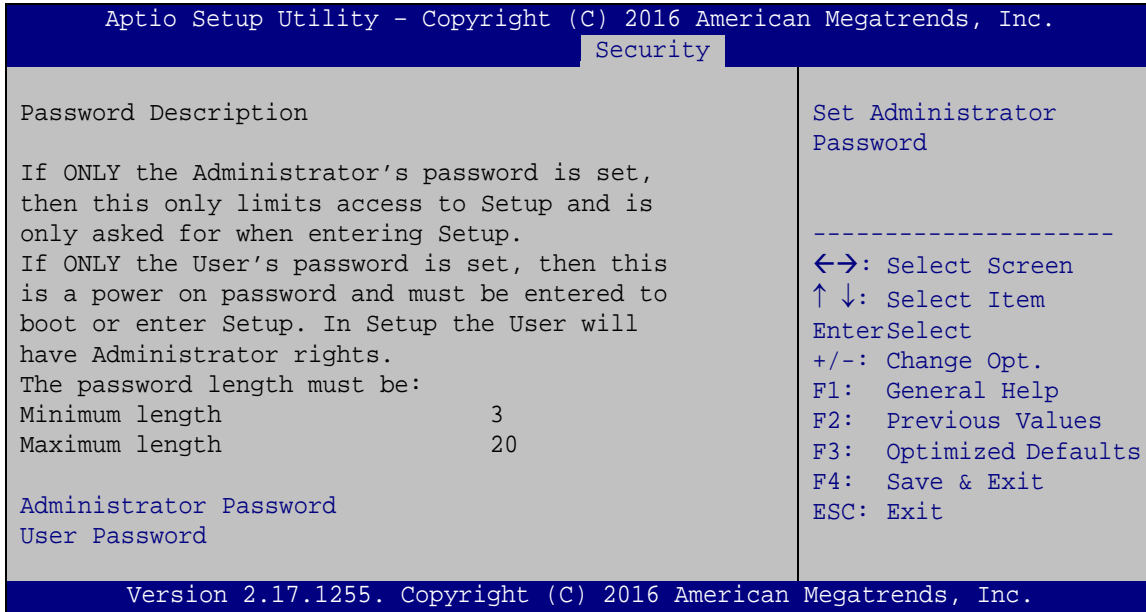

BIOS Menu 25: Security

➔ Administrator Password

Use the **Administrator Password** to set or change an administrator password.

➔ User Password

Use the **User Password** to set or change a user password.

TANK-870-Q170 Embedded System

5.6 Boot

Use the **Boot** menu (**BIOS Menu 26**) to configure system boot options.

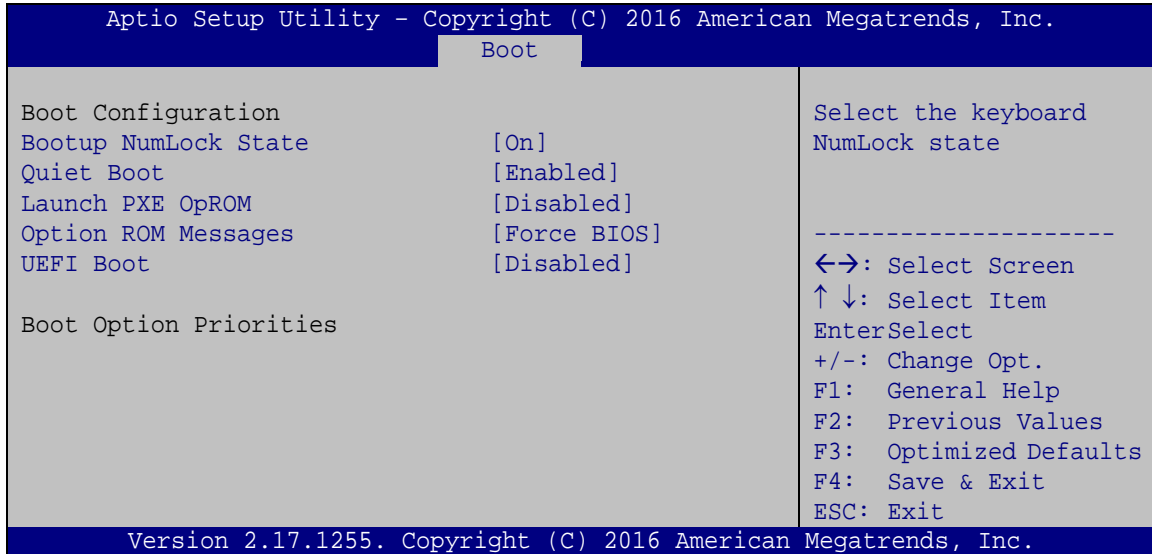

BIOS Menu 26: Boot

→ Bootup NumLock State [On]

Use the **Bootup NumLock State** BIOS option to specify if the number lock setting must be modified during boot up.

→ **On** **DEFAULT** Allows the Number Lock on the keyboard to be enabled automatically when the computer system boots up. This allows the immediate use of the 10-key numeric keypad located on the right side of the keyboard. To confirm this, the Number Lock LED light on the keyboard is lit.

→ **Off** Does not enable the keyboard Number Lock automatically. To use the 10-keys on the keyboard, press the Number Lock key located on the upper left-hand corner of the 10-key pad. The Number Lock LED on the keyboard lights up when the Number Lock is engaged.

→ Quiet Boot [Enabled]

Use the **Quiet Boot** BIOS option to select the screen display when the system boots.

- **Disabled** Normal POST messages displayed
- **Enabled** **DEFAULT** OEM Logo displayed instead of POST messages

→ Launch PXE OpROM [Disabled]

Use the **Launch PXE OpROM** option to enable or disable boot option for legacy network devices.

- **Disabled** **DEFAULT** Ignore all PXE Option ROMs
- **Enabled** Load PXE Option ROMs.

→ Option ROM Messages [Force BIOS]

Use the **Option ROM Messages** option to set the Option ROM display mode.

- **Force BIOS** **DEFAULT** Sets display mode to force BIOS.
- **Keep Current** Sets display mode to current.

→ UEFI Boot [Disabled]

Use the **UEFI Boot** option to enable or disable to boot from the UEFI devices.

- **Enabled** Boot from UEFI devices is enabled.
- **Disabled** **DEFAULT** Boot from UEFI devices is disabled.

TANK-870-Q170 Embedded System

5.7 Save & Exit

Use the **Save & Exit** menu (**BIOS Menu 27**) to load default BIOS values, optimal failsafe values and to save configuration changes.

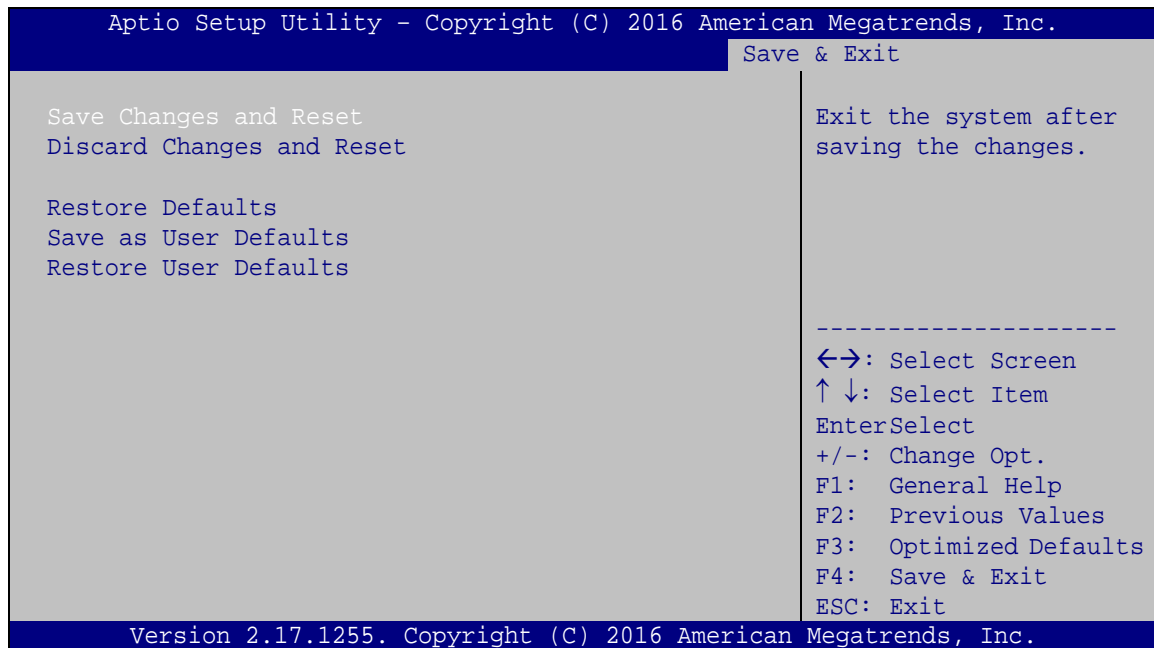
**BIOS Menu 27:Exit**

→ Save Changes and Reset

Use the **Save Changes and Reset** option to save the changes made to the BIOS options and reset the system.

→ Discard Changes and Reset

Use the **Discard Changes and Reset** option to exit the system without saving the changes made to the BIOS configuration setup program.

→ Restore Defaults

Use the **Restore Defaults** option to load the optimal default values for each of the parameters on the Setup menus. **F3 key can be used for this operation.**

➔ Save as User Defaults

Use the **Save as User Defaults** option to save the changes done so far as user defaults.

➔ Restore User Defaults

Use the **Restore User Defaults** option to restore the user defaults to all the setup options.

5.8 Server Mgmt

Use the **Server Mgmt** menu (BIOS Menu 28) to access the server management menus.

```

Aptio Setup Utility - Copyright (C) 2016 American Megatrends, Inc.
                                     Server Mgmt
-----
BMC Self Test Status                 FAILED
BMC Firmware Revision                Unknown
> System Event Log
> BMC network configuration

-----
<=>: Select Screen
↑ ↓: Select Item
Enter>Select
+ - Change Opt.
F1 General Help
F2 Previous Values
F3 Optimized Defaults
F4 Save & Exit
ESC Exit

Version 2.17.1255. Copyright (C) 2016 American Megatrends, Inc.
    
```

BIOS Menu 28: Server Mgmt

TANK-870-Q170 Embedded System

5.8.1.1 System Event Log

Use the **System Event Log** menu (BIOS Menu 29) to configure the event log.

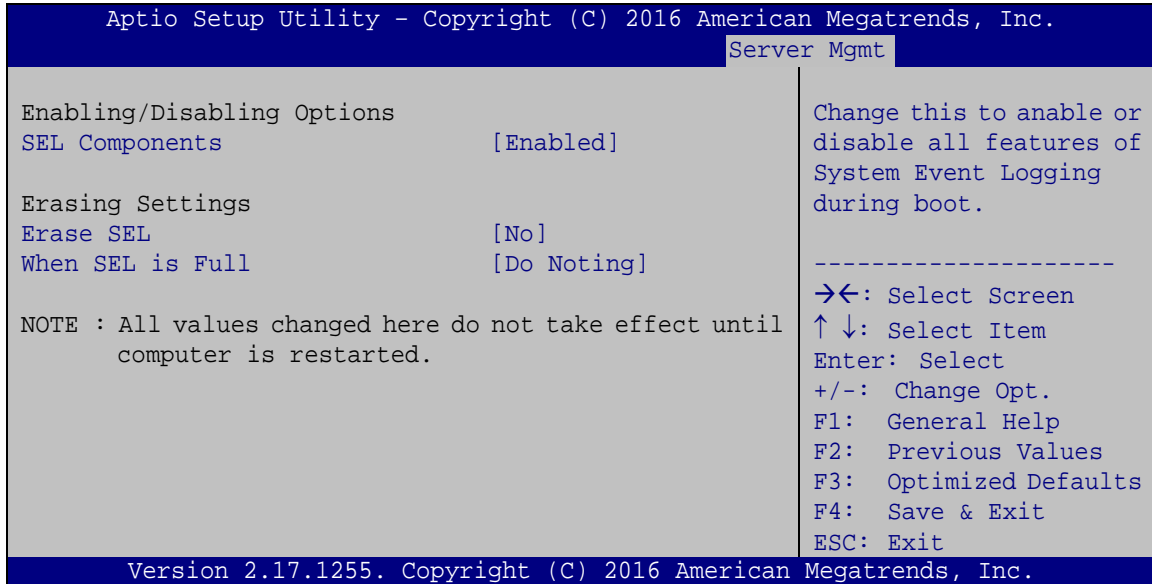

BIOS Menu 29: System Event Log

→ SEL Components [Enabled]

Use the **SEL Components** option to enable or disable all features of system event logging during boot.

→ **Disabled** Disables all features of system event logging during boot.

→ **Enabled** **DEFAULT** Enables all features of system event logging during boot.

→ Erase SEL [No]

Use **Erase SEL** option to select options for erasing SEL. The following options are available:

- No **Default**
- Yes, On next reset
- Yes, On every reset

➔ When SEL is Full [Do Nothing]

Use **When SEL is FULL** option to select options for reactions to a full SEL. The following options are available:

- Do Nothing **Default**
- Erase Immediately

5.8.1.2 BMC network configuration

Use the **BMC network configuration** menu (BIOS Menu 30) to configure BMC network parameters.

```

Aptio Setup Utility - Copyright (C) 2016 American Megatrends, Inc.
Server Mgmt
BMC network configuration
Lan channel 1
Configuration Address source [Unspecified]
Current Configuration Address source -
Station IP address -
Subnet mask -
Station MAC address -
Router IP address -
Router MAC address -
Select to configure LAN channel parameters statically or dynamically (by BIOS or BMC). Unspecified option will not modify any BMC network parameters during BIOS phase.
-----
-><: Select Screen
↑ ↓: Select Item
Enter: Select
+/-: Change Opt.
F1: General Help
F2: Previous Values
F3: Optimized Defaults
F4: Save & Exit
ESC: Exit
Version 2.17.1255. Copyright (C) 2016 American Megatrends, Inc.
    
```

BIOS Menu 30: PCH Azalia Configuration Menu

➔ Configuration Address source [Unspecified]

Use **Configuration Address source** option to configure LAN channel parameters. The following options are available:

- Unspecified **Default**
- Static
- DynamicBmcDhcp
- DynamicBmcNonDhcp

Appendix

A

Regulatory Compliance

DECLARATION OF CONFORMITY



This equipment is in conformity with the following EU directives:

- EMC Directive (2004/108/EC, 2014/30/EU)
- Low-Voltage Directive (2006/95/EC, 2014/35/EU)
- RoHS II Directive (2011/65/EU, 2015/863/EU)

If the user modifies and/or install other devices in the equipment, the CE conformity declaration may no longer apply.

If this equipment has telecommunications functionality, it also complies with the requirements of the Radio Equipment Directive 2014/53/EU.

English

IEI Integration Corp declares that this equipment is in compliance with the essential requirements and other relevant provisions of Directive 2014/53/EU.

Български [Bulgarian]

IEI Integration Corp. декларира, че този оборудване е в съответствие със съществените изисквания и другите приложим правила на Директива 2014/53/EU.

Česky [Czech]

IEI Integration Corp tímto prohlašuje, že tento zařizení je ve shodě s základními požadavky a dalšími příslušnými ustanoveními směrnice 2014/53/EU.

Dansk [Danish]

IEI Integration Corp erklærer herved, at følgende udstyr overholder de væsentlige krav og øvrige relevante krav i direktiv 2014/53/EU.

TANK-870-Q170 Embedded System

Deutsch [German]

IEI Integration Corp, erklärt dieses Gerät entspricht den grundlegenden Anforderungen und den weiteren entsprechenden Vorgaben der Richtlinie 2014/53/EU.

Eesti [Estonian]

IEI Integration Corp deklareerib seadme seadme vastavust direktiivi 2014/53/EÜ põhinõuetele ja nimetatud direktiivist tulenevatele teistele asjakohastele sätetele.

Español [Spanish]

IEI Integration Corp declara que el equipo cumple con los requisitos esenciales y cualesquiera otras disposiciones aplicables o exigibles de la Directiva 2014/53/EU.

Ελληνική [Greek]

IEI Integration Corp ΔΗΛΩΝΕΙ ΟΤΙ ΕΞΟΠΛΙΣΜΟΣ ΣΥΜΜΟΡΦΩΝΕΤΑΙ ΠΡΟΣ ΤΙΣ ΟΥΣΙΩΔΕΙΣ ΑΠΑΙΤΗΣΕΙΣ ΚΑΙ ΤΙΣ ΛΟΙΠΕΣ ΣΧΕΤΙΚΕΣ ΔΙΑΤΑΞΕΙΣ ΤΗΣ ΟΔΗΓΙΑΣ 2014/53/EU.

Français [French]

IEI Integration Corp déclare que l'appareil est conforme aux exigences essentielles et aux autres dispositions pertinentes de la directive 2014/53/EU.

Italiano [Italian]

IEI Integration Corp dichiara che questo apparecchio è conforme ai requisiti essenziali ed alle altre disposizioni pertinenti stabilite dalla direttiva 2014/53/EU.

Latviski [Latvian]

IEI Integration Corp deklarē, ka iekārta atbilst būtiskajām prasībām un citiem ar to saistītajiem noteikumiem Direktīvas 2014/53/EU.

Lietuvių [Lithuanian]

IEI Integration Corp deklaruoja, kad šis įranga atitinka esminius reikalavimus ir kitas 2014/53/EU Direktyvos nuostatas.

Nederlands [Dutch]

IEI Integration Corp dat het toestel in overeenstemming is met de essentiële eisen en de andere relevante bepalingen van richtlijn 2014/53/EU.

Malti [Maltese]

IEI Integration Corp jiddikjara li dan prodott jikkonforma mal-ħtiġijiet essenzjali u ma provvedimenti oħrajn relevanti li hemm fid-Dirrettiva 2014/53/EU.

Magyar [Hungarian]

IEI Integration Corp nyilatkozom, hogy a berendezés megfelel a vonatkozó alapvető követelményeknek és az 2014/53/EU irányelv egyéb előírásainak.

Polski [Polish]

IEI Integration Corp oświadcza, że wyrobu jest zgodny z zasadniczymi wymogami oraz pozostałymi stosownymi postanowieniami Dyrektywy 2014/53/EU.

Português [Portuguese]

IEI Integration Corp declara que este equipamento está conforme com os requisitos essenciais e outras disposições da Directiva 2014/53/EU.

Româna [Romanian]

IEI Integration Corp declară că acest echipament este în conformitate cu cerințele esențiale și cu celelalte prevederi relevante ale Directivei 2014/53/EU.

TANK-870-Q170 Embedded System

Slovensko [Slovenian]

IEI Integration Corp izjavlja, da je ta opreme v skladu z bistvenimi zahtevami in ostalimi relevantnimi določili direktive 2014/53/EU.

Slovensky [Slovak]

IEI Integration Corp týmto vyhlasuje, že zariadenia spĺňa základné požiadavky a všetky príslušné ustanovenia Smernice 2014/53/EU.

Suomi [Finnish]

IEI Integration Corp vakuuttaa täten että laitteet on direktiivin 2014/53/EU oleellisten vaatimusten ja sitä koskevien direktiivin muiden ehtojen mukainen.

Svenska [Swedish]

IEI Integration Corp förklarar att denna utrustningstyp står i överensstämmelse med de väsentliga egenskapskrav och övriga relevanta bestämmelser som framgår av direktiv 2014/53/EU.

FCC WARNING

This equipment complies with Part 15 of the FCC Rules. Operation is subject to the following two conditions:

- This device may not cause harmful interference, and
- This device must accept any interference received, including interference that may cause undesired operation.

This equipment has been tested and found to comply with the limits for a Class A digital device, pursuant to part 15 of the FCC Rules. These limits are designed to provide reasonable protection against harmful interference when the equipment is operated in a commercial environment. This equipment generates, uses, and can radiate radio frequency energy and, if not installed and used in accordance with the instruction manual, may cause harmful interference to radio communications. Operation of this equipment in a residential area is likely to cause harmful interference in which case the user will be required to correct the interference at his own expense.

Federal Communication Commission Interference Statement

This equipment has been assembled with components that comply with the limits for a Class B digital device, pursuant to Part 15 of the FCC Rules. These limits are designed to provide reasonable protection against harmful interference in a residential installation. This equipment generates, uses and can radiate radio frequency energy and, if not installed and used in accordance with the instructions, may cause harmful interference to radio communications. However, there is no guarantee that interference will not occur in a particular installation. If this equipment does cause harmful interference to radio or television reception, which can be determined by turning the equipment off and on, the user is encouraged to try to correct the interference by one of the following measures:

- Reorient or relocate the receiving antenna.
- Increase the separation between the equipment and receiver.
- Connect the equipment into an outlet on a circuit different from that to which the receiver is connected.
- Consult the dealer or an experienced radio/TV technician for help.

Appendix

B

BIOS Options

Below is a list of BIOS configuration options in the BIOS chapter.

➔ System Date [xx/xx/xx]	65
➔ System Time [xx:xx:xx]	65
➔ Security Device Support [Disable]	67
➔ ACPI Sleep State [S3 (Suspend to RAM)].....	67
➔ Intel AMT [Enabled]	68
➔ Un-Configure ME [Disabled]	68
➔ Serial Port [Enabled].....	70
➔ Change Settings [Auto]	70
➔ Serial Port [Enabled].....	70
➔ Change Settings [Auto]	71
➔ Serial Port [Enabled].....	71
➔ Change Settings [Auto]	71
➔ Serial Port [Enabled].....	72
➔ Change Settings [Auto]	72
➔ Serial Port [Enabled].....	73
➔ Change Settings [Auto]	73
➔ Device Mode [RS232].....	74
➔ Serial Port [Enabled].....	74
➔ Change Settings [Auto]	74
➔ Device Mode [RS232].....	75
➔ Wake System with Fixed Time [Disabled]	75
➔ Console Redirection [Disabled].....	77
➔ Terminal Type [ANSI].....	78
➔ Bits per second [115200].....	78
➔ Data Bits [8]	79
➔ Parity [None].....	79
➔ Stop Bits [1]	79
➔ Hyper-threading [Enabled].....	81
➔ Active Processor Cores [All]	81
➔ Intel Virtualization Technology [Disabled]	82
➔ EIST [Enabled].....	82
➔ CPU C states [Disabled].....	82
➔ Intel TXT(LT) Support [Disabled].....	82

TANK-870-Q170 Embedded System

➔	SATA Controller(s) [Enabled]	83
➔	SATA Mode Selection [AHCI].....	83
➔	USB Devices	84
➔	Legacy USB Support [Enabled].....	84
➔	Auto Recovery Function [Disabled]	85
➔	PC Health Status	86
➔	Tcc Temperature [Enabled].....	87
➔	Smart Fan control [Auto Mode]	87
➔	CPU_FAN1 Start/Off Temperature.....	88
➔	CPU_FAN1 start PWM	88
➔	VT-d [Disabled].....	89
➔	Primary Display [Auto]	90
➔	DVMT Pre-Allocated [256M]	90
➔	DVMT Total Gfx Mem [MAX].....	91
➔	Primary IGFX Boot Display [VBIOS Default]	91
➔	Enable Root Port [Auto]	92
➔	Max Link Speed [Auto]	92
➔	Detect Non-Compliance Device [Disabled]	93
➔	Restore AC Power Loss [Last State]	94
➔	Power Saving Function (ERP) [Disabled].....	94
➔	USB Power SW1 [+5V DUAL].....	95
➔	PCI Express Root [Enabled]	95
➔	PCIe Speed	96
➔	Detect Non-Compliance Device [Disabled]	96
➔	HD Audio [Auto].....	97
➔	Administrator Password	98
➔	User Password	98
➔	Bootup NumLock State [On].....	99
➔	Quiet Boot [Enabled]	100
➔	Launch PXE OpROM [Disabled]	100
➔	Option ROM Messages [Force BIOS].....	100
➔	UEFI Boot [Disabled]	100
➔	Save Changes and Reset	101
➔	Discard Changes and Reset	101
➔	Restore Defaults	101

→ Save as User Defaults	102
→ Restore User Defaults	102
→ SEL Components [Enabled].....	103
→ Erase SEL [No]	103
→ When SEL is Full [Do Nothing].....	104
→ Configuration Address source [Unspecified]	104

Appendix

C

Terminology

AC '97	Audio Codec 97 (AC'97) refers to a codec standard developed by Intel® in 1997.
ACPI	Advanced Configuration and Power Interface (ACPI) is an OS-directed configuration, power management, and thermal management interface.
AHCI	Advanced Host Controller Interface (AHCI) is a SATA Host controller register-level interface.
ATA	The Advanced Technology Attachment (ATA) interface connects storage devices including hard disks and CD-ROM drives to a computer.
ARMD	An ATAPI Removable Media Device (ARMD) is any ATAPI device that supports removable media, besides CD and DVD drives.
ASKIR	Amplitude Shift Keyed Infrared (ASKIR) is a form of modulation that represents a digital signal by varying the amplitude (“volume”) of the signal. A low amplitude signal represents a binary 0, while a high amplitude signal represents a binary 1.
BIOS	The Basic Input/Output System (BIOS) is firmware that is first run when the computer is turned on and can be configured by the end user
CODEC	The Compressor-Decompressor (CODEC) encodes and decodes digital audio data on the system.
CompactFlash®	CompactFlash® is a solid-state storage device. CompactFlash® devices use flash memory in a standard size enclosure. Type II is thicker than Type I, but a Type II slot can support both types.
CMOS	Complimentary metal-oxide-conductor is an integrated circuit used in chips like static RAM and microprocessors.
COM	COM refers to serial ports. Serial ports offer serial communication to expansion devices. The serial port on a personal computer is usually a male D-sub 9 connector.
DAC	The Digital-to-Analog Converter (DAC) converts digital signals to analog signals.
DDR	Double Data Rate refers to a data bus transferring data on both the rising and falling edges of the clock signal.

TANK-870-Q170 Embedded System

DMA	Direct Memory Access (DMA) enables some peripheral devices to bypass the system processor and communicate directly with the system memory.
DIMM	Dual Inline Memory Modules are a type of RAM that offer a 64-bit data bus and have separate electrical contacts on each side of the module.
DIO	The digital inputs and digital outputs are general control signals that control the on/off circuit of external devices or TTL devices. Data can be read or written to the selected address to enable the DIO functions.
EHCI	The Enhanced Host Controller Interface (EHCI) specification is a register-level interface description for USB 2.0 Host Controllers.
EIDE	Enhanced IDE (EIDE) is a newer IDE interface standard that has data transfer rates between 4.0 MBps and 16.6 MBps.
EIST	Enhanced Intel® SpeedStep Technology (EIST) allows users to modify the power consumption levels and processor performance through application software. The application software changes the bus-to-core frequency ratio and the processor core voltage.
FSB	The Front Side Bus (FSB) is the bi-directional communication channel between the processor and the Northbridge chipset.
GbE	Gigabit Ethernet (GbE) is an Ethernet version that transfers data at 1.0 Gbps and complies with the IEEE 802.3-2005 standard.
GPIO	General purpose input
HDD	Hard disk drive (HDD) is a type of magnetic, non-volatile computer storage device that stores digitally encoded data.
ICH	The Input/Output Control Hub (ICH) is an Intel® Southbridge chipset.
IrDA	Infrared Data Association (IrDA) specify infrared data transmission protocols used to enable electronic devices to wirelessly communicate with each other.
L1 Cache	The Level 1 Cache (L1 Cache) is a small memory cache built into the system processor.
L2 Cache	The Level 2 Cache (L2 Cache) is an external processor memory cache.

LCD	Liquid crystal display (LCD) is a flat, low-power display device that consists of two polarizing plates with a liquid crystal panel in between.
LVDS	Low-voltage differential signaling (LVDS) is a dual-wire, high-speed differential electrical signaling system commonly used to connect LCD displays to a computer.
POST	The Power-on Self Test (POST) is the pre-boot actions the system performs when the system is turned-on.
RAM	Random Access Memory (RAM) is volatile memory that loses data when power is lost. RAM has very fast data transfer rates compared to other storage like hard drives.
SATA	Serial ATA (SATA) is a serial communications bus designed for data transfers between storage devices and the computer chipsets. The SATA bus has transfer speeds up to 1.5 Gbps and the SATA II bus has data transfer speeds of up to 3.0 Gbps.
S.M.A.R.T	Self Monitoring Analysis and Reporting Technology (S.M.A.R.T) refers to automatic status checking technology implemented on hard disk drives.
UART	Universal Asynchronous Receiver-transmitter (UART) is responsible for asynchronous communications on the system and manages the system's serial communication (COM) ports.
UHCI	The Universal Host Controller Interface (UHCI) specification is a register-level interface description for USB 1.1 Host Controllers.
USB	The Universal Serial Bus (USB) is an external bus standard for interfacing devices. USB 1.1 supports 12Mbps data transfer rates and USB 2.0 supports 480Mbps data transfer rates.
VGA	The Video Graphics Array (VGA) is a graphics display system developed by IBM.

Appendix

D

Safety Precautions

D.1 Safety Precautions



WARNING:

The precautions outlined in this appendix should be strictly followed. Failure to follow these precautions may result in permanent damage to the TANK-870-Q170 Series.

Please follow the safety precautions outlined in the sections that follow:

D.1.1 General Safety Precautions

Please ensure the following safety precautions are adhered to at all times.

- ***Make sure the power is turned off and the power cord is disconnected*** when moving, installing or modifying the system.
- ***Do not apply voltage levels that exceed the specified voltage range.*** Doing so may cause fire and/or an electrical shock.
- ***Electric shocks can occur*** if opened while still powered on.
- ***Do not drop or insert any objects*** into the ventilation openings.
- ***If considerable amounts of dust, water, or fluids enter the system***, turn off the power supply immediately, unplug the power cord, and contact the system vendor.
- **DO NOT:**
 - Drop the system against a hard surface.
 - In a site where the ambient temperature exceeds the rated temperature

TANK-870-Q170 Embedded System

D.1.2 Anti-static Precautions

**WARNING:**

Failure to take ESD precautions during the installation of the TANK-870-Q170 Series may result in permanent damage to the TANK-870-Q170 Series and severe injury to the user.

Electrostatic discharge (ESD) can cause serious damage to electronic components, including the TANK-870-Q170 Series. Dry climates are especially susceptible to ESD. It is therefore critical that whenever the TANK-870-Q170 Series is opened and any of the electrical components are handled, the following anti-static precautions are strictly adhered to.

- ***Wear an anti-static wristband:*** Wearing a simple anti-static wristband can help to prevent ESD from damaging any electrical component.
- ***Self-grounding:*** Before handling any electrical component, touch any grounded conducting material. During the time the electrical component is handled, frequently touch any conducting materials that are connected to the ground.
- ***Use an anti-static pad:*** When configuring or working with an electrical component, place it on an anti-static pad. This reduces the possibility of ESD damage.
- ***Only handle the edges of the electrical component:*** When handling the electrical component, hold the electrical component by its edges.

D.1.3 Product Disposal

**CAUTION:**

Risk of explosion if battery is replaced by and incorrect type. Only certified engineers should replace the on-board battery.

Dispose of used batteries according to instructions and local regulations.

- Outside the European Union – If you wish to dispose of used electrical and electronic products outside the European Union, please contact your local authority so as to comply with the correct disposal method.
- Within the European Union – The device that produces less waste and is easier to recycle is classified as electronic device in terms of the European Directive 2012/19/EU (WEEE), and must not be disposed of as domestic garbage.

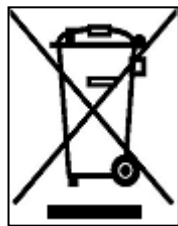

EU-wide legislation, as implemented in each Member State, requires that waste electrical and electronic products carrying the mark (left) must be disposed of separately from normal household waste. This includes monitors and electrical accessories, such as signal cables or power cords.

When you need to dispose of your display products, please follow the guidance of your local authority, or ask the shop where you purchased the product. The mark on electrical and electronic products only applies to the current European Union Member States.

Please follow the national guidelines for electrical and electronic product disposal.

D.2 Maintenance and Cleaning Precautions

When maintaining or cleaning the TANK-870-Q170 Series, please follow the guidelines below.

TANK-870-Q170 Embedded System

D.2.1 Maintenance and Cleaning

Prior to cleaning any part or component of the TANK-870-Q170 Series, please read the details below.

- The interior of the TANK-870-Q170 Series does not require cleaning. Keep fluids away from the TANK-870-Q170 Series interior.
- Be cautious of all small removable components when vacuuming the TANK-870-Q170 Series.
- Turn the TANK-870-Q170 Series off before cleaning the TANK-870-Q170 Series.
- Never drop any objects or liquids through the openings of the TANK-870-Q170 Series.
- Be cautious of any possible allergic reactions to solvents or chemicals used when cleaning the TANK-870-Q170 Series.
- Avoid eating, drinking and smoking within vicinity of the TANK-870-Q170 Series.

D.2.2 Cleaning Tools

Some components in the TANK-870-Q170 Series may only be cleaned using a product specifically designed for the purpose. In such case, the product will be explicitly mentioned in the cleaning tips. Below is a list of items to use when cleaning the TANK-870-Q170 Series.

- **Cloth** – Although paper towels or tissues can be used, a soft, clean piece of cloth is recommended when cleaning the TANK-870-Q170 Series.
- **Water or rubbing alcohol** – A cloth moistened with water or rubbing alcohol can be used to clean the TANK-870-Q170 Series.
- **Using solvents** – The use of solvents is not recommended when cleaning the TANK-870-Q170 Series as they may damage the plastic parts.
- **Vacuum cleaner** – Using a vacuum specifically designed for computers is one of the best methods of cleaning the TANK-870-Q170 Series. Dust and dirt can restrict the airflow in the TANK-870-Q170 Series and cause its circuitry to corrode.

- **Cotton swabs** - Cotton swabs moistened with rubbing alcohol or water are excellent tools for wiping hard to reach areas.
- **Foam swabs** - Whenever possible, it is best to use lint free swabs such as foam swabs for cleaning.

Appendix

E

Digital I/O Interface

E.1 Introduction

The DIO connector on the TANK-870-Q170 Series is interfaced to GPIO ports on the Super I/O chipset. The DIO has both 4-bit digital inputs and 4-bit digital outputs. The digital inputs and digital outputs are generally control signals that control the on/off circuit of external devices or TTL devices. Data can be read or written to the selected address to enable the DIO functions.



NOTE:

For further information, please refer to the datasheet for the Super I/O chipset.

The BIOS interrupt call **INT 15H** controls the digital I/O.

INT 15H:

AH – 6FH
<u>Sub-function:</u>
AL – 8 : Set the digital port as INPUT
AL : Digital I/O input value

TANK-870-Q170 Embedded System

E.2 Assembly Language Sample 1

```

MOV     AX, 6F08H      ;setting the digital port as input
INT     15H           ;

```

AL low byte = value

AH – 6FH
<u>Sub-function:</u>
AL – 9 : Set the digital port as OUTPUT
BL : Digital I/O input value

E.3 Assembly Language Sample 2

```

MOV     AX, 6F09H      ;setting the digital port as output
MOV     BL, 09H        ;digital value is 09H
INT     15H           ;

```

Digital Output is 1001b

Appendix

F

Hazardous Materials Disclosure

TANK-870-Q170 Embedded System

The details provided in this appendix are to ensure that the product is compliant with the Peoples Republic of China (China) RoHS standards. The table below acknowledges the presences of small quantities of certain materials in the product, and is applicable to China RoHS only.

A label will be placed on each product to indicate the estimated “Environmentally Friendly Use Period” (EFUP). This is an estimate of the number of years that these substances would “not leak out or undergo abrupt change.” This product may contain replaceable sub-assemblies/components which have a shorter EFUP such as batteries and lamps. These components will be separately marked.

Please refer to the following table.

Part Name	Toxic or Hazardous Substances and Elements					
	Lead (Pb)	Mercury (Hg)	Cadmium (Cd)	Hexavalent Chromium (CR(VI))	Polybrominated Biphenyls (PBB)	Polybrominated Diphenyl Ethers (PBDE)
Housing	O	O	O	O	O	O
Display	O	O	O	O	O	O
Printed Circuit Board	O	O	O	O	O	O
Metal Fasteners	O	O	O	O	O	O
Cable Assembly	O	O	O	O	O	O
Fan Assembly	O	O	O	O	O	O
Power Supply Assemblies	O	O	O	O	O	O
Battery	O	O	O	O	O	O
<p>O: This toxic or hazardous substance is contained in all of the homogeneous materials for the part is below the limit requirement in SJ/T11363-2006 (now replaced by GB/T 26572-2011).</p> <p>X: This toxic or hazardous substance is contained in at least one of the homogeneous materials for this part is above the limit requirement in SJ/T11363-2006 (now replaced by GB/T 26572-2011).</p>						

此附件旨在确保本产品符合中国 RoHS 标准。以下表格标示此产品中某有毒物质的含量符合中国 RoHS 标准规定的限量要求。

本产品上会附有“环境友好使用期限”的标签，此期限是估算这些物质“不会有泄漏或突变”的年限。本产品可能包含有较短的环境友好使用期限的可替换元件，像是电池或灯管，这些元件将会单独标示出来。

部件名称	有毒有害物质或元素					
	铅 (Pb)	汞 (Hg)	镉 (Cd)	六价铬 (CR(VI))	多溴联苯 (PBB)	多溴二苯 醚 (PBDE)
壳体	O	O	O	O	O	O
显示	O	O	O	O	O	O
印刷电路板	O	O	O	O	O	O
金属螺帽	O	O	O	O	O	O
电缆组装	O	O	O	O	O	O
风扇组装	O	O	O	O	O	O
电力供应组装	O	O	O	O	O	O
电池	O	O	O	O	O	O

O: 表示该有毒有害物质在该部件所有物质材料中的含量均在 SJ/T 11363-2006 (现由 GB/T 26572-2011 取代) 标准规定的限量要求以下。

X: 表示该有毒有害物质至少在该部件的某一均质材料中的含量超出 SJ/T 11363-2006 (现由 GB/T 26572-2011 取代) 标准规定的限量要求。