

BYTEM-103-PC

User Manual

Revision	Release Date
V1.0	2015/09/01

Copyright © 2013 IBASE Technology Inc. All Rights Reserved.

No part of this manual, including the products and software described in it, may be reproduced, transmitted, transcribed, stored in a retrieval system, or translated into any language in any form or by any means, except documentation kept by the purchaser for backup purposes, without the express written permission of IBASE Technology INC. (“IBASE”).

Products and corporate names mentioned in this manual may or may not be registered trademarks or copyrights of their respective companies, and are used for identification purposes only. All trademarks are the property of their respective owners.

Every effort has been made to ensure that the contents of this manual are correct and up to date. However, the manufacturer makes no guarantee regarding the accuracy of its contents, and reserves the right to make changes without prior notice.

Table of Contents

<i>Safety Information</i>	iii
Setting up your system	iii
Care during use	iv
Acknowledgments	v
CHAPTER 1 INTRODUCTION	1
1.1 General Description	1
1.2 System Specification	2
1.2.1 Hardware Specifications	2
1.2.2 Dimensions	3
1.2.3 I/O View.....	5
1.3 Accessory List	8
1.4 Installation	8
CHAPTER 2 MOTHERBOARD INTRODUCTION	9
2.1 Introduction	9
2.2 Installing the Memory	12
2.3 Setting Jumpers.....	13
CHAPTER 3 BIOS SETUP	29
CHAPTER 4 DRIVERS INSTALLATION	43
4.1 Intel Chipset Software Installation Utility	43
4.2 VGA Drivers Installation.....	44
4.3 Realtek High Definition Audio Driver Installation	45
4.4 Intel Trusted Execution Engine Installation	49
Appendix	54

Safety Information

Your BYTEM product is designed and tested to meet the latest standards of safety for information technology equipment. However, to ensure your safety, it is important that you read the following safety instructions

Setting up your system

- Read and follow all instructions in the documentation before you operate your system.
- Do not use this product near water.
- Set up the system on a stable surface. Do not secure the system on any unstable plane.
- Do not place this product on an unstable cart, stand, or table. The product may fall, causing serious damage to the product.
- Slots and openings on the chassis are for ventilation. Do not block or cover these openings. Make sure you leave plenty of space around the system for ventilation.
Never insert objects of any kind into the ventilation openings.
- This system should be operated from the type of power indicated on the marking label. If you are not sure of the type of power available, consult your dealer or local power company.
- Use this product in environments with ambient temperatures between -25°C and 55°C.
- If you use an extension cord, make sure that the total ampere rating of the devices plugged into the extension cord does not exceed its ampere rating.
- DO NOT LEAVE THIS EQUIPMENT IN AN ENVIRONMENT WHERE THE STORAGE TEMPERATURE MAY GO BELOW -30° C OR ABOVE 70° C. THIS COULD DAMAGE THE EQUIPMENT. THE EQUIPMENT SHOULD BE IN A CONTROLLED ENVIRONMENT.

Care during use

- Do not walk on the power cord or allow anything to rest on it.
- Do not spill water or any other liquids on your system.
- When the system is turned off, a small amount of electrical current still flows. Always unplug all power, and network cables from the power outlets before cleaning the system.
- If you encounter the following technical problems with the product, unplug the power cord and contact a qualified service technician or your retailer.
 - The power cord or plug is damaged.
 - Liquid has been spilled into the system.
 - The system does not function properly even if you follow the operating instructions.
 - The system was dropped or the cabinet is damaged.

Lithium-Ion Battery Warning

CAUTION: Danger of explosion if battery is incorrectly replaced. Replace only with the same or equivalent type recommended by the manufacturer. Dispose of used batteries according to the manufacturer's instructions.

NO DISASSEMBLY

The warranty does not apply to the products that have been disassembled by users.

WARNING

HAZARDOUS MOVING PARTS

KEEP FINGERS AND OTHER BODY PARTS AWAY

Acknowledgments

- AMI is a registered trademark of AMI Software International, Inc.
- AMD and ATI are registered trademarks of AMD Corporation.
- Microsoft Windows is a registered trademark of Microsoft Corporation.
- FINTEK is a registered trademark of FINTEK Electronics Corporation.
- REALTEK is a registered trademark of REALTEK Electronics Corporation.
- All other product names or trademarks are properties of their respective owners.

CHAPTER 1 INTRODUCTION

1.1 General Description

BYTEM-103-PC, an ALL-in-ONE Panel PC that is powered by an Intel® Atom™ processor to provide high computing performance with low power consumption. The fanless BYTEM series operates silently and reliably in harsh environments. It comes with two SODIMM slots to accommodate up to 8GB of DDR3L 1333MHz system memory and one 2.5" SATA HDD for data storage. It features two Gigabit Ethernet, one 10/100M LAN with M12 connector and one RS-232/422/485 port. The unit is equipped with a front bezel that has IP65-rated protection.

The BYTEM-103-PC supports 24V DC power input and optional 48V DC, 72V DC & 110V DC input and is EN50155 certified, which makes it ideal for railway or any other industrial applications.



1.2 System Specification

1.2.1 Hardware Specifications

Model Name	BYTEM-103-PC
System Mainboard	IB897
CPU	Intel® Atom E3845 (Quad-Core @ 1.91 GHz)
Chipset	Integrated in Intel® Atom™ SoC
Memory	2x DDR3L SO-DIMM, up to 8GB, Default DDR3L 4GB(4GBx1)
I/O Interface	1 x USB 3.0 flag type blue color 1 x USB 2.0 Type A flag type 1 x 4 pin M12 A-code connector USB 2.0 1 x D-SUB9 RS-232/422/485 COM1 1 x DP port 2 x Gigabit LAN (RJ45) 1 x 4-pin M12 D-code connector 10/100 M LAN 1 x M12 4-pin power input connector
Storage	1 x 2.5" SATA HDD with easy accessibility; Default 64G SSD
Expansion Slots	None
Power Supply	24V (default) DC input (EN50155 S2/C2), optional 48V DC, 72V DC & 110V DC
LCD Size	10.4" TFT LCD
LCD Color	16.2M
LCD Resolution	1024 x 768
LCD Brightness	500
LCD View Angle (H°/V°)	176/176
LCD Contrast	1000:1
Backlight MTBF	50,000 hrs
Touch Screen	Projected capacitive touch
Construction	Aluminum front bezel and steel back cover
Mounting	VESA 75X75, 100x100 mm and wall mount
Dimensions (W)x(D)x(H) mm	275 x 238.5 x 79
Operating Temperature	-25°C~ 55°C (EN50155-T1)
Storage Temperature	-30°C ~ 70°C
Relative Humidity	10%~90% (non-condensing)
Protection Class	IP65 for front bezel / IP54 for whole unit with I/O cover
Certification	CE/FCC Class B, EN50155: 2007
Operating System Support	Windows 8 32/64bit, Windows 7 Pro for Embedded 64bit, WES7 64bit

•This specification is subject to change without prior notice.

1.2.2 Dimensions

BYTEM-103-PC

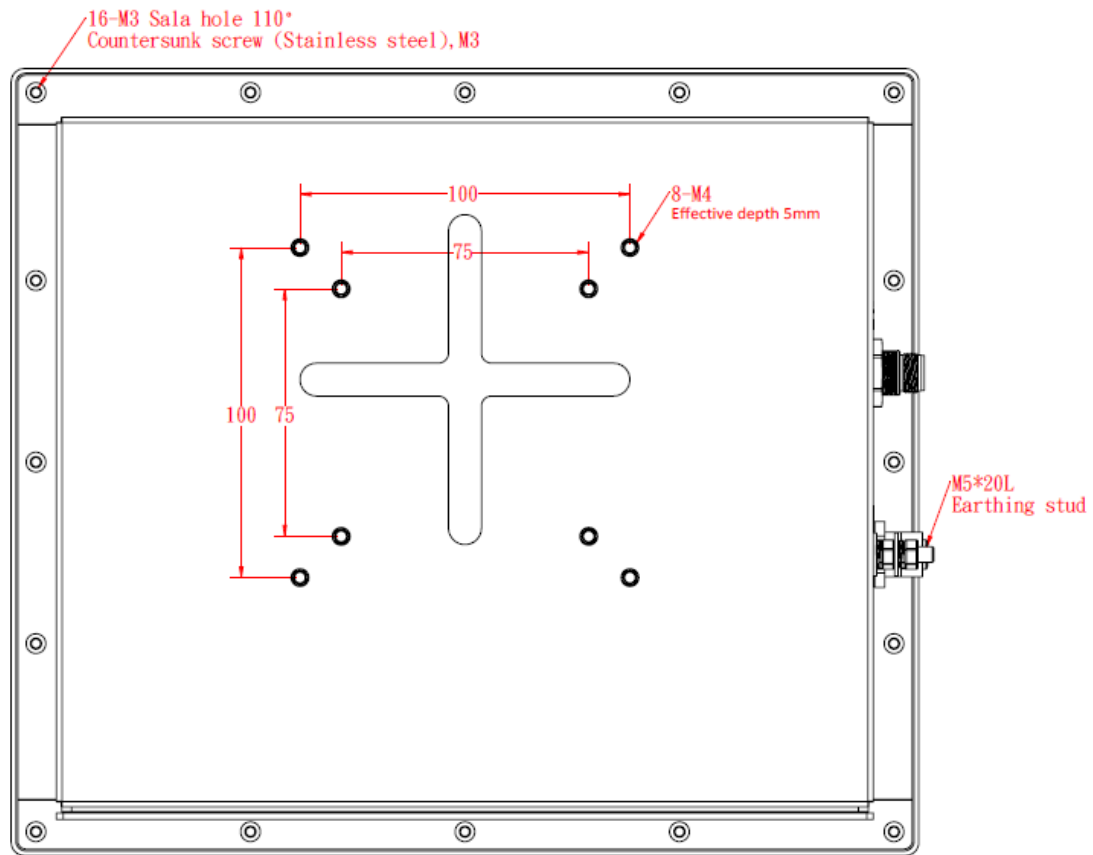
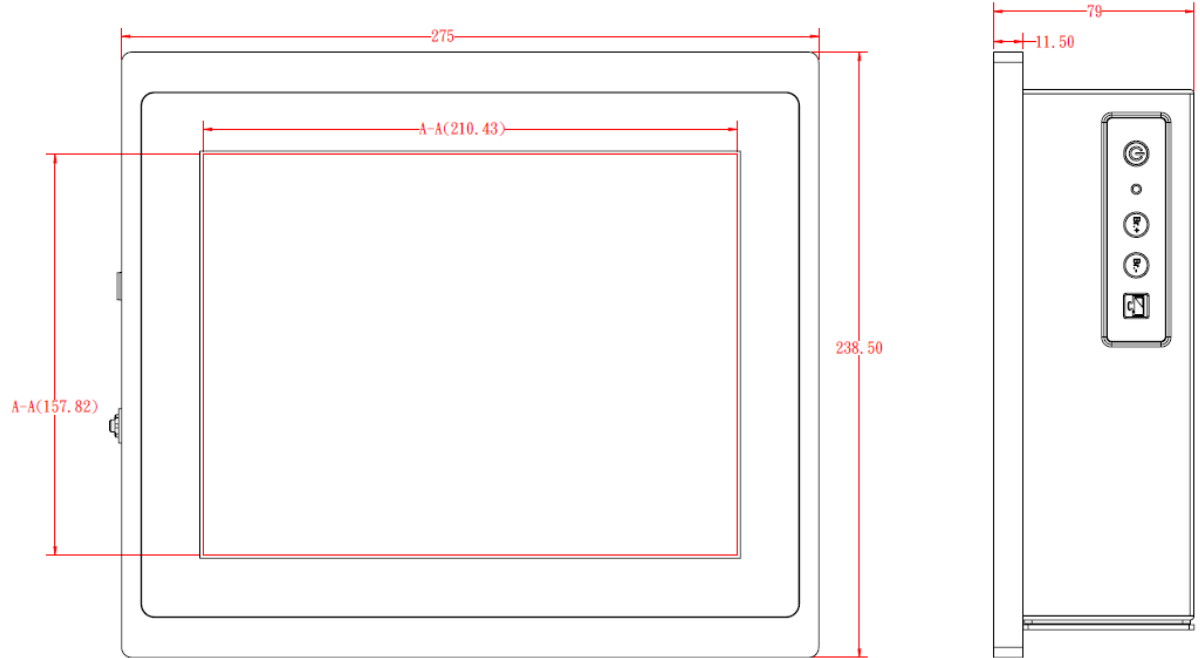

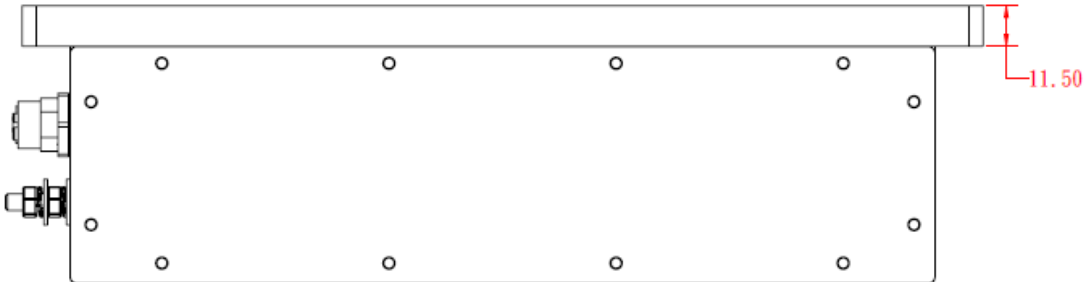

1.2.3 I/O View

BYTEM-103-PC I/O Side



M12 Power Input Connector

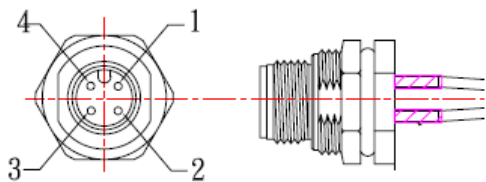

- Pin 1: NC
- Pin 2: Power+
- Pin 3: Ground
- Pin 4: Power-

M12 10/100M LAN Port

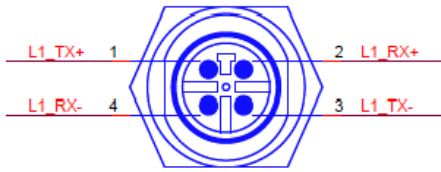

Pin 1: LAN TX+

Pin 2: LAN RX+

Pin 3: LAN TX

Pin 4: LAN RX-

Control Keypad

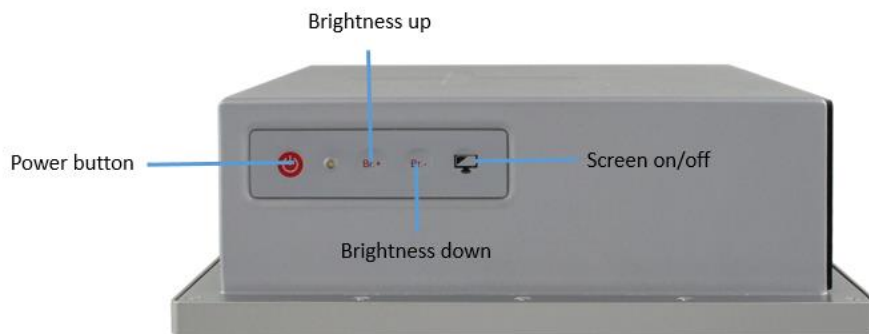

Power on/off:

The push button is used to power on or power off the system. The push button can be configured in the Windows power setting.

Brightness Up and Down:

These buttons are used to adjust the panel brightness (0~100). There are 8 increments.

Screen On/Off

This switch is used to turn off or turn on the screen. It does not work when the system is powered off.

1.3 Accessory List

Part No.	Description	Quantity
1	Power external cable	1 pc
2	LAN external cable	1 pc
3	Driver CD	1 pc
4	Optional 24V power adaptor & power cord	1 pc

1.4 Installation

1.4.1 Installing HDD/SSD

1. Loosen the screw as shown in the picture.
2. Pull out the HDD/SSD bracket and replace the HDD/SSD module.



CHAPTER 2 MOTHERBOARD INTRODUCTION

2.1 Introduction

IB897 is a 3.5-inch single board computer based on the Intel® Atom™ E3800 series processor. It supports two DDR3L (1.35V) SODIMM sockets for a maximum memory capacity of 8GB.

IB897 features Intel's 7th generation (Gen 7) graphics engine and has CRT and DisplayPort video display interface, as well as 24-bit LVDS dual channel interface with the use of the NXP PTN3460 device.

Onboard connectivity available includes two SATA II ports, two COM ports, one USB 3.0 port, four USB2.0 ports, audio, two Mini PCI-e(x1) slots, and Micro SD. Power input is provided by a +9~+30V DC in connector.

Product Name	IB897
Form Factor	3.5" disk size SBC
SoC Type/Speed	Intel® Atom™ QC E3845 /2MB cache/1.91GHz (IB897-I45&I45P) Intel® Atom™ DC E3827 /1MB cache/1.75 GHz (IB897-I27&I27P) Intel® Atom™ SC E3815 /512KB cache/1.46 GHz (IB897-I15& I15P) Package = FCBGA1170, 25mmx27mm, 22nm, Tj= -40 ° C to +110 ° C
BIOS	AMI BIOS
Memory	Intel® Atom™ SoC integrated memory controller Supports DDR3L (1.35V only), Non-ECC memory only 2 x DDR3 SO-DIMM socket [IB897-I45_P/IB897-I27_P], 8GB max. 1 x DDR3 SO-DIMM socket [IB897-I15_P], 4GB max.
VGA	Intel® Gen7 w/4 EUs graphics engines DisplayPort x 1 [Supports up to 2560x1200@60Hz] CRT x 1 via pin header [Supports up to 1920x1080@60Hz]
LVDS	24-bit dual channel via NXP PTN3460 thru eDP (Supports up to 1920x1200 @ 60 Hz)
LAN	Intel® I210IT PCIe Gigabit LAN x 2
USB	Intel® Atom™ SoC built-in USB host controller Supports USB 2.0 x 4 ports; USB 3.0 x 1 port, extra USB 2.0 x4 ports (Thru SMSC HUB USB2514)

Serial ATA	Intel® Atom™ SoC built-in SATA II controller, supports 2 ports
Audio	Intel® Atom™ SoC built-in HD audio controller + Realtek ALC269QHD Codec w/ class-D speaker amplifier (2.3W per channel @ 5V power supply) [7mm x 7mm @ 48-QFN]; support 2-channel audio out + amp
LPC I/O	Nuvoton NCT5523D [64-pin LQFP, 7x7x1.4mm] - COM #1 (RS232/422/485) [EXAR SP339EER1 x 1 for jumper-less] - COM #2 (RS-232 only) [Hardware Monitor]: 2x thermal inputs; 2x voltage monitoring
Digital IO	4 in & 4 out
Expansion Slots	Mini PCI-e socket x2 (1x Full-sized+1x Half-sized,) **Full length MiniPCle (1x) supports mSATA**
Edge Connector	DB9 for COM1, DisplayPort, RJ45 x 2 for LAN 1 & 2 USB 2.0 vertical connector x 1, USB 3.0 vertical connector x 1 LED indicators (red+green) x1 for power and HDD status & power button x 1 (IB897-I45/I27/I15) 4-pin header for LED indicator & 2-pin header for power button via cable (IB897-I45P/I27P/I15P)
Onboard Header/ Connector	2x8 pin header for CRT; 2x4 pin header for 2x USB 2.0 DF20 socket connector x2 for 24-bit dual channel LVDS 4-pin box header for backlight/brightness control (PWM) 2x6 pin box header for Audio, 4-pin header for speaker 2x5 pin box header for COM2 2x5 pin headers for LPC (80-port card debugging purpose) Mini PCI-e(1x) connector x2, 5-pin box header for smart battery SATA connector x2 for SATA device 4-pin power connector (JST type, for SATA device) 2-pin connector for power input, Micro SD slot (type 3.3V)
Watchdog	Yes (256 segments, 0, 1, 2...255 sec/min)
Power Connector	9V ~ 30V DC-in thru onboard 2-pin connector
Others	iSMART 2.0 [Auto-scheduler / Power resume]
OS Support	Windows 8.1 / Embedded; Windows 7 / Embedded, Linux
RoHS / REACH/ CE / FCC	Yes / Yes / Yes / Class B
Operating Temp.	-40 ° C to +85 ° C
Board Size	102mm x 147mm

Board Dimensions for [IB897-I45/I27/I15]

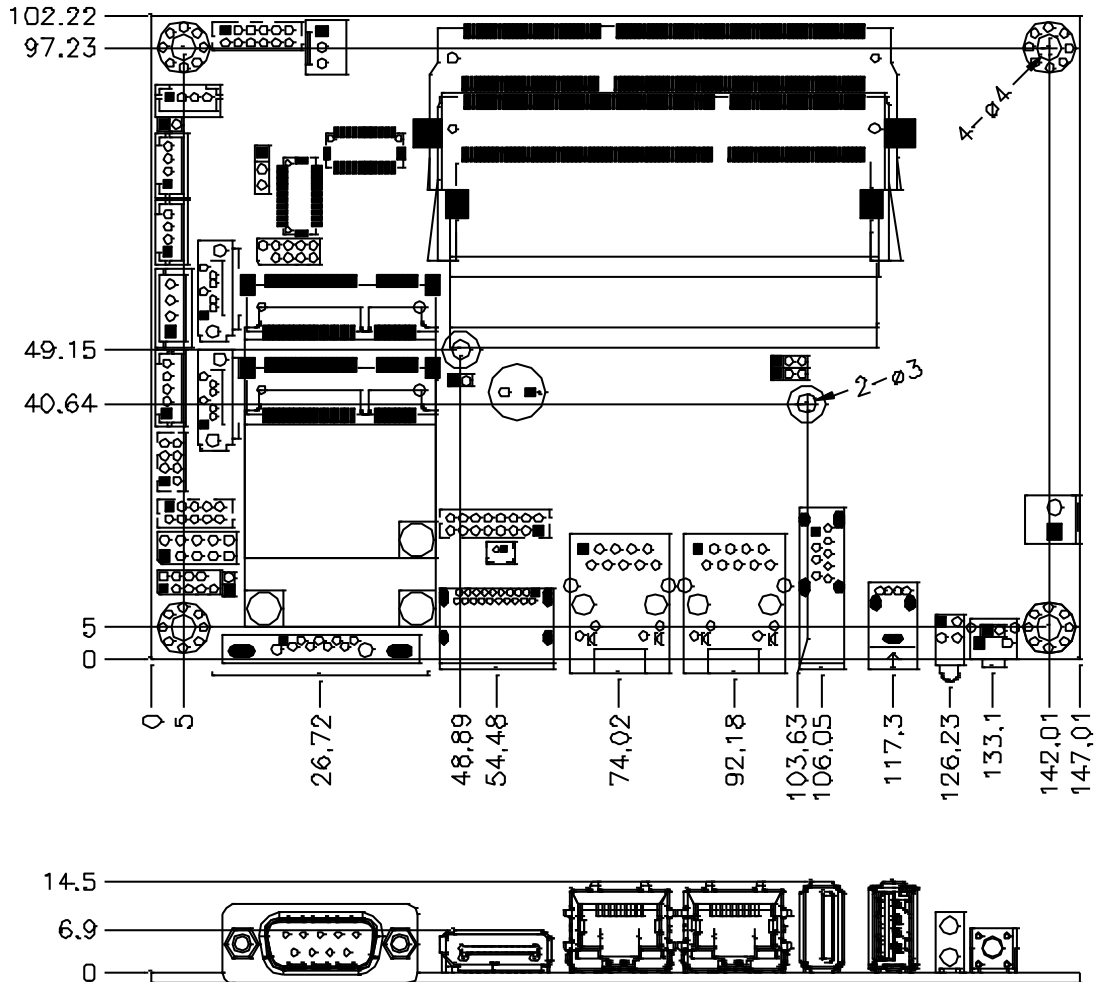

2.2 Installing the Memory

The IB897 board supports two DDR3L memory sockets for a maximum of 8GB.

Installing and Removing Memory Modules

To install the DDR3 modules, locate the memory slot on the board and perform the following steps:

1. Hold the DDR3 module so that the key of the DDR3 module is aligned with that on the memory slot.
2. Gently push the DDR3 module in an upright position until the clips of the slot close to hold the DDR3 module in place when the DDR3 module touches the bottom of the slot.
3. To remove the DDR3 module, press the clips with both hands.

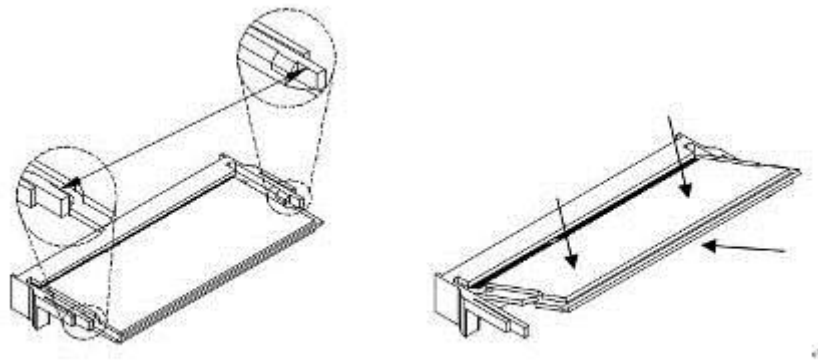

**** Channel-A slot must be installed with memory module before boot up****

2.3 Setting Jumpers

Jumpers are used on IB897 to select various settings and features according to your needs and applications. Contact your supplier if you have doubts about the best configuration for your needs. The following shows the jumpers/connectors on IB897.

Jumper Locations on IB897

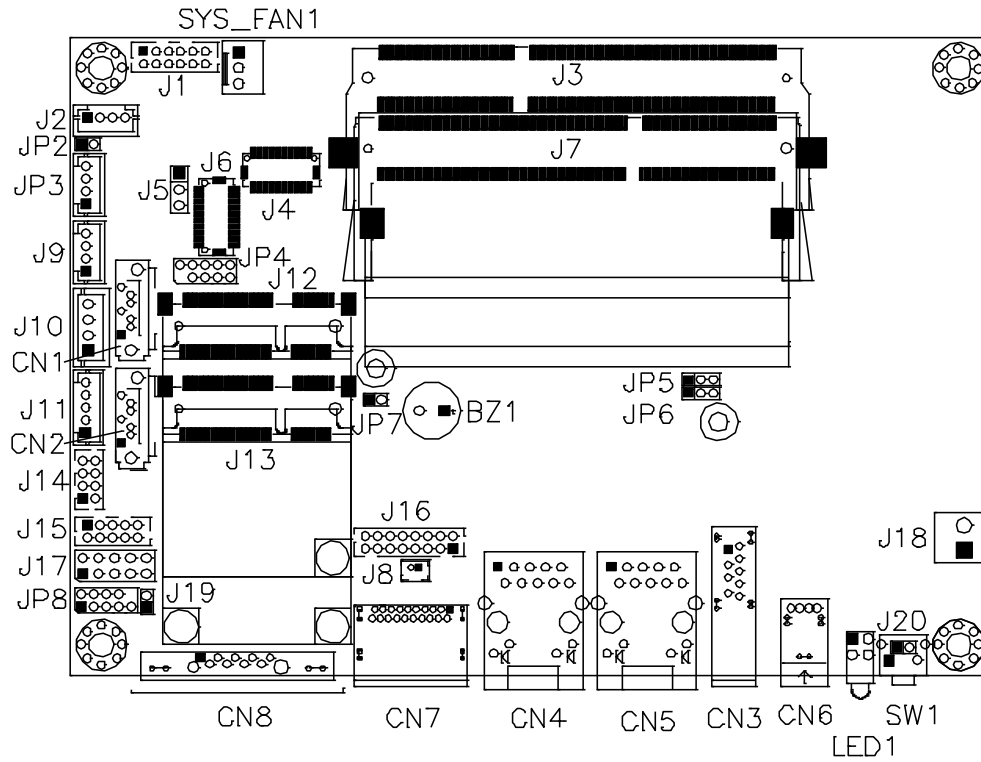

JP2: LVDS Panel Brightness Control Selection

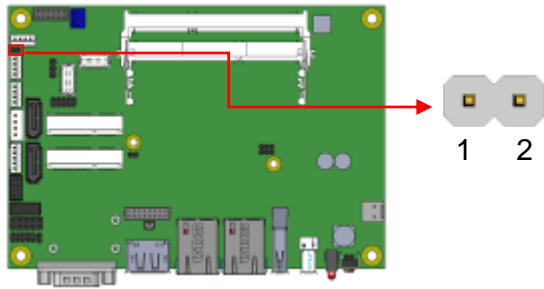

JP2	Brightness Control (PWM mode)
Open	3.3V
Close	5V (default)

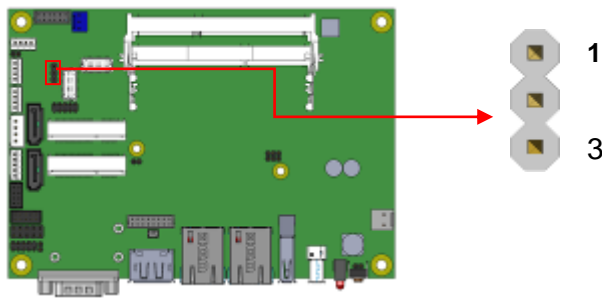

J5: LVDS Panel Power Selection

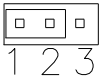
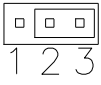

J5	Setting	Panel Voltage
	Pin 1-2 Short/Closed	3.3V (default)
	Pin 2-3 Short/Closed	5V

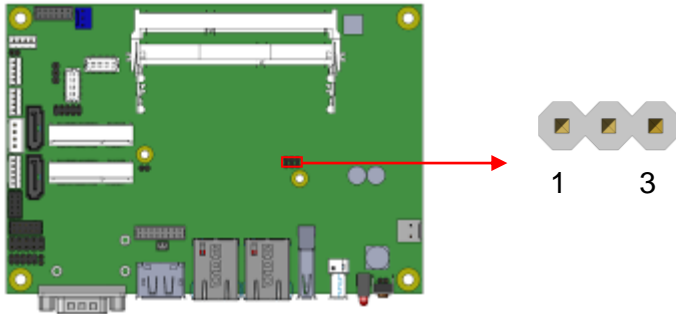

JP5: Clear ME Contents

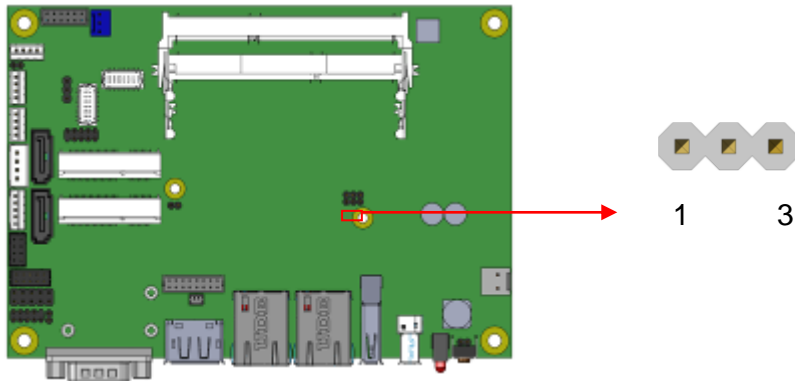

JP5	Setting	Function
	Pin 1-2 Short/Closed	Normal
	Pin 2-3 Short/Closed	Clear ME Register

JP6: Clear CMOS Contents



JP6	Setting	Function
	Pin 1-2 Short/Closed	Normal
	Pin 2-3 Short/Closed	Clear CMOS

Connector Locations on IB897-I45/I27/I15

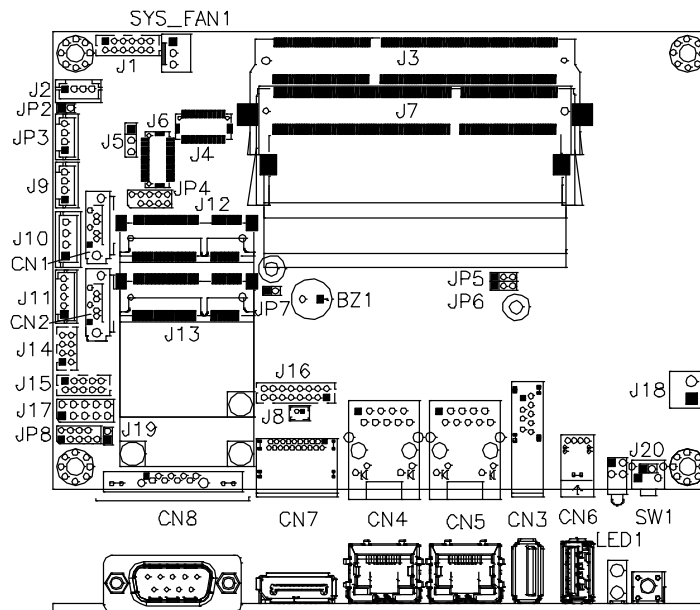

Bottom Side

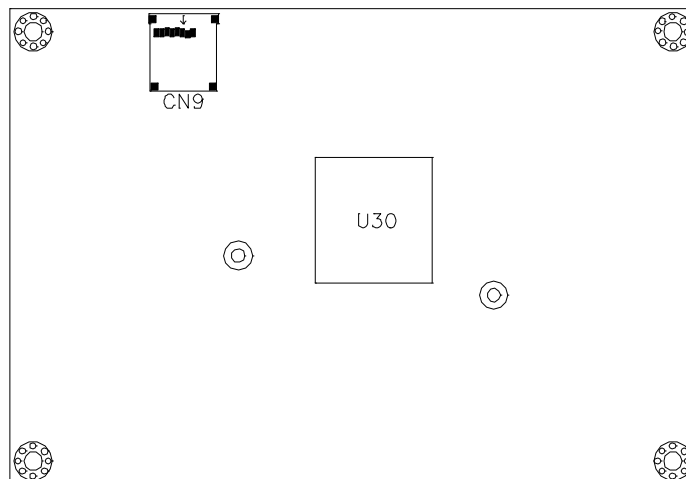

CN3: USB3.0 Connector

CN4, CN5: Gigabit LAN Connector

CN4: Intel® I210IT Connector

CN5: Intel® I210IT Connector

CN6: USB2.0 Connector

CN7: DP Connector

CN8: DB9 Connector (COM1)

Signal Name	Pin #	Pin #	Signal Name
DCD, Data carrier detect	1	6	DSR, Data set ready
RXD, Receive data	2	7	RTS, Request to send
TXD, Transmit data	3	8	CTS, Clear to send
DTR, Data terminal ready	4	9	RI, Ring indicator
GND, ground	5	10	Not Used

COM1 is jumper-less for RS-232, RS-422 and RS-485 and is to be configured with BIOS Selection.

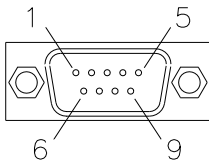

Pin #	Signal Name		
	RS-232	R2-422	RS-485
1	DCD	TX-	DATA-
2	RX	TX+	DATA+
3	TX	RX+	NC
4	DTR	RX-	NC
5	Ground	Ground	Ground
6	DSR	NC	NC
7	RTS	NC	NC
8	CTS	NC	NC
9	RI	NC	NC
10	NC	NC	NC

CN9: Micro SD (3.3V) Connector**SW1: Power Switch [For IB897-I45/I27/I15]**

LED1:**Power LED and HDD LED Connector [For IB897-I45/I27/I15]**

The green LED at the bottom is power LED. The red LED on top is the HDD LED.

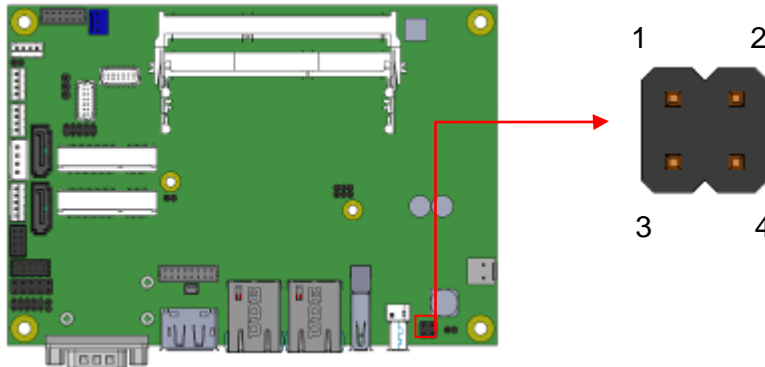

Signal Name	Pin #	Pin #	Signal Name
VCC3	1	2	HDD_LED
VCC5	3	4	GND

CN1: SATAII /share mSATA/ Connectors

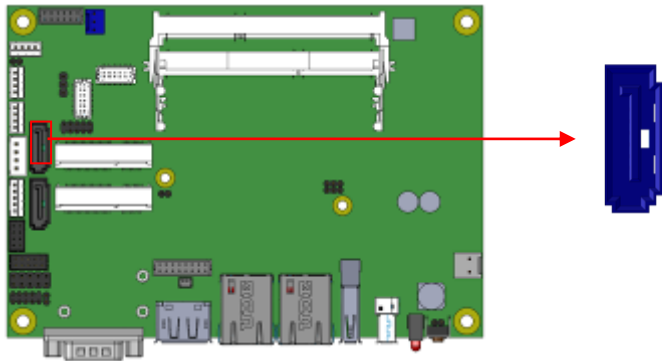

CN2: SATAII Connectors

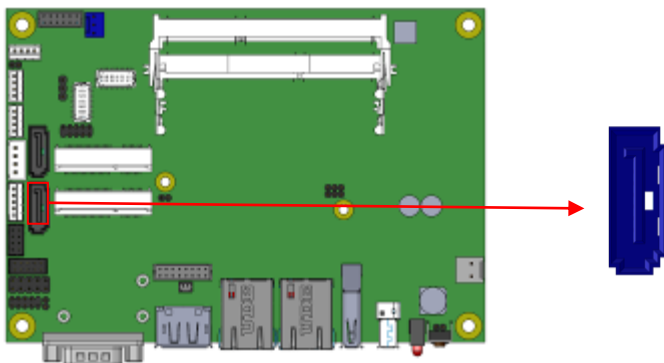

SYS_FAN1: SYSTEM Fan Power Connector

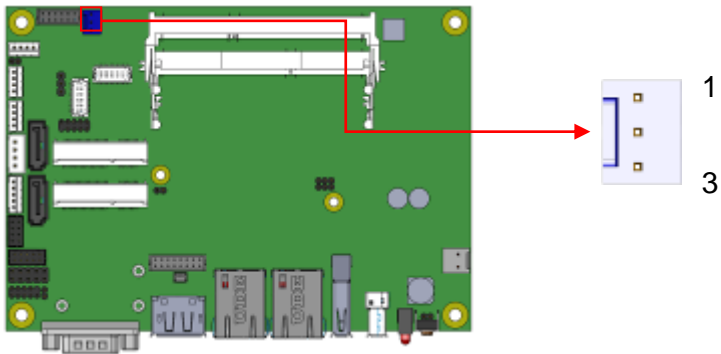

Pin #	Signal Name
1	Ground
2	+12V(500mA)
3	Rotation detection

J1: Audio Connector (DF11-12DP-2DSA)

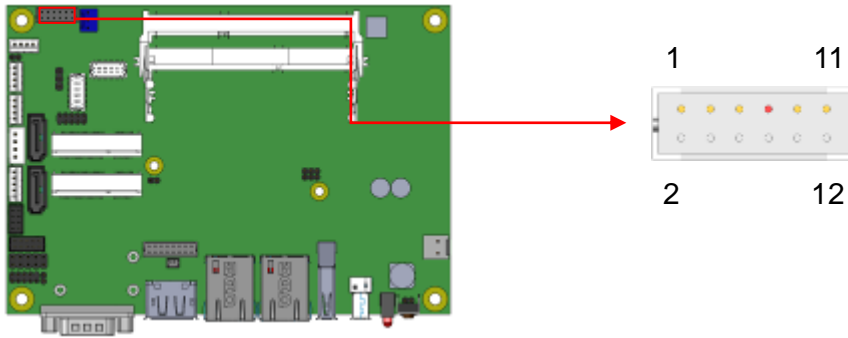

Signal Name	Pin #	Pin #	Signal Name
LINEOUT_R	2	1	LINEOUT_L
Ground	4	3	JD_FRONT
LINEIN_R	6	5	LINEIN_L
Ground	8	7	JD_LINEIN
MIC-R	10	9	MIC_L
Ground	12	11	JD_MIC1

J2: Amplify Connector (JST B4B-PH-K-S)

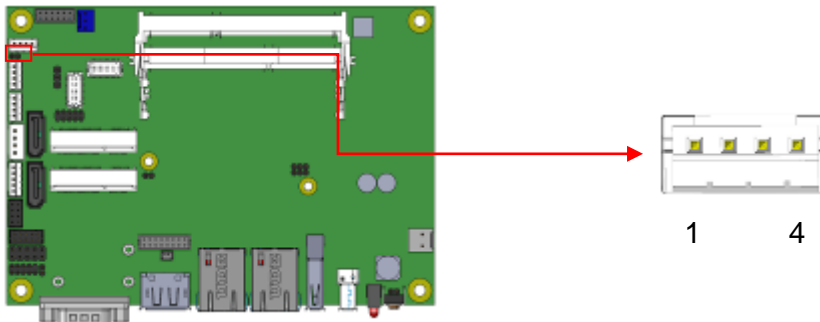

Pin #	Signal Name
1	OUTL+
2	OUTL-
3	OUTR-
4	OUTR+

J7: DDR3L SO-DIMM (CH-A) Sockets

**** Please note CH-A must be installed before boot up****

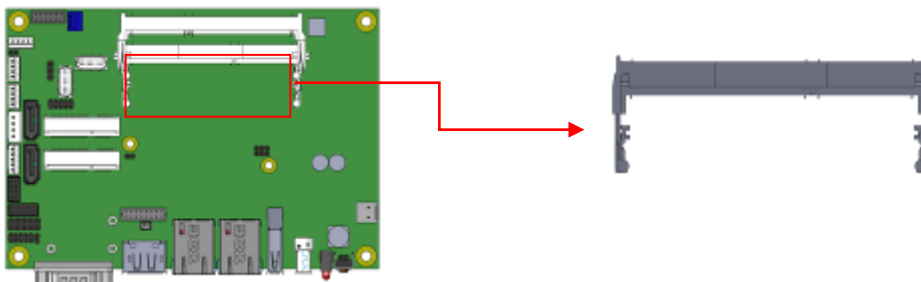

J3: DDR3L SO-DIMM (CH-B) Sockets

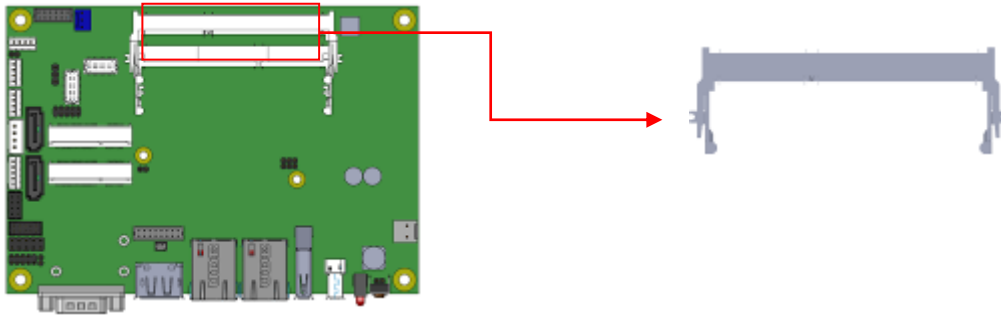

J4, J6: LVDS Connectors (DF20G-20DP-1V)

J4: First Channel LVDS

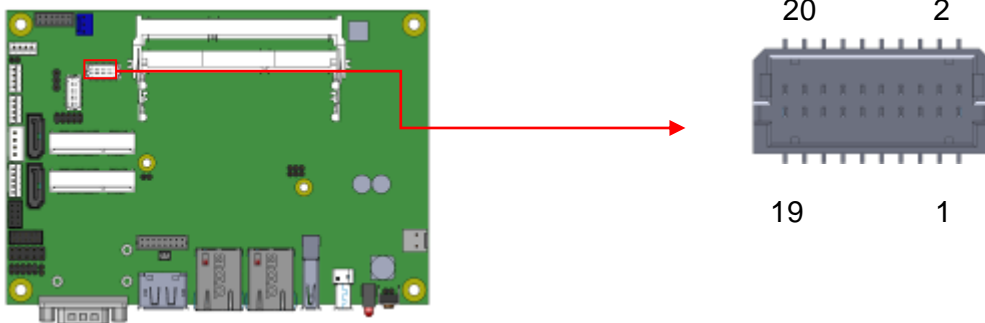

J6: Second Channel LVDS

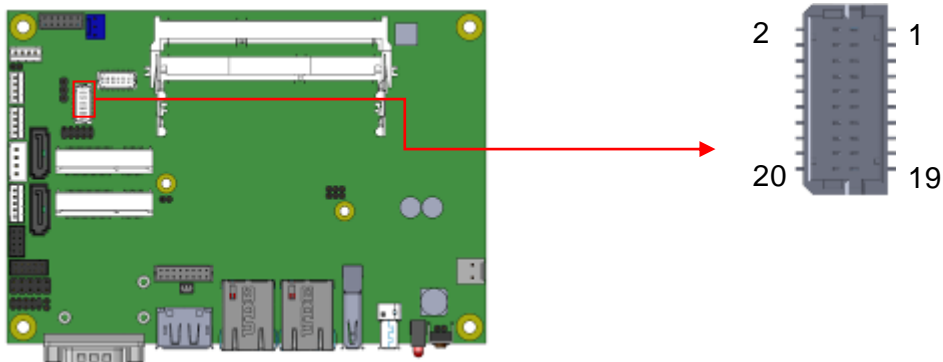

Signal Name	Pin #	Pin #	Signal Name
TX0N	2	1	TX0P
Ground	4	3	Ground
TX1N	6	5	TX1P
Ground	8	7	Ground
TX2N	10	9	TX2P
Ground	12	11	Ground
CLKN	14	13	CLKP
Ground	16	15	Ground
TX3N	18	17	TX3P
Power (1A)	20	19	Power

J9: MCU Flash Connector (factory use only)

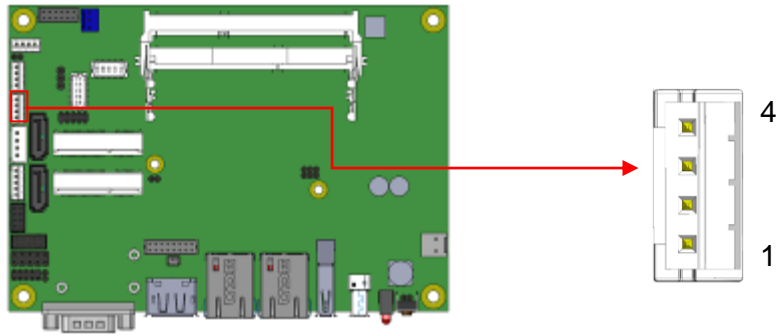

J10: SATA HDD Power Connectors (JST B4B-XH-A)

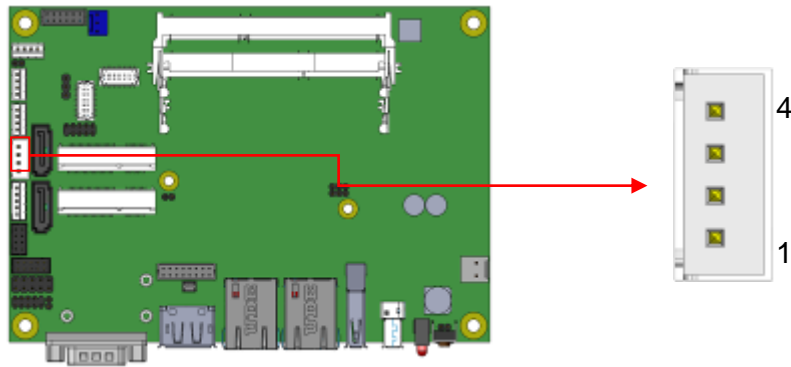

Pin #	Signal Name
1	+5V(1A)
2	Ground
3	Ground
4	+12V(1A)

J11: Smart Battery (JST B5B-PH-K-S)

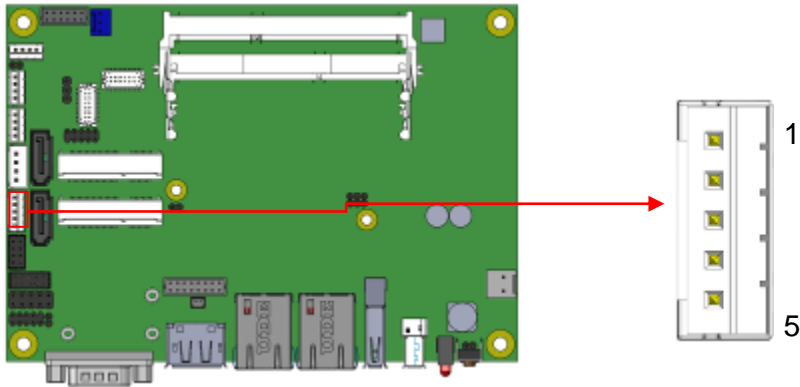

Pin #	Signal Name
1	RST#
2	ICHSWI#
3	Ground
4	SMB_DATA
5	SMB_CLK

J12: Mini PCIE Connector (share mSATA)

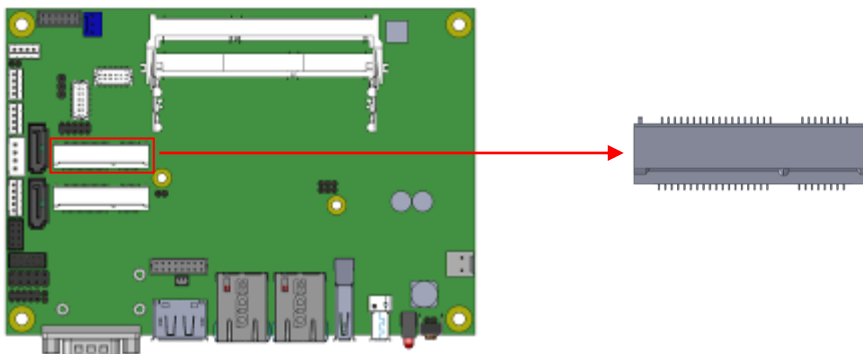

J13: Mini PCIE Connector (Half Size)

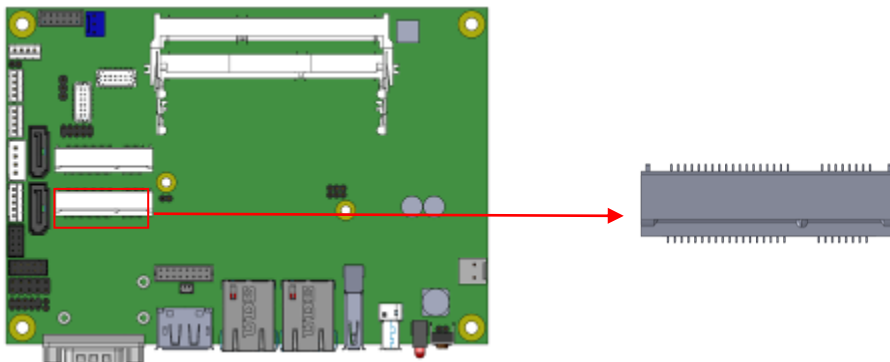

J14: USB 2.0 Connector (DF11-8DP-2DSA)

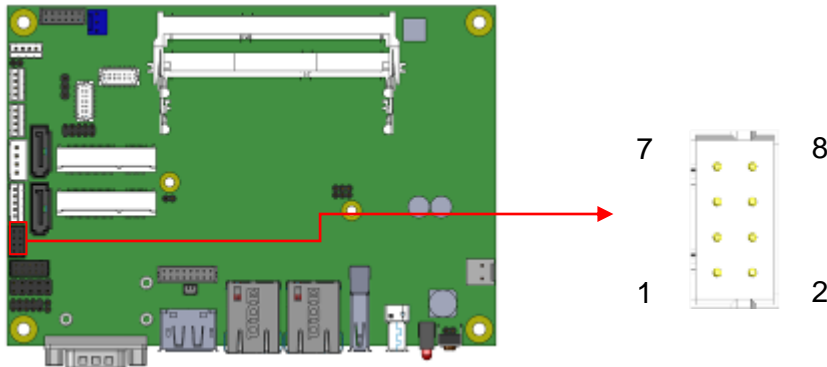

Signal Name	Pin #	Pin #	Signal Name
Vcc	1	2	Ground
D0-	3	4	D1+
D0+	5	6	D1-
Ground	7	8	Vcc

J15: COM2/RS232 Serial Port(DF11-10DP-2DSA)

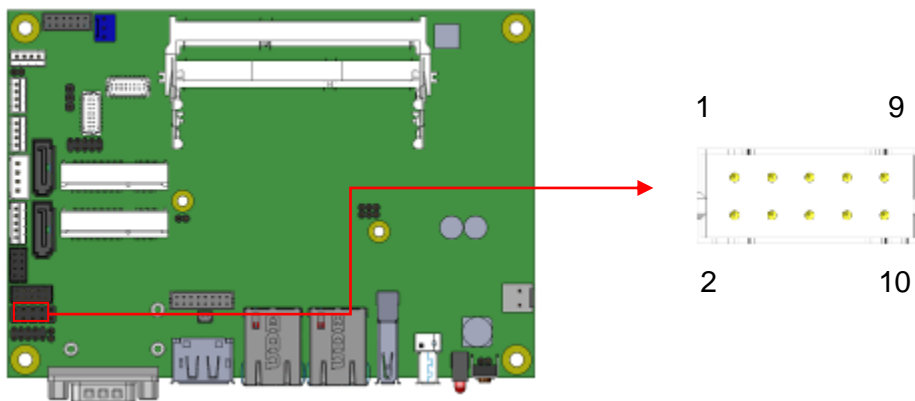

Signal Name	Pin #	Pin #	Signal Name
DCD, Data carrier detect	1	2	RXD, Receive data
TXD, Transmit data	3	4	Data terminal ready
GND, ground	5	6	DSR, Data set ready
RTS, Request to send	7	8	CTS, Clear to send
RI, Ring indicator	9	10	Not Used

J16: VGA Connector (DF11-16DP-2DSA)

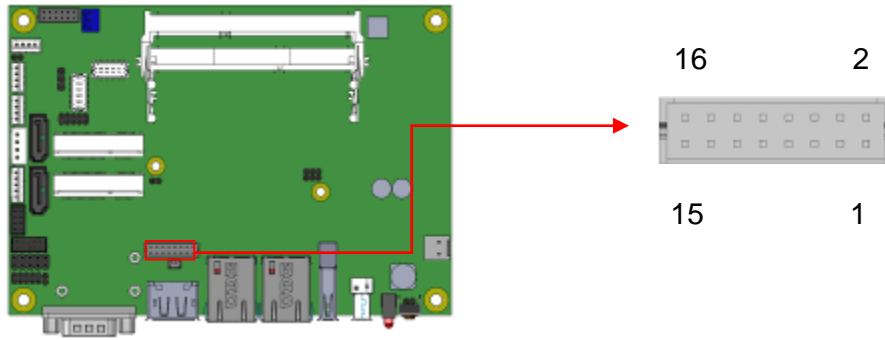

Signal Name	Pin #	Pin #	Signal Name
+5V	2	1	Red
Ground	4	3	Green
N.C	6	5	Blue
DDCDATA	8	7	N.C
H_SYNC	10	9	GND
V_SYNC	12	11	GND
DDCCLK	14	13	GND
N.C.	16	15	GND

J17: Digital I/O (signal level 5V) Connector (2.54mm)

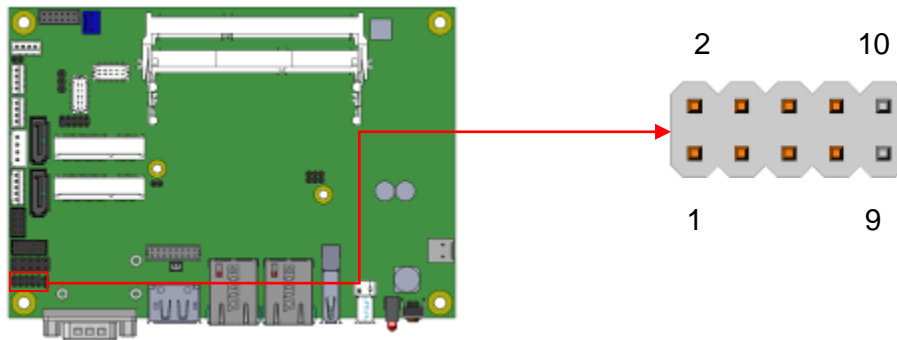

Signal Name	Pin #	Pin #	Signal Name
GND	1	2	VCC (500mA)
OUT3	3	4	OUT1
OUT2	5	6	OUT0
IN3	7	8	IN1
IN2	9	10	IN0

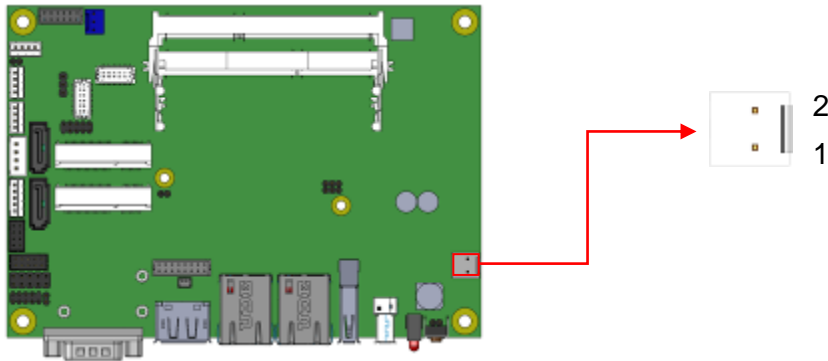
J18: Board Input Power Connector (HK_WAFER396-2S-WV)

Pin #	Signal Name
1	+9V to +30V(10A)
2	GND

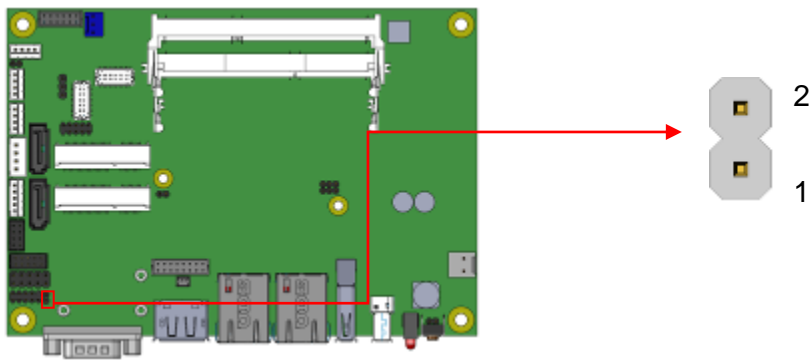
J19: Reset Switch (2mm)

Pin #	Signal Name
1	Reset Switch
2	Ground

J20: Power Switch (2mm)

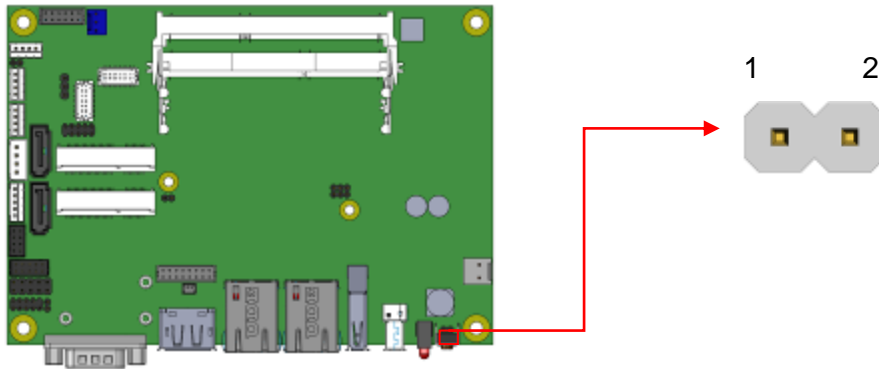

Pin #	Signal Name
1	Power Switch
2	Ground

JP3: LCD Backlight Connector (JST B4B-PH-K-S)

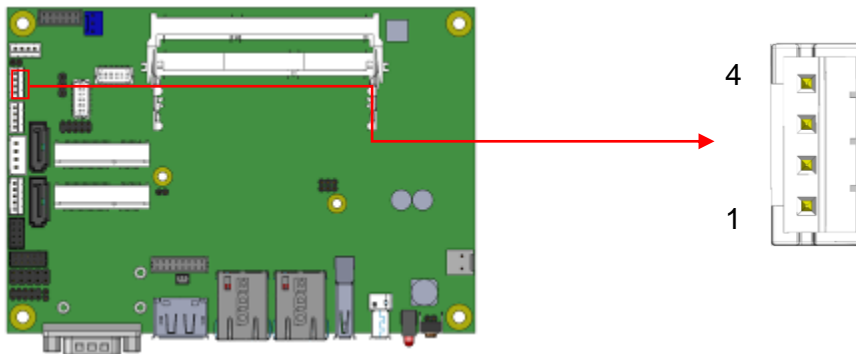

Pin #	Signal Name
1	+12V(1A)
2	Backlight Enable
3	Brightness Control
4	Ground

JP4: SPI Flash Connector (factory use only)

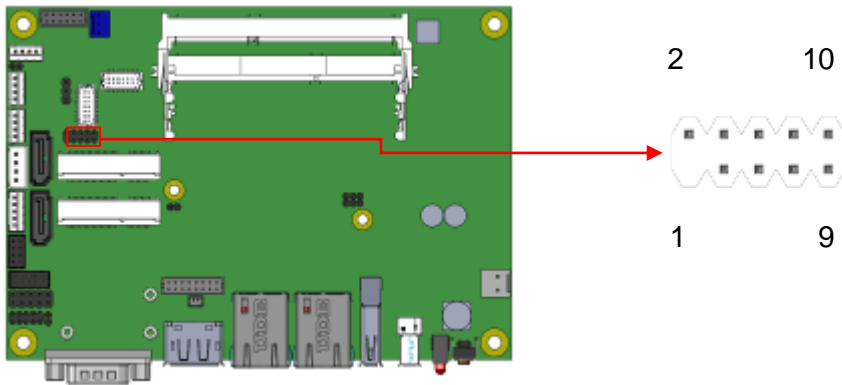

JP7: Factory use only

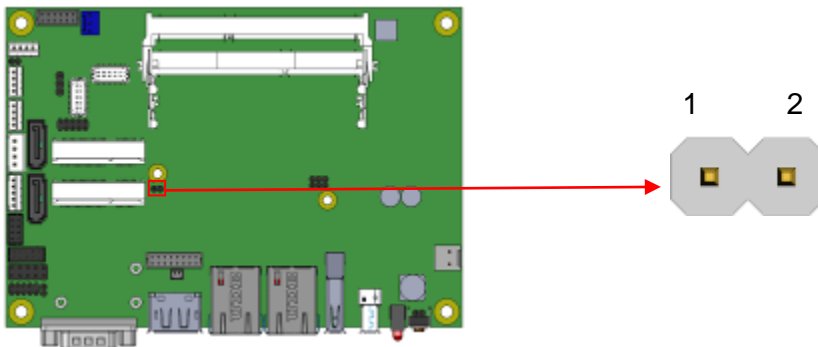

JP8: Debug 80 Port Connector (factory use only)

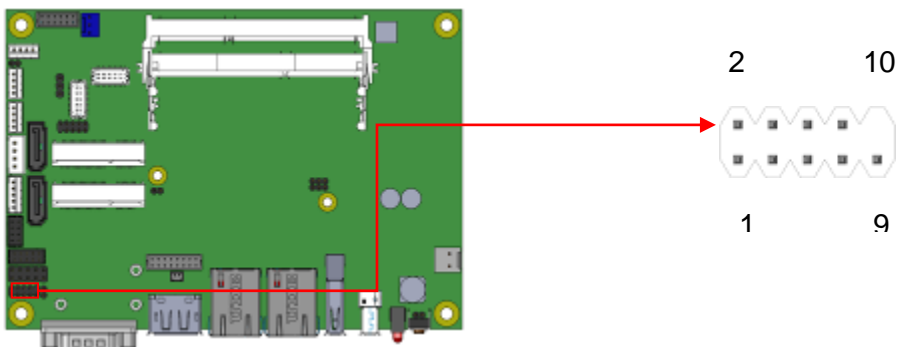

CHAPTER 3 BIOS SETUP

3.1 BIOS Introduction

The BIOS (Basic Input/Output System) installed in your computer system's ROM supports Intel processors. The BIOS provides critical low-level support for a standard device such as disk drives, serial ports and parallel ports. It also password protection as well as special support for detailed fine-tuning of the chipset controlling the entire system.

3.2 BIOS Setup

The BIOS provides a Setup utility program for specifying the system configurations and settings. The BIOS ROM of the system stores the Setup utility. When you turn on the computer, the BIOS is immediately activated. Pressing the key immediately allows you to enter the Setup utility. If you are a little bit late pressing the key, POST (Power On Self Test) will continue with its test routines, thus preventing you from invoking the Setup. If you still wish to enter Setup, restart the system by pressing the "Reset" button or simultaneously pressing the <Ctrl>, <Alt> and <Delete> keys. You can also restart by turning the system Off and back On again. The following message will appear on the screen:

```
Press <DEL> to Enter Setup
```

In general, you press the arrow keys to highlight items, <Enter> to select, the <PgUp> and <PgDn> keys to change entries, <F1> for help and <Esc> to quit.

When you enter the Setup utility, the Main Menu screen will appear on the screen. The Main Menu allows you to select from various setup functions and exit choices.

Warning: *It is strongly recommended that you avoid making any changes to the chipset defaults. These defaults have been carefully chosen by both AMI and your system manufacturer to provide the absolute maximum performance and reliability. Changing the defaults could cause the system to become unstable and crash in some cases.*

3.3 Main Settings

Aptio Setup Utility – Copyright © 2013 American Megatrends, Inc.

Main	Advanced	Chipset	Boot	Security	Save & Exit
BIOS Information					
System Language				[English]	→ ← Select Screen
System Date				[Tue 01/20/2009]	↑ ↓ Select Item
System Time				[21:52:06]	Enter: Select +- Change Field
Access Level				Administrator	F1: General Help F2: Previous Values F3: Optimized Default F4: Save ESC: Exit

System Language

Choose the system default language.

System Date

Set the Date. Use Tab to switch between Data elements.

System Time

Set the Time. Use Tab to switch between Data elements.

Advanced Settings

This section allows you to configure and improve your system and allows you to set up some system features according to your preference.

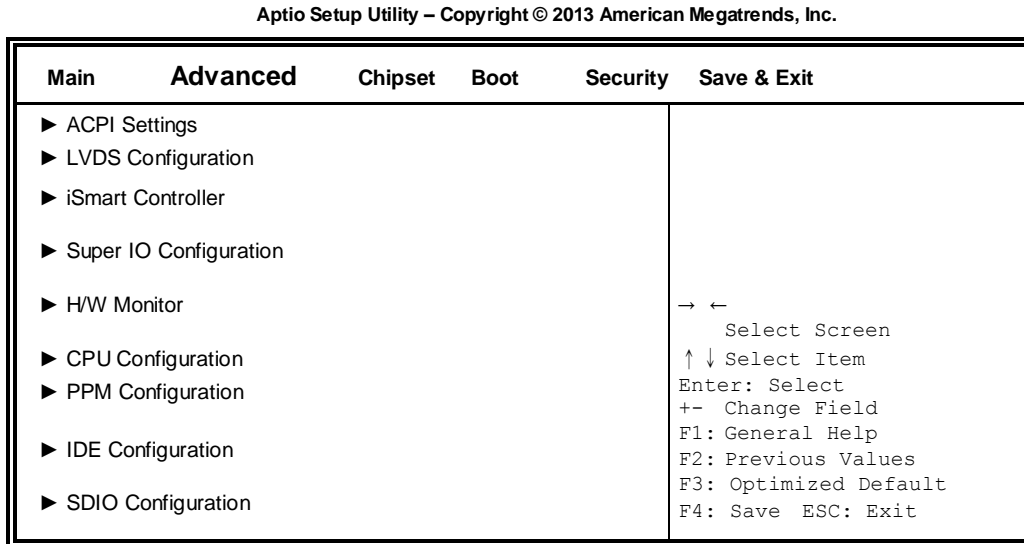

ACPI Settings

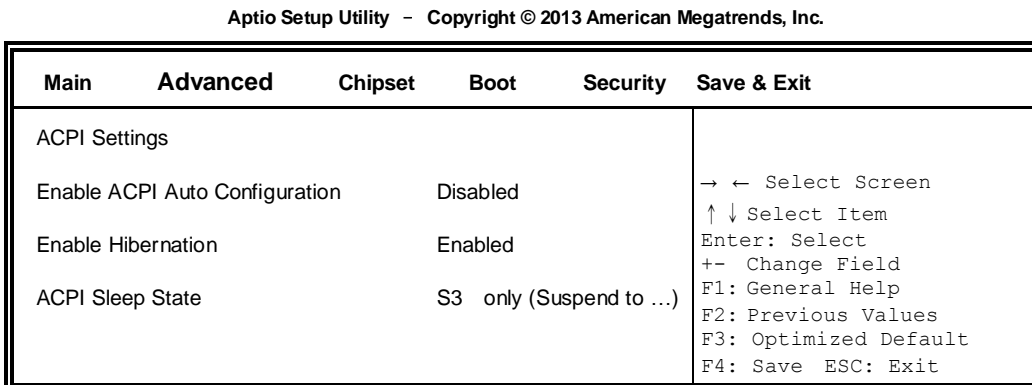

Enabled ACPI Auto Configuration

Enables or Disables BIOS ACPI Auto Configuration.

Enable Hibernation

Enables or Disables System ability to Hibernate (OS/S4 Sleep State). This option may be not effective with some OS.

ACPI Sleep State

Select ACPI sleep state the system will enter when the SUSPEND button is pressed.

LVDS Configuration

Aptio Setup Utility - Copyright © 2013 American Megatrends, Inc.

Main	Advanced	Chipset	Boot	Security	Save & Exit
Configuration					
	Panel Color Depth		24 BIT		→ ← Select Screen ↑ ↓ Select Item Enter: Select +- Change Field F1: General Help F2: Previous Values F3: Optimized Default F4: Save ESC: Exit
	LVDS Channel Type		Single		
	Panel Type		1024 x 768		
	LVDS Backlight Control		0(Min)		

iSmart Controller

Aptio Setup Utility - Copyright © 2013 American Megatrends, Inc.

Main	Advanced	Chipset	Boot	Security	Save & Exit
iSmart Controller					
	Power-On after Power failure		Disable		→ ← Select Screen ↑ ↓ Select Item Enter: Select +- Change Field F1: General Help F2: Previous Values F3: Optimized Default F4: Save ESC: Exit
	Schedule Slot 1		None		
	Schedule Slot 2		None		

Power-On after Power failure

This field sets the system power status whether *Disable* or *Enable* when power returns to the system from a power failure situation.

Schedule Slot 1 / 2

Setup the hour/minute for system power on.

Super IO Configuration

Aptio Setup Utility - Copyright © 2013 American Megatrends, Inc.

Main	Advanced	Chipset	Boot	Security	Save & Exit
Super IO Configuration					
▶ Serial Port 1 Configuration					
▶ Serial Port 2 Configuration					
					→ ← Select Screen ↑ ↓ Select Item Enter: Select +- Change Field F1: General Help F2: Previous Values F3: Optimized Default F4: Save ESC: Exit

Serial Port 1 Configuration

Set parameters of serial port 1(COMA)

Serial Port 2 Configuration

Set parameters of serial port 2(COMA)

H/W Monitor

Aptio Setup Utility - Copyright © 2013 American Megatrends, Inc.

Main	Advanced	Chipset	Boot	Security	Save & Exit
PC Health Status					
Smart Fan Function			Disabled		
SYS temp			+33.0 C		
CPU temp			+34.5 C		
FAN1 Speed			4066 RPM		
Vcore			+1.704 V		
+1.35V			+1.544 V		
AVCC			+3.360 V		
VSB3			+3.344 V		
VCC3V			+3.328 V		
CPU Shutdown Temperature			Disabled		

→ ← Select Screen
 ↑ ↓ Select Item
 Enter: Select
 +- Change Field
 F1: General Help
 F2: Previous Values
 F3: Optimized Default
 F4: Save ESC: Exit

Smart Fan Function

This field enables or disables the smart fan feature.

Disabled (default)

- 50 °C
- 60 °C
- 70 °C
- 80 °C
- 90 °C

Shutdown Temperature

This field enables or disables the Shutdown Temperature

Disabled (default)

- 70 °C/158 F
- 75 °C/167 F
- 80 °C/176 F
- 85 °C/185 F
- 90 °C/194 F
- 90 °C/203 F

Temperatures/Voltages

These fields are the parameters of the hardware monitoring function feature of the motherboard. The values are read-only values as monitored by the system and show the PC health status

CPU Configuration

This section shows the CPU configuration parameters.

Aptio Setup Utility - Copyright © 2013 American Megatrends, Inc.

Main	Advanced	Chipset	Boot	Security	Save & Exit
CPU Configuration					
▶ Socket 0 CPU Information					
CPU Speed			1751 Mhz		→ ← Select Screen ↑ ↓ Select Item Enter: Select +- Change Field F1: General Help F2: Previous Values F3: Optimized Default F4: Save ESC: Exit
64-bit			Supported		

Socket 0 CPU Information

Socket specific CPU Information.

CPU PPM Configuration

Aptio Setup Utility - Copyright © 2013 American Megatrends, Inc.

Main	Advanced	Chipset	Boot	Security	Save & Exit
CPU PPM Configuration					
EIST			Enabled		→ ← Select Screen ↑ ↓ Select Item Enter: Select +- Change Field F1: General Help F2: Previous Values F3: Optimized Default F4: Save ESC: Exit

EIST

Enable/Disable Intel SpeedStep.

IDE Configuration

SATA Devices Configuration.

Aptio Setup Utility - Copyright © 2013 American Megatrends, Inc.

Main	Advanced	Chipset	Boot	Security	Save & Exit
IDE Configuration					
Serial-ATA (SATA)				Enabled	
SATA Mode				AHCI	
Serial-ATA Port 0				Enabled	
SATA Port0 HotPlug				Disabled	
Serial-ATA Port 1				Enabled	
SATA Port1 HotPlug				Disabled	
SATA Port0				Not Present	
SATA Port1				Not Present	
				→ ← Select Screen ↑ ↓ Select Item Enter: Select +- Change Field F1: General Help F2: Previous Values F3: Optimized Default F4: Save ESC: Exit	

Serial-ATA(SATA)

Enabled / Disabled Serial ATA

SATA Mode

Select IDE / AHCI Mode

Serial-ATA Port 0

Enabled / Disabled Serial Port 0

SATA Port0 HotPlug

Enabled / Disabled SATA Port 0 HotPlug

Serial-ATA Port 1

Enabled / Disabled Serial Port 1

SATA Port1 HotPlug

Enabled / Disabled SATA Port 1 HotPlug

SDIO Configuration

Aptio Setup Utility - Copyright © 2013 American Megatrends, Inc.

Main	Advanced	Chipset	Boot	Security	Save & Exit
SDIO Access Mode				Auto	→ ← Select Screen ↑ ↓ Select Item Enter: Select +- Change Field F1: General Help F2: Previous Values F3: Optimized Default F4: Save ESC: Exit

SDIO Access Mode

Auto Option: Access SD device in DMA mode if controller supports it. Otherwise, in PIO mode. DMA options: Access SD device in DMA mode. PIO Option: Access PIO device in DMA

Chipset Settings

Aptio Setup Utility - Copyright © 2013 American Megatrends, Inc.

Main	Advanced	Chipset	Boot	Security	Save & Exit
▶ North Bridge					→ ← Select Screen ↑ ↓ Select Item Enter: Select +- Change Field F1: General Help F2: Previous Values F3: Optimized Default F4: Save ESC: Exit

North Bridge

Aptio Setup Utility - Copyright © 2013 American Megatrends, Inc.

Main	Advanced	Chipset	Boot	Security	Save & Exit
Memory Information					→ ← Select Screen ↑ ↓ Select Item Enter: Select +- Change Field F1: General Help F2: Previous Values F3: Optimized Default F4: Save ESC: Exit
Total Memory		4096 MB (LPDDR3)			
Memory Slot0		4096 MB (LPDDR3)			
Memory Slot2		Not Present			

3.4 Security Settings

This section allows you to configure and improve your system and allows you to set up some system features according to your preference.

Aptio Setup Utility - Copyright © 2013 American Megatrends, Inc.

Main	Advanced	Chipset	Boot	Security	Save & Exit
Password Description If ONLY the Administrator's password is set, then this only limit access to Setup and is only asked for when entering Setup. If ONLY the User's password is set, then this is a power on password and must be entered to boot or enter Setup. In Setup the User will have Administrator rights The password length must be in the following range:					
Minimum length					3
Maximum length					20
Administrator Password					
User Password					
					→ ← Select Screen ↑ ↓ Select Item Enter: Select +- Change Field F1: General Help F2: Previous Values F3: Optimized Default F4: Save ESC: Exit

Administrator Password

Set Administrator Password.

Boot Settings

This section allows you to configure the boot settings.

Aptio Setup Utility - Copyright © 2013 American Megatrends, Inc.

Main	Advanced	Chipset	Boot	Security	Save & Exit
Boot Configuration					
Setup Prompt Timeout			1		
Bootup NumLock State			On		
Quiet Boot			Disabled		
Fast Boot			Disabled	→ ← Select Screen	
Boot Option Priorities				↑ ↓ Select Item	
Boot Option #1			UEFI:Built-in EFI	Enter: Select	
				+- Change Field	
				F1: General Help	
				F2: Previous Values	
				F3: Optimized Default	
				F4: Save ESC: Exit	

Setup Prompt Timeout

Number of seconds to wait for setup activation key.

65535(0xFFFF) means indefinite waiting.

Bootup NumLock State

Select the keyboard NumLock state.

Quiet Boot

Enables or disables Quiet Boot option.

Fast Boot

Enables or disables boot with initialization of a minimal set of devices required to launch active boot option. Has no effect for BBS boot options.

Boot Option Priorities

Sets the system boot order.

Save & Exit Settings

Aptio Setup Utility - Copyright © 2013 American Megatrends, Inc.

Main	Advanced Chipset	Boot	Security	Save & Exit
Save Changes and Exit				
Discard Changes and Exit				
Save Changes and Reset				
Discard Changes and Reset				
Save Options				
Save Changes				
Discard Changes				
Restore Defaults				
Save as User Defaults				
Restore User Defaults				
Boot Override				
				→ ← Select Screen ↑ ↓ Select Item Enter: Select +- Change Field F1: General Help F2: Previous Values F3: Optimized Default F4: Save ESC: Exit

Save Changes and Exit

Exit system setup after saving the changes.

Discard Changes and Exit

Exit system setup without saving any changes.

Save Changes and Reset

Reset the system after saving the changes.

Discard Changes and Reset

Reset system setup without saving any changes.

Save Changes

Save Changes done so far to any of the setup options.

Discard Changes

Discard Changes done so far to any of the setup options.

Restore Defaults

Restore/Load Defaults values for all the setup options.

Save as User Defaults

Save the changes done so far as User Defaults.

Restore User Defaults

Restore the User Defaults to all the setup options.

CHAPTER 4 DRIVERS INSTALLATION

IMPORTANT NOTE:

After installing your Windows operating system, you must install first the Intel Chipset Software Installation Utility before proceeding with the drivers installation.

4.1 Intel Chipset Software Installation Utility

The Intel Chipset Drivers should be installed first before the software drivers to enable Plug & Play INF support for Intel chipset components. Follow the instructions.

1. Insert the DVD that comes with the system. Click **System** and then **BYTEM-xx1/xx2/xx3 Series**

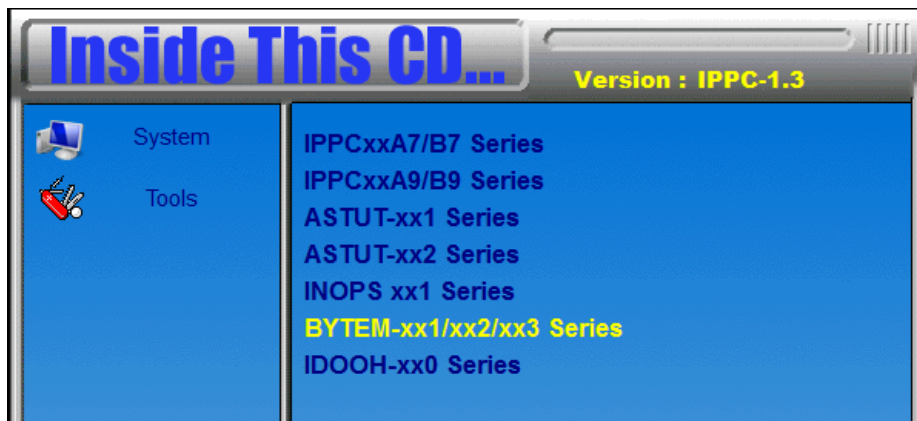

2. Click **Intel(R) Chipset Software Installation Utility**.



3. When the Welcome screen to the Intel® Chipset Device Software appears, click **Next** to continue.
4. Click **Yes** to accept the software license agreement and proceed with the installation process.
5. The Setup process is now complete. Click **Finish** to restart the computer and for changes to take effect.

4.2 VGA Drivers Installation

1. Insert the DVD that comes with the system. Click **Intel(R) Baytrail Chipset. Driver**



2. When the Welcome screen appears, click **Next** to continue.
3. Click **Yes** to accept the license agreement and continue the installation.
4. Setup complete. Click **Finish** to restart the computer and for changes to take effect.



4.3 Realtek High Definition Audio Driver Installation

1. Insert the DVD that comes with the system. Click **Intel** and then **Intel(R) Baytrail Chipset**. Click **Realtek High Definition Audio Driver**.



2. On the Welcome screen, click **Next** to proceed with the installation.

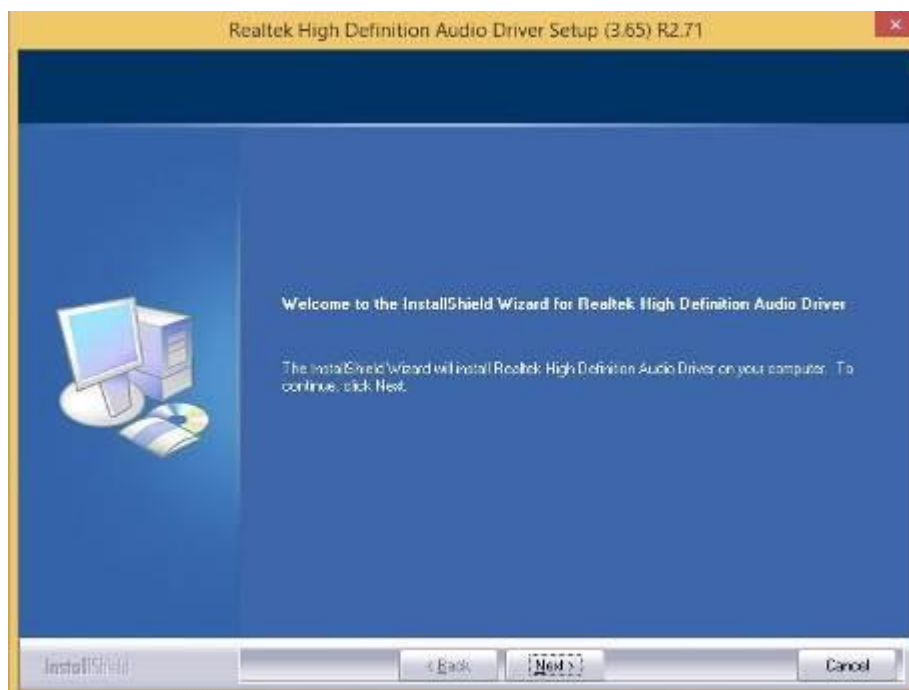

3. InstallShield Wizard is complete. Click **Finish** to restart the computer and for changes to take effect.

4.4 I21x Gigabit Network Drivers Installation

1. Insert the DVD that comes with the system. Click **Intel(R) I21x Gigabit Network Driver**.



2. On the Welcome screen, click **Next** to proceed with the installation.

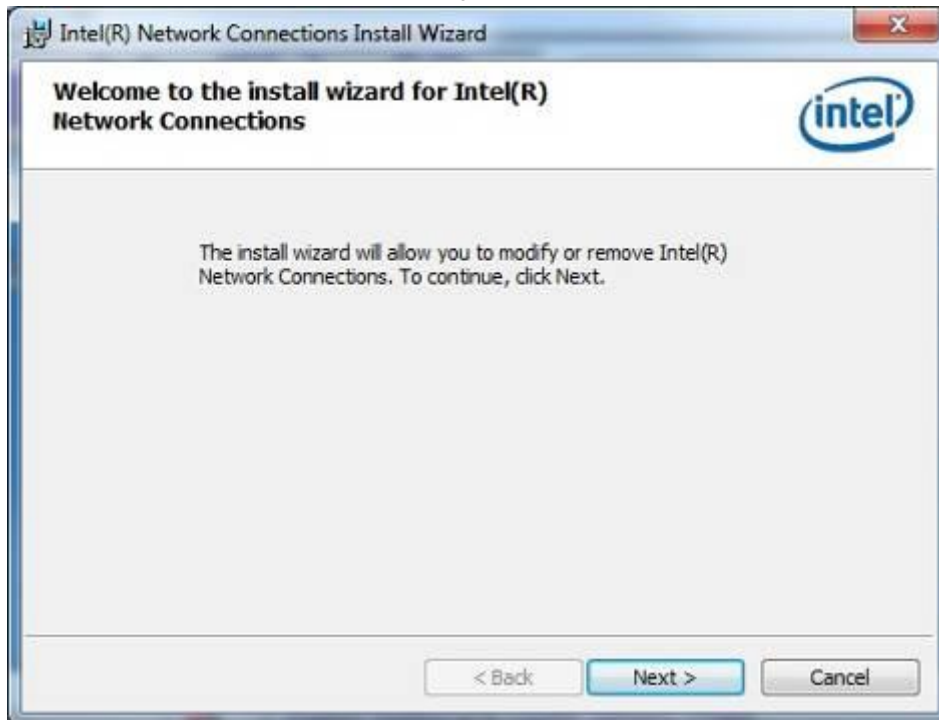

3. Click **Next** to accept the license agreement.



4. Click **Next** to accept the setup options.

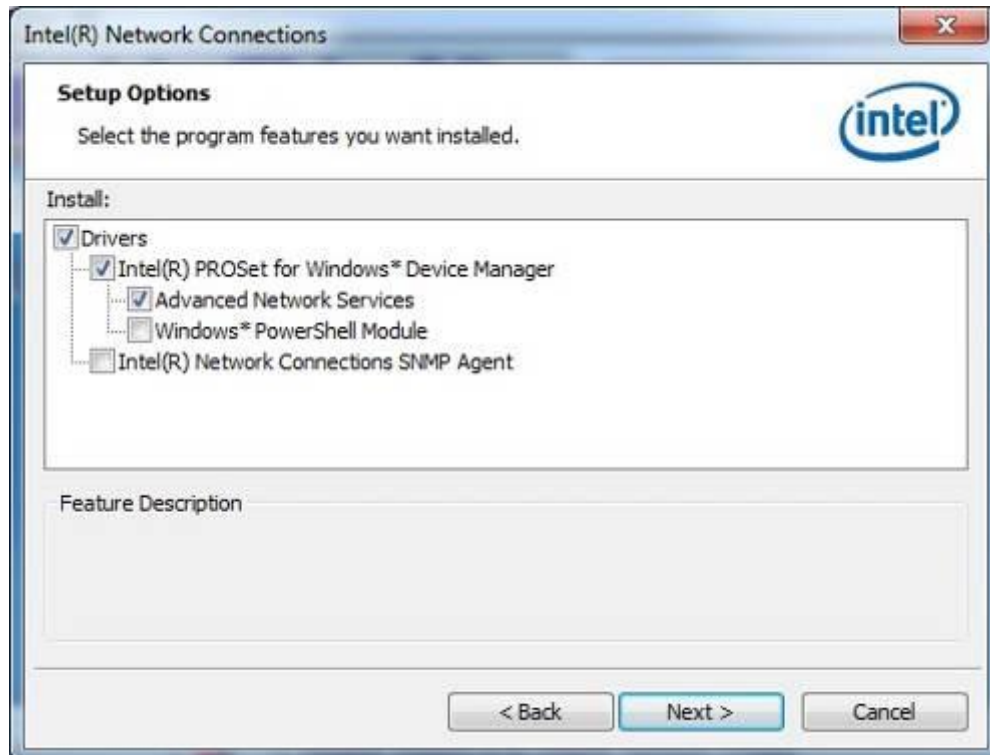

5. Click **Install** ready to install the program.

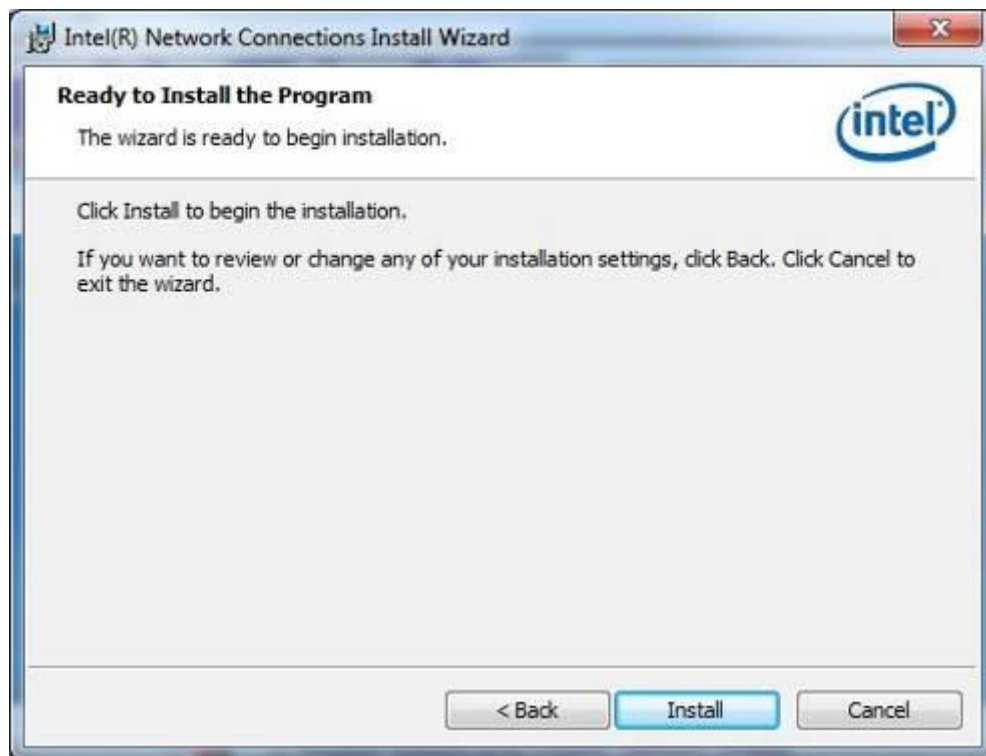

6. Install Wizard is complete. Click **Finish** to restart the computer and for changes to take effect.

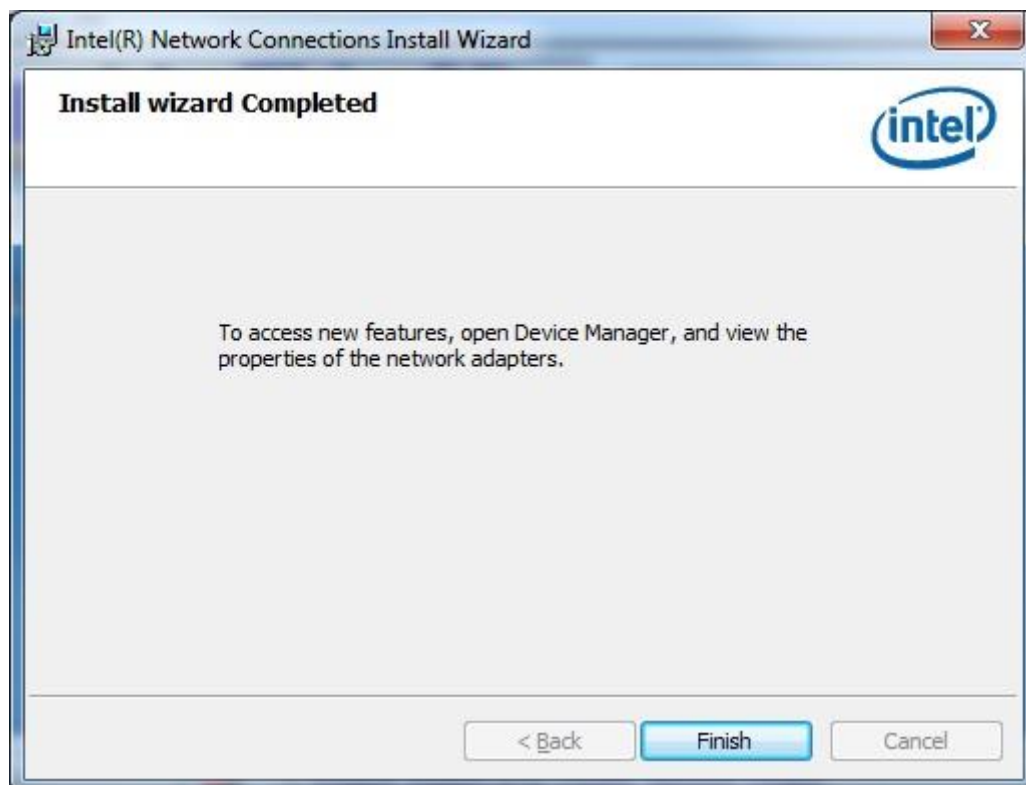

4.5 Intel Trusted Execution Engine Installation

Note :Windows 7 OS only

Important Notes

4) Intel TXE PV Firmware is signed by Intel

- PV POR configuration is signed Intel TXE FW and Production Silicon
- Signed Intel TXE FW and Pre Production Silicon is supported for development needs only

Combination of unsigned Intel TXE Firmware and Production Silicon is not supported and will result in unexpected behavior

5) For Windows 7 OS only:

Intel® Trusted Execution Engine Interface (Intel® TXEI) Driver uses KMDF (WDF) 1.11, which is built-in on Windows 8 and Windows 8.1. However, Windows 7 doesn't have it. Please install Kernel-Mode Driver Framework (KMDF) version 1.1. Otherwise, yellow bang appears on Intel TXEI device upon installation. Please follow instructions in this [link: KB2685811](#)

Driver names and brands may be claimed as the property of others.

All products, computer systems, dates and figures specified are preliminary based on current expectations, and are subject to change without notice.

Intel Confidential



1. Insert the DVD that comes with the board. Click **Intel(R) TXE Driver**.



2. On the Setup Welcome screen, click **Next** to proceed with the installation process.

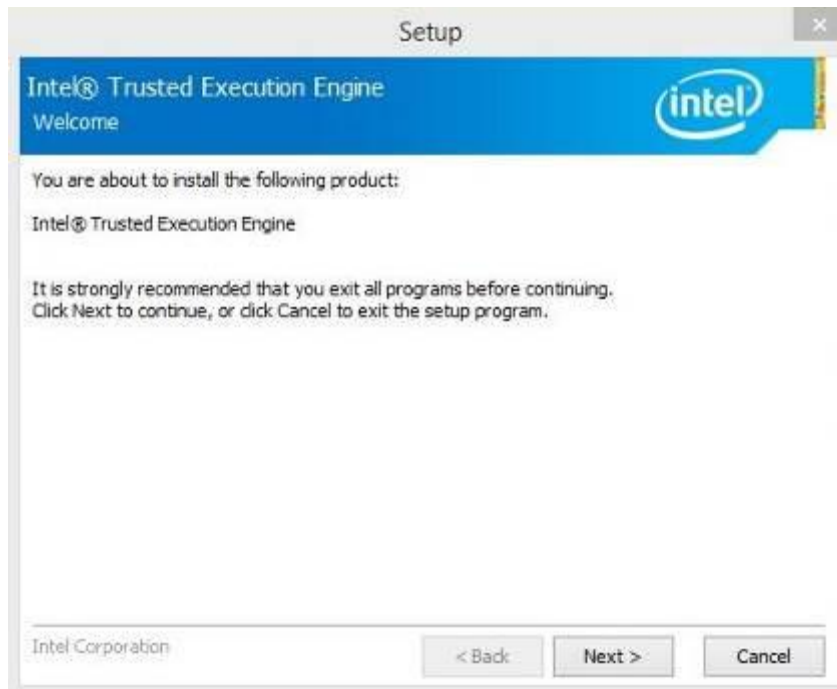

3. Click **Next** to accept the license agreement.
4. Installation of the Intel Trusted Execution Engine is now complete. Click **Finish**.

4.6 Intel USB 3.0 Drivers Installation

1. Insert the DVD that comes with the system. Click **Intel(R) USB 3.0 Driver**.



2. On the Welcome screen, click **Next** to proceed.



3. Click **Yes** to accept the license agreement.



4. Click **Next** to accept the setup progress.

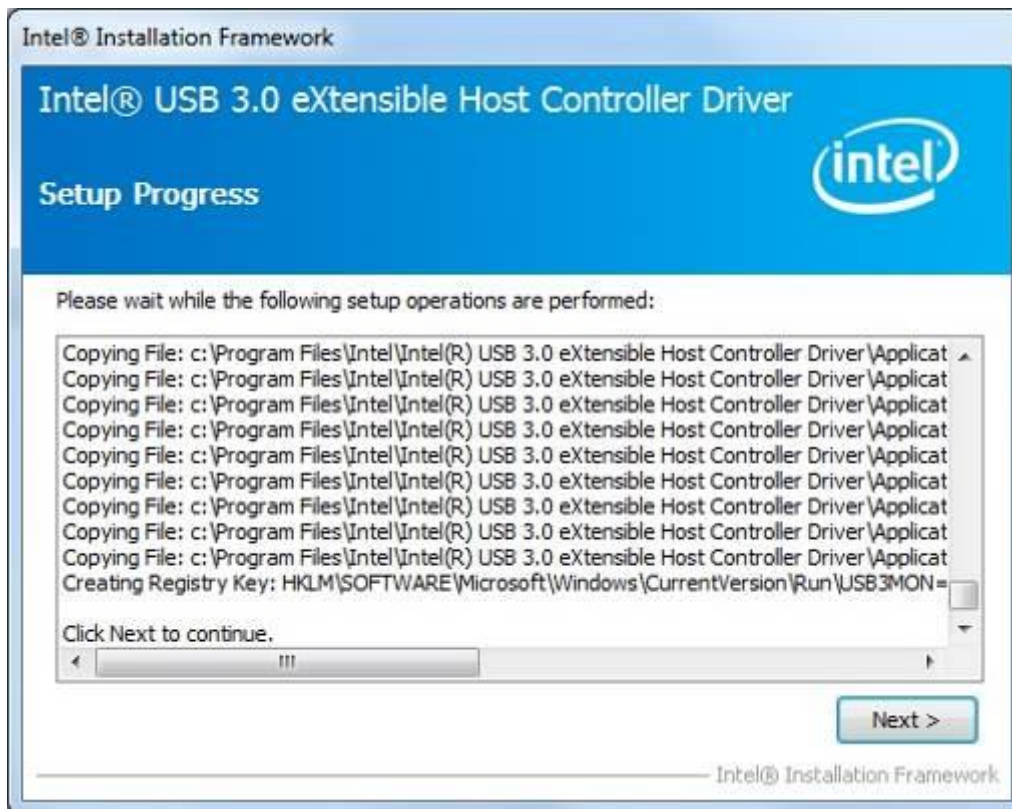

5. Setup is complete. Click **Finish** to restart the computer and for changes to take effect.



Appendix

A. I/O Port Address Map

Each peripheral device in the system is assigned a set of I/O port addresses which also becomes the identity of the device. The following table lists the I/O port addresses used.

Address	Device Description
0000h-001Fh	Direct memory access controller
0000h-001Fh	PCI bus
0040h-0043h	System timer
0050h-0053h	System timer
0070h-0077h	System CMOS/real time clock
0081h-0091h	Direct memory access controller
0093h-009Fh	Direct memory access controller
00C0h-00DFh	Direct memory access controller
00F0h-00F0h	Numeric data processor
02F8h-02FFh	Communications Port (COM2)
03B0h-03BBh	Intel(R) HD Graphics 4600
03C0h-03DFh	Intel(R) HD Graphics 4600
03F8h-03FFh	Communications Port (COM1)
0D00h-FFFFh	PCI bus
E000h-EFFFh	Intel(R) 8 Series/C220 Series PCI Express Root Port #7 - 8C1C
F000h-F03Fh	Intel(R) HD Graphics 4600
F040h-F05Fh	Intel(R) 8 Series/C220 Series SMBus Controller - 8C22
F060h-F07Fh	Intel(R) 8 Series/C220 Series SATA AHCI Controller - 8C02
F0A0h-F0A3h	Intel(R) 8 Series/C220 Series SATA AHCI Controller - 8C02
F0B0h-F0B7h	Intel(R) 8 Series/C220 Series SATA AHCI Controller - 8C02
F0C0h-F0C3h	Intel(R) 8 Series/C220 Series SATA AHCI Controller - 8C02
F0D0h-F0D7h	Intel(R) 8 Series/C220 Series SATA AHCI Controller - 8C02
F0E0h-F0E7h	Intel(R) Active Management Technology - SOL (COM3)

B. Interrupt Request Lines (IRQ)

Peripheral devices use interrupt request lines to notify CPU for the service required. The following table shows the IRQ used by the devices on board.

Level	Function
IRQ0	System Timer
IRQ3	Serial Port #2
IRQ4	Serial Port #1
IRQ 10	Intel(R) 8 Series/C220 Series SMBus Controller - 8C22
IRQ 13	Numeric data processor
IRQ 16	High Definition Audio Controller
IRQ 16	Intel(R) 8 Series/C220 Series USB EHCI #2 - 8C2D
IRQ 16	Intel(R) Management Engine Interface
IRQ 19	Intel(R) 8 Series/C220 Series SATA AHCI Controller - 8C02
IRQ 19	Intel(R) Active Management Technology - SOL (COM3)
IRQ 22	High Definition Audio Controller
IRQ 23	Intel(R) 8 Series/C220 Series USB EHCI #1 - 8C26

C. Digital I/O Sample Code

File of the NCT5523D.H

```
//-----
// THIS CODE AND INFORMATION IS PROVIDED "AS IS" WITHOUT WARRANTY OF ANY
// KIND, EITHER EXPRESSED OR IMPLIED, INCLUDING BUT NOT LIMITED TO THE
// IMPLIED WARRANTIES OF MERCHANTABILITY AND/OR FITNESS FOR A PARTICULAR
// PURPOSE.
//-----

#ifndef __NCT5523D_H
#define __NCT5523D_H                                1

//-----

#define NCT5523D_INDEX_PORT                        (NCT5523D_BASE)
#define NCT5523D_DATA_PORT                        (NCT5523D_BASE+1)

//-----

#define NCT5523D_REG_LD                          0x07

//-----

#define NCT5523D_UNLOCK                          0x87
#define NCT5523D_LOCK                            0xAA

//-----

unsigned int Init_NCT5523D(void);
void Set_NCT5523D_LD( unsigned char);
void Set_NCT5523D_Reg( unsigned char, unsigned char);
unsigned char Get_NCT5523D_Reg( unsigned char);

//-----

---

#endif    //__NCT5523D_H
```

File of the MAIN.CPP

```
//-----
// THIS CODE AND INFORMATION IS PROVIDED "AS IS" WITHOUT WARRANTY OF ANY
// KIND, EITHER EXPRESSED OR IMPLIED, INCLUDING BUT NOT LIMITED TO THE
// IMPLIED WARRANTIES OF MERCHANTABILITY AND/OR FITNESS FOR A PARTICULAR
// PURPOSE.
//-----
#include <dos.h>
#include <conio.h>
#include <stdio.h>
#include <stdlib.h>
#include "NCT5523D.H"
//-----

int main (void);

void Dio5Initial(void);
void Dio5SetOutput(unsigned char);
unsigned char Dio5GetInput(void);
void Dio5SetDirection(unsigned char);
unsigned char Dio5GetDirection(void);
//-----

int main (void)
{
    char SIO;

    SIO = Init_NCT5523D();
    if (SIO == 0)
    {
        printf("Can not detect Nuvoton NCT5523D, program abort.\n");
        return(1);
    }

    Dio5Initial();

    //for GPIO20..27
    Dio5SetDirection(0x0F); //GP20..23 = input, GP24..27=output
    printf("Current DIO direction = 0x%X\n", Dio5GetDirection());
}
```

```
printf("Current DIO status = 0x%X\n", Dio5GetInput());
```

```
printf("Set DIO output to high\n");
```

```
Dio5SetOutput(0x0F);
```

```
printf("Set DIO output to low\n");
```

```
Dio5SetOutput(0x00);
```

```
return 0;
```

```
}
```

```
//-----
```

```

void Dio5Initial(void)
{
    unsigned char ucBuf;

    ucBuf = Get_NCT5523D_Reg(0x1C);
    ucBuf &= ~0x02;
    Set_NCT5523D_Reg(0x1C, ucBuf);

    Set_NCT5523D_LD(0x07);
    //switch to logic device 7                //enable the GP2 group
    ucBuf = Get_NCT5523D_Reg(0x30);
    ucBuf |= 0x04;
    Set_NCT5523D_Reg(0x30, ucBuf);
}
//-----
void Dio5SetOutput(unsigned char NewData)
{
    Set_NCT5523D_LD(0x07);                //switch to logic device 7
    Set_NCT5523D_Reg(0xE1, NewData);
}
//-----
unsigned char Dio5GetInput(void)
{
    unsigned char result;

    Set_NCT5523D_LD(0x07);                //switch to logic device 7
    result = Get_NCT5523D_Reg(0xE1);
    return (result);
}
//-----
void Dio5SetDirection(unsigned char NewData)
{
    //NewData : 1 for input, 0 for output
    Set_NCT5523D_LD(0x07);                //switch to logic device 7
    Set_NCT5523D_Reg(0xE8, NewData);
}
//-----
unsigned char Dio5GetDirection(void)

```

```
{
    unsigned char result;

    Set_NCT5523D_LD(0x07);                //switch to logic device 7
    result = Get_NCT5523D_Reg(0xE8);
    return (result);
}
//-----
```

```

File of the NCT5523D.CPP
//-----
// THIS CODE AND INFORMATION IS PROVIDED "AS IS" WITHOUT WARRANTY OF ANY
// KIND, EITHER EXPRESSED OR IMPLIED, INCLUDING BUT NOT LIMITED TO THE
// IMPLIED WARRANTIES OF MERCHANTABILITY AND/OR FITNESS FOR A PARTICULAR
// PURPOSE.
//-----
#include "NCT5523D.H"
#include <dos.h>
//-----
unsigned int NCT5523D_BASE;
void Unlock_NCT5523D (void);
void Lock_NCT5523D (void);
//-----
unsigned int Init_NCT5523D(void)
{
    unsigned int result;
    unsigned char ucDid;

    NCT5523D_BASE = 0x4E;
    result = NCT5523D_BASE;

    ucDid = Get_NCT5523D_Reg(0x20);
    if (ucDid == 0xC4) //NCT5523D??
    { goto Init_Finish; }

    NCT5523D_BASE = 0x2E;
    result = NCT5523D_BASE;

    ucDid = Get_NCT5523D_Reg(0x20);
    if (ucDid == 0xC4) //NCT5523D??
    { goto Init_Finish; }

    NCT5523D_BASE = 0x00;
    result = NCT5523D_BASE;

Init_Finish:
    return (result);
}

```

```
}  
//-----  
void Unlock_NCT5523D (void)  
{  
    outportb(NCT5523D_INDEX_PORT, NCT5523D_UNLOCK);  
    outportb(NCT5523D_INDEX_PORT, NCT5523D_UNLOCK);  
}  
//-----  
void Lock_NCT5523D (void)  
{  
    outportb(NCT5523D_INDEX_PORT, NCT5523D_LOCK);  
}  
//-----
```

```

void Set_NCT5523D_LD( unsigned char LD)
{
    Unlock_NCT5523D();
    outportb(NCT5523D_INDEX_PORT, NCT5523D_REG_LD);
    outportb(NCT5523D_DATA_PORT, LD);
    Lock_NCT5523D();
}
//-----

void Set_NCT5523D_Reg( unsigned char REG, unsigned char DATA)
{
    Unlock_NCT5523D();
    outportb(NCT5523D_INDEX_PORT, REG);
    outportb(NCT5523D_DATA_PORT, DATA);
    Lock_NCT5523D();
}
//-----

unsigned char Get_NCT5523D_Reg(unsigned char REG)
{
    unsigned char Result;
    Unlock_NCT5523D();
    outportb(NCT5523D_INDEX_PORT, REG);
    Result = inportb(NCT5523D_DATA_PORT);
    Lock_NCT5523D();
    return Result;
}
//-----

```

D. Watchdog Timer Configuration

The WDT is used to generate a variety of output signals after a user programmable count. The WDT is suitable for use in the prevention of system lock-up, such as when software becomes trapped in a deadlock. Under these sorts of circumstances, the timer will count to zero and the selected outputs will be driven. Under normal circumstance, the user will restart the WDT at regular intervals before the timer counts to zero.

SAMPLE CODE:

File of the NCT5523D.H

```
//-----
//
// THIS CODE AND INFORMATION IS PROVIDED "AS IS" WITHOUT WARRANTY OF ANY
// KIND, EITHER EXPRESSED OR IMPLIED, INCLUDING BUT NOT LIMITED TO THE
// IMPLIED WARRANTIES OF MERCHANTABILITY AND/OR FITNESS FOR A PARTICULAR
// PURPOSE.
//
//-----
#ifndef __NCT5523D_H
#define __NCT5523D_H                1
//-----
#define  NCT5523D_INDEX_PORT      (NCT5523D_BASE)
#define  NCT5523D_DATA_PORT      (NCT5523D_BASE+1)
//-----
#define  NCT5523D_REG_LD          0x07
//-----
#define NCT5523D_UNLOCK          0x87
#define NCT5523D_LOCK            0xAA
//-----
unsigned int Init_NCT5523D(void);
void Set_NCT5523D_LD( unsigned char);
void Set_NCT5523D_Reg( unsigned char, unsigned char);
unsigned char Get_NCT5523D_Reg( unsigned char);
//-----
#endif  //__NCT5523D_H
```

File of the MAIN.CPP.

```
//-----
//
// THIS CODE AND INFORMATION IS PROVIDED "AS IS" WITHOUT WARRANTY OF ANY
// KIND, EITHER EXPRESSED OR IMPLIED, INCLUDING BUT NOT LIMITED TO THE
// IMPLIED WARRANTIES OF MERCHANTABILITY AND/OR FITNESS FOR A PARTICULAR
// PURPOSE.
//
//-----
#include <dos.h>
#include <conio.h>
#include <stdio.h>
#include <stdlib.h>
#include "NCT5523D.H"
//-----
int main (void);

void WDTInitial(void);
void WDTEnable(unsigned char);
void WDTDisable(void);

//-----
int main (void)
{
    char SIO;

    SIO = Init_NCT5523D();
    if (SIO == 0)
    {
        printf("Can not detect Nuvoton NCT5523D, program abort.\n");
        return(1);
    }

    WDTInitial();
    WDTEnable(10);
    WDTDisable();
    return 0;
}
```

```
}
//-----
void WDTInitial(void)
{
    unsigned char bBuf;
    Set_NCT5523D_LD(0x08);           //switch to logic device 8
    bBuf = Get_NCT5523D_Reg(0x30);
    bBuf &= (~0x01);
    Set_NCT5523D_Reg(0x30, bBuf);    //Enable WDTO
}
//-----

void WDTEnable(unsigned char NewInterval)
{
    unsigned char bBuf;

    Set_NCT5523D_LD(0x08);           //switch to logic device 8
    Set_NCT5523D_Reg(0x30, 0x01);    //enable timer
    bBuf = Get_NCT5523D_Reg(0xF0);
    bBuf &= (~0x08);
    Set_NCT5523D_Reg(0xF0, bBuf);    //count mode is second

    Set_NCT5523D_Reg(0xF1, NewInterval); //set timer
}
//-----
void WDTDisable(void)
{
    Set_NCT5523D_LD(0x08);           //switch to logic device 8
    Set_NCT5523D_Reg(0xF1, 0x00);    //clear watchdog timer
    Set_NCT5523D_Reg(0x30, 0x00);    //watchdog disabled
}
//-----
```

```

File of the NCT5523D.CPP
//-----
//
// THIS CODE AND INFORMATION IS PROVIDED "AS IS" WITHOUT WARRANTY OF ANY
// KIND, EITHER EXPRESSED OR IMPLIED, INCLUDING BUT NOT LIMITED TO THE
// IMPLIED WARRANTIES OF MERCHANTABILITY AND/OR FITNESS FOR A PARTICULAR
// PURPOSE.
//
//-----
#include "NCT5523D.H"
#include <dos.h>
//-----
unsigned int NCT5523D_BASE;
void Unlock_NCT5523D (void);
void Lock_NCT5523D (void);
//-----
unsigned int Init_NCT5523D(void)
{
    unsigned int result;
    unsigned char ucDid;

    NCT5523D_BASE = 0x4E;
    result = NCT5523D_BASE;
    ucDid = Get_NCT5523D_Reg(0x20);
    if (ucDid == 0xC4) //NCT5523D??
    { goto Init_Finish; }

    NCT5523D_BASE = 0x2E;
    result = NCT5523D_BASE;
    ucDid = Get_NCT5523D_Reg(0x20);
    if (ucDid == 0xC4) //NCT5523D??
    { goto Init_Finish; }

    NCT5523D_BASE = 0x00;
    result = NCT5523D_BASE;

    Init_Finish:

```

```
    return (result);
}
//-----
void Unlock_NCT5523D (void)
{
    outportb(NCT5523D_INDEX_PORT, NCT5523D_UNLOCK);
    outportb(NCT5523D_INDEX_PORT, NCT5523D_UNLOCK);
}
//-----
void Lock_NCT5523D (void)
{
    outportb(NCT5523D_INDEX_PORT, NCT5523D_LOCK);
}
//-----
```

```

void Set_NCT5523D_LD( unsigned char LD)
{
    Unlock_NCT5523D();
    outportb(NCT5523D_INDEX_PORT, NCT5523D_REG_LD);
    outportb(NCT5523D_DATA_PORT, LD);
    Lock_NCT5523D();
}
//-----

void Set_NCT5523D_Reg( unsigned char REG, unsigned char DATA)
{
    Unlock_NCT5523D();
    outportb(NCT5523D_INDEX_PORT, REG);
    outportb(NCT5523D_DATA_PORT, DATA);
    Lock_NCT5523D();
}
//-----

unsigned char Get_NCT5523D_Reg(unsigned char REG)
{
    unsigned char Result;
    Unlock_NCT5523D();
    outportb(NCT5523D_INDEX_PORT, REG);
    Result = inportb(NCT5523D_DATA_PORT);
    Lock_NCT5523D();
    return Result;
}
//-----

```