

# BOXER-6652

---

Fanless Embedded Box PC

User's Manual 1<sup>st</sup> Ed

## Copyright Notice

---

This document is copyrighted, 2015. All rights are reserved. The original manufacturer reserves the right to make improvements to the products described in this manual at any time without notice.

No part of this manual may be reproduced, copied, translated, or transmitted in any form or by any means without the prior written permission of the original manufacturer. Information provided in this manual is intended to be accurate and reliable. However, the original manufacturer assumes no responsibility for its use, or for any infringements upon the rights of third parties that may result from its use.

The material in this document is for product information only and is subject to change without notice. While reasonable efforts have been made in the preparation of this document to assure its accuracy, AAEMON assumes no liabilities resulting from errors or omissions in this document, or from the use of the information contained herein.

AAEMON reserves the right to make changes in the product design without notice to its users.

## Acknowledgement

---

All other products' name or trademarks are properties of their respective owners.

- AMD® is trademark of Advanced Micro Devices.
- Microsoft Windows® is a registered trademark of Microsoft Corp.
- ITE is a trademark of Integrated Technology Express, Inc.
- IBM, PC/AT, PS/2, and VGA are trademarks of International Business Machines Corporation.

All other product names or trademarks are properties of their respective owners.

## Packing List

---

Before setting up your product, please make sure the following items have been shipped:

Item	Quantity
● BOXER-6652	1
● Wallmount bracket	2
● Screw Package	1
● RAM Thermal Pad (60mm x 25mm x 3mm)	1
● Phoenix power connector	1
● Product CD with User's Manual (in pdf) and drivers	1

If any of these items are missing or damaged, please contact your distributor or sales representative immediately.

## About this Document

---

This User's Manual contains all the essential information, such as detailed descriptions and explanations on the product's hardware and software features (if any), its specifications, dimensions, jumper/connector settings/definitions, and driver installation instructions (if any), to facilitate users in setting up their product.

Users may refer to the [AAEON.com](http://AAEON.com) for the latest version of this document.

## Safety Precautions

---

Please read the following safety instructions carefully. It is advised that you keep this manual for future references

1. All cautions and warnings on the device should be noted.
2. Make sure the power source matches the power rating of the device.
3. Position the power cord so that people cannot step on it. Do not place anything over the power cord.
4. Always completely disconnect the power before working on the system's hardware.
5. No connections should be made when the system is powered as a sudden rush of power may damage sensitive electronic components.
6. If the device is not to be used for a long time, disconnect it from the power supply to avoid damage by transient over-voltage.
7. Always disconnect this device from any AC supply before cleaning.
8. While cleaning, use a damp cloth instead of liquid or spray detergents.
9. Make sure the device is installed near a power outlet and is easily accessible.
10. Keep this device away from humidity.
11. Place the device on a solid surface during installation to prevent falls
12. Do not cover the openings on the device to ensure optimal heat dissipation.
13. Watch out for high temperatures when the system is running.
14. Do not touch the heat sink or heat spreader when the system is running
15. Never pour any liquid into the openings. This could cause fire or electric shock.
16. As most electronic components are sensitive to static electrical charge, be sure to ground yourself to prevent static charge when installing the internal components. Use a grounding wrist strap and contain all electronic components in any static-shielded containers.

17. If any of the following situations arises, please the contact our service personnel:
  - i. Damaged power cord or plug
  - ii. Liquid intrusion to the device
  - iii. Exposure to moisture
  - iv. Device is not working as expected or in a manner as described in this manual
  - v. The device is dropped or damaged
  - vi. Any obvious signs of damage displayed on the device
18. **DO NOT LEAVE THIS DEVICE IN AN UNCONTROLLED ENVIRONMENT WHERE THE STORAGE TEMPERATURE IS BELOW -20° C (-4°F) OR ABOVE 70°C (158°F) TO PREVENT DAMAGE.**

### **Warning!**



This device complies with Part 15 FCC Rules. Operation is subject to the following two conditions: (1) this device may not cause harmful interference, and (2) this device must accept any interference received including interference that may cause undesired operation.

### **Caution:**

*There is a danger of explosion if the battery is incorrectly replaced. Replace only with the same or equivalent type recommended by the manufacturer. Dispose of used batteries according to the manufacturer's instructions and your local government's recycling or disposal directives.*

### **Attention:**

*Il y a un risque d'explosion si la batterie est remplacée de façon incorrecte. Ne la remplacer qu'avec le même modèle ou équivalent recommandé par le constructeur. Recycler les batteries usées en accord avec les instructions du fabricant et les directives gouvernementales de recyclage.*



## China RoHS Requirements (CN)

产品中有毒有害物质或元素名称及含量

AAEON Embedded Box PC/ Industrial System

部件名称	有毒有害物质或元素					
	铅 (Pb)	汞 (Hg)	镉 (Cd)	六价铬 (Cr(VI))	多溴联苯 (PBB)	多溴二苯醚 (PBDE)
印刷电路板 及其电子组件	×	○	○	○	○	○
外部信号 连接器及线材	×	○	○	○	○	○
外壳	×	○	○	○	○	○
中央处理器 与内存	×	○	○	○	○	○
硬盘	×	○	○	○	○	○
电源	×	○	○	○	○	○

O: 表示该有毒有害物质在该部件所有均质材料中的含量均在 SJ/T 11363-2006 标准规定的限量要求以下。

X: 表示该有毒有害物质至少在该部件的某一均质材料中的含量超出 SJ/T 11363-2006 标准规定的限量要求。

备注:

一、此产品所标示之环保使用期限, 系指在一般正常使用状况下。

二、上述部件物质中央处理器、内存、硬盘、电源为选购品。

## China RoHS Requirement (EN)

Poisonous or Hazardous Substances or Elements in Products  
 AAEON Embedded Box PC/ Industrial System

Component	Poisonous or Hazardous Substances or Elements					
	Lead (Pb)	Mercury (Hg)	Cadmium (Cd)	Hexavalent Chromium (Cr(VI))	Polybrominated Biphenyls (PBB)	Polybrominated Diphenyl Ethers (PBDE)
PCB & Other Components	x	○	○	○	○	○
Wires & Connectors for External Connections	x	○	○	○	○	○
Chassis	x	○	○	○	○	○
CPU & RAM	x	○	○	○	○	○
Hard Disk	x	○	○	○	○	○
PSU	x	○	○	○	○	○

O: The quantity of poisonous or hazardous substances or elements found in each of the component's parts is below the SJ/T 11363-2006-stipulated requirement.

X: The quantity of poisonous or hazardous substances or elements found in at least one of the component's parts is beyond the SJ/T 11363-2006-stipulated requirement.

**Note:** The Environment Friendly Use Period as labeled on this product is applicable under normal usage only

# Table of Contents

---

<b>Chapter 1 - Product Specifications</b> .....	<b>1</b>
1.1 Specifications.....	2
<b>Chapter 2 – Hardware Information</b> .....	<b>5</b>
2.1 Dimensions .....	6
2.2 List of Jumpers .....	7
2.2.1 Front Panel Connector (JP1) .....	8
2.2.2 LVDS Port Backlight Lightness Control Mode Selection (JP2) .....	8
2.2.3 LVDS Port Backlight Control Inverter VCC Selection (JP3) .....	9
2.2.4 LVDS Port Operating VDD Selection (JP4).....	9
2.2.5 AT/ATX Control Selection (JP5).....	9
2.2.6 COM2 Ring Function Selection (JP6) .....	9
2.2.7 COM1 Ring Function Selection (JP7) .....	10
2.2.8 COM4 Function Mode Selection (JP8).....	10
2.2.9 COM3 Function Mode Selection (JP9).....	10
2.2.10 COM4 Termination Selection (DCD4) (JP10) .....	10
2.2.11 COM4 Termination Selection (DTR4) (JP11) .....	11
2.2.12 COM3 Termination Selection (DCD4) (JP12) .....	11
2.2.13 COM3 Termination Selection (DTR4) (JP13) .....	11
2.2.14 Clear COMS1 Jumper (CN23) .....	11
2.2.15 Clear COMS2 Jumper (CN24) .....	12
2.3 List of Connectors.....	13
2.3.1 Audio Connector (CN1).....	15
2.3.2 LVDS Port (CN2) .....	15
2.3.3 COM Port 5 and 6 (D-SUB9) (CN3) .....	17
2.3.4 +5V/+12V Output for SATA HDD (CN4).....	18
2.3.5 USB2.0 Port 6 and 7 (CN5) .....	18

2.3.6	LVDS Port Inverter / Backlight Connector (CN6).....	19
2.3.7	UIM Card Sock (Push-Push type) (CN7).....	19
2.3.8	CFast Slot (CN8) .....	20
2.3.9	COM Port 6 (Wafer BOX, Optional) (CN9) .....	21
2.3.10	COM Port 5 (Wafer BOX, Optional) (CN10).....	21
2.3.11	SATA2.0 Connector (CN11).....	22
2.3.12	+5V / SATA Power Connector (CN12).....	22
2.3.13	PSON# Output (CN13).....	23
2.3.14	PCIe Connector (CN14).....	23
2.3.15	+3.3V and +5V Output (CN15) .....	23
2.3.16	SATA2.0 Connector (CN16).....	24
2.3.17	MiniCard Slot (Full-MiniCard) (CN17).....	24
2.3.18	MiniCard Slot (Half-MiniCard) (CN18) .....	26
2.3.19	PS/2 Keyboard/Mouse Combo Port (CN19).....	28
2.3.20	PCH Digital IO Port (CN20).....	29
2.3.21	UIM Card Socket (CN21) .....	29
2.3.22	Digital IO Port (CN22).....	30
2.3.23	LPC Port (CN26).....	30
2.3.24	USB2.0 Port 8 and 9 (Wafer BOX, Optional) (CN29).....	31
2.3.25	USB3.0 (Wafer BOX, Optional) (CN30).....	32
2.3.26	External Power Input (CN31) .....	33
2.3.27	LAN (RJ-45)+Dual USB3.0+USB2.0 (CN32).....	33
2.3.28	HDMI Port (CN33).....	35
2.3.29	LAN (RJ-45)+ Dual USB2.0 (CN34) .....	36
2.3.30	COM Port 1 and 2 (D-SUB 9) (CN35).....	37
2.3.31	COM Port 3 and 4 (D-SUB 9) (CN36).....	38
2.3.32	Adapter Power in Connector (CN37).....	39
2.3.33	VGA+DVI-D Port (CN38).....	39

2.3.34	LAN2 LED (LED 1) .....	41
2.3.35	LAN1 LED (LED 2) .....	41
2.3.36	LAN1 LED (LED 2) .....	42
2.4	Installing Components.....	43
2.4.1	Installing MiniCard .....	44
2.4.2	Installing CFast/ SIM Card .....	45
2.4.3	Installing HDD.....	46
2.4.4	Installing RAM.....	48
<b>Chapter 3 - AMI BIOS Setup .....</b>		<b>50</b>
3.1	System Test and Initialization .....	51
3.2	AMI BIOS Setup .....	52
3.3	Setup Submenu: Main.....	53
3.4	Setup Submenu: Advanced.....	54
3.4.1	F81866 Super IO Configuration.....	55
3.4.1.1	F81866 Super IO Configuration: Serial Port 1 Configuration.....	56
3.4.1.2	F81866 Super IO Configuration: Serial Port 2 Configuration.....	57
3.4.1.3	F81866 Super IO Configuration: Serial Port 3 Configuration.....	58
3.4.1.4	F81866 Super IO Configuration: Serial Port 4 Configuration.....	59
3.4.1.5	F81866 Super IO Configuration: Serial Port 5 Configuration.....	60
3.4.1.6	F81866 Super IO Configuration: Serial Port 6 Configuration.....	61
3.4.2	Advanced: F81866 H/W Monitor .....	62
3.4.3	Advanced: Power Management .....	63

3.4.4	Advanced: CPU Configuration .....	65
3.4.5	Advanced: AMT Configuration .....	67
3.4.6	Advanced: Trusted Computing .....	68
3.4.7	Advanced: SATA Configuration .....	69
3.4.8	Advanced: USB Configuration .....	70
3.4.9	Advanced: Dynamic Digital IO .....	71
3.5	Setup submenu: Chipset .....	72
3.5.1	Chipset: PCH-IO Configuration .....	73
3.5.2	Chipset: System Agent (SA) Configuration .....	75
3.5.2.1	System Agent (SA) Configuration: Memory Configuration .....	76
3.6	Setup submenu: Boot .....	77
3.6.1	Boot: BBS Priorities .....	78
3.7	Setup submenu: Security .....	79
3.8	Setup submenu: Save & Exit .....	80
<b>Chapter 4 – Drivers Installation .....</b>		<b>81</b>
4.1	Product CD/DVD .....	82
<b>Appendix A - Watchdog Timer Programming .....</b>		<b>84</b>
A.1	Watchdog Timer Initial Program .....	85
<b>Appendix B - I/O Information .....</b>		<b>90</b>
B.1	I/O Address Map .....	91
B.2	Memory Address Map .....	93
B.3	IRQ Mapping Chart .....	94
B.4	DMA Channel Assignments .....	104

# Chapter 1

---

Product Specifications

## 1.1 Specifications

---

### System

- **Processor** Intel® 4th Generation CPU
- **System Memory** 204-pin DDR3L 1333/1600 MHz SODIMM x 1, up to 16 GB
- **Chipset** Intel® QM87 PCH
- **Storage** Onboard CFast slot x 1  
2.5" SATA HDD/SSD drive bay x 1
- **Rear I/O Panel** 3-pin terminal block x 1  
DB-9 for RS-232 x 2  
DB-9 for RS-232/422/485 x 2 (isolation)  
USB2.0 type A x 2  
USB3.0 type A x 2  
DB-15 for VGA x 1  
DVI-D x 1  
HDMI 1.4a x 1  
RJ-45 for 10/100/1000Base-TX x 2
- **Front I/O Panel** Power button x 1  
DB-9 for RS-232 x 2  
CFast slot x 1  
SIM slot x 1  
USB2.0 typeA x 2  
Line-out x 1  
SMA Antenna holes x 2
- **Front Indicators** System LED x 1  
HDD LED x1



- LAN1 Tx LED x 1
- LAN1 Rx LED x 1
- LAN2 Tx LED x 1
- LAN2 Rx LED x 1
- Expansion Slot Mini Card slot x 2 (USB & PCIe signal)
- OS Support
  - Windows® 8.1
  - Windows® 7
  - Windows® Embedded Standard 7
  - Windows® Embedded Standard 8
  - Linux kernel 2.6.x or above
  - Linux Red Hat

## Mechanical

- Construction Rugged aluminum chassis
- Mounting Wallmount
- Dimension (W x H x D) 264.16 x 193.5 x 69.62 mm (10.4" x 7.62" x 2.74")
- Gross Weight 5 Kg (11 lb)

## Environmental

- Operating Temperature -20°C ~ 60°C (-4°F ~ -140°F) - with 0.5 m/s airflow (HDD/CFast)
- Storage Temperature -20°C ~ 70°C (-4°F ~ -158°F)
- Operating Humidity 5~95% @ 40°C, non-condensing
- Anti-Vibration
  - 5 Grms/ 5 ~ 500Hz Operation (CFast)
  - 1 Grms/ 5 ~ 500 Hz/ Operation (HDD)

- **Anti-Shock** 50 G peak acceleration (11 msec. duration)-CFast  
20 G peak acceleration (11 msec. duration)-HDD
- **EMC** CE/FCC Class A

## Power Supply

- **DC Input** 9 ~ 30 V, AT or ATX

# Chapter 2

---

Hardware Information

## 2.1 Dimensions

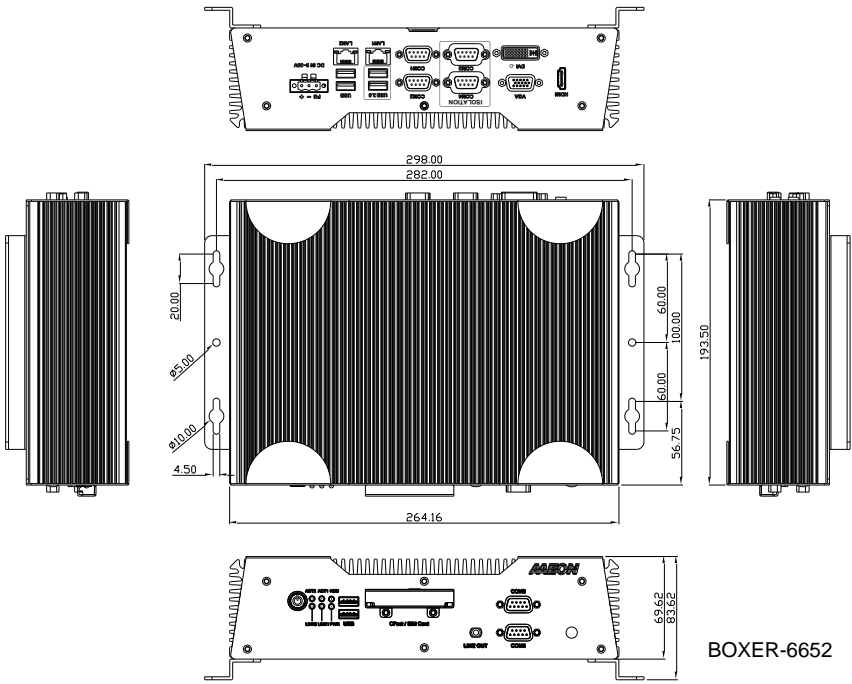

## 2.2 List of Jumpers

---

Please refer to the table below for all of the board's jumpers that you can configure for your application

Label	Function
JP1	Front Panel Connector
JP2	LVDS Port Backlight Lightness Control Mode Selection
JP3	LVDS Port Backlight Control Inverter VCC Selection
JP4	LVDS Port Operating VDD Selection
JP5	AT/ATX Control Selection
JP6	COM2 Ring Function Selection
JP7	COM1 Ring Function Selection
JP8	COM4 Function Mode Selection
JP9	COM3 Function Mode Selection
JP10	COM4 Termination Selection (DCD4)
JP11	COM4 Termination Selection (DTR4)
JP12	COM4 Termination Selection (DCD4)
JP13	COM4 Termination Selection (DTR4)
CN23	COMS1
CN24	COMS2

### 2.2.1 Front Panel Connector (JP1)

---

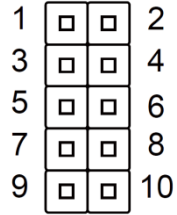

Pin	Function
1	PWR_BTN-
2	PWR_BTN+
3	HDD_LED-
4	HDD_LED+
5	SPEAKER-
6	SPEAKER+
7	PWR_LED
8	PWR_LED+
9	H/W RESET-
10	H/W RESET+

### 2.2.2 LVDS Port Backlight Lightness Control Mode Selection (JP2)

---

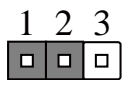

VR Mode (Default)

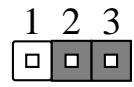

PWM Mode

### 2.2.3 LVDS Port Backlight Control Inverter VCC Selection (JP3)

---

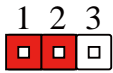

+12V

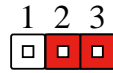

+5V (Default)

### 2.2.4 LVDS Port Operating VDD Selection (JP4)

---

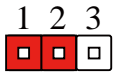

+12V

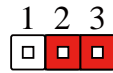

+3.3V (Default)

### 2.2.5 AT/ATX Control Selection (JP5)

---

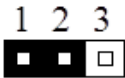

ATX

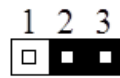

AT(Default)

### 2.2.6 COM2 Ring Function Selection (JP6)

---

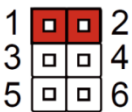

+12V

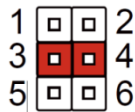

Ring(Default)

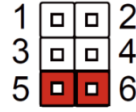

+5V

## 2.2.7 COM1 Ring Function Selection (JP7)

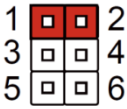

**+12V**

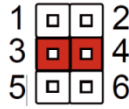

**Ring(Default)**

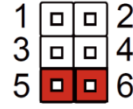

**+5V**

## 2.2.8 COM4 Function Mode Selection (JP8)

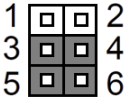

RS-422

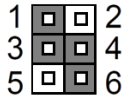

RS-232(Default)

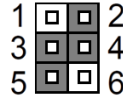

RS-485 Driver Half  
Duplex

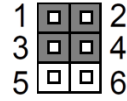

RS-485 Receiver  
Half Duplex

## 2.2.9 COM3 Function Mode Selection (JP9)

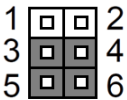

RS-422

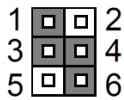

RS-232(Default)

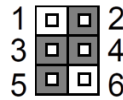

RS-485 Driver Half  
Duplex

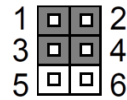

RS-485 Receiver  
Half Duplex

## 2.2.10 COM4 Termination Selection (DCD4) (JP10)

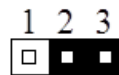
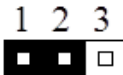



No Termination (Default)

Termination With 120 ohm

### 2.2.11 COM4 Termination Selection (DTR4) (JP11)

---

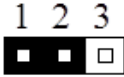

No Termination (Default)

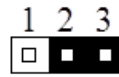

Termination With 120 ohm

### 2.2.12 COM3 Termination Selection (DCD4) (JP12)

---

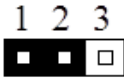

No Termination (Default)

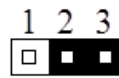

Termination With 120 ohm

### 2.2.13 COM3 Termination Selection (DTR4) (JP13)

---

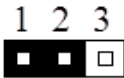

No Termination (Default)

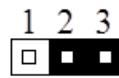

Termination With 120 ohm

### 2.2.14 Clear COMS1 Jumper (CN23)

---

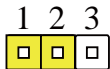

Normal (Default)

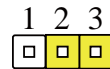

Clear CMOS

## 2.2.15 Clear COMS2 Jumper (CN24)

---

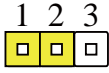

Normal (Default)

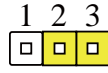

Clear CMOS

## 2.3 List of Connectors

---

Please refer to the table below for all of the board's connectors that you can configure for your application

Label	Function
CN1	Audio Connector
CN2	LVDS Port
CN3	COM Port 5 and 6 (D-SUB9)
CN4	+5V/+12V Output for SATA HDD
CN5	USB2.0 Port 6 and 7
CN6	LVDS Port Inverter / Backlight Connector
CN7	UIM Card Sock (Push-Push type)
CN8	CFast Slot
CN9	COM Port 6 (Wafer BOX, Optional)
CN10	COM Port 5 (Wafer BOX, Optional)
CN11	SATA2.0 Connector
CN12	+5V / SATA Power Connector
CN13	PSION# Output
CN14	PCIe Connector
CN15	+3.3V and +5V Output
CN16	SATA2.0 Connector
CN17	Mini-Card Slot (Full-Mini Card)
CN18	Mini-Card Slot (Half-Mini Card)
CN19	PS/2 Keyboard/Mouse Combo Port
CN20	PCH Digital IO Port
CN21	UIM Card Socket
CN22	Digital IO Port
CN26	LPC Port

CN29	USB2.0 Port 8 and 9 (Wafer BOX, Optional)
CN30	USB3.0 (Wafer BOX, Optional)
CN31	Adapter Power in Connector
CN32	LAN (RJ-45)+Dual USB3.0+USB2.0
CN33	HDMI Port
CN34	LAN (RJ-45)+Dual USB2.0
CN35	COM Port 1 and 2 (D-SUB 9)
CN36	COM Port 3 and 4 (D-SUB 9)
CN37	External Power Input
CN38	VGA+DVI-D Port
LED1	LAN1 LED
LED2	LED2 LED
LED3	LAN2 LED

### 2.3.1 Audio Connector (CN1)

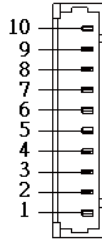

Pin	Pin name	Signal Type	Signal Level
1	MIC_L	I/O	
2	MIC_R	I/O	
3	GND	GND	
4	LIN_L	I/O	
5	LIN_R	I/O	
6	GND	GND	
7	LOUT_L	I/O	
8	GND	GND	
9	LOUT_R	I/O	
10	+VDD_AUD	PWR	

### 2.3.2 LVDS Port (CN2)

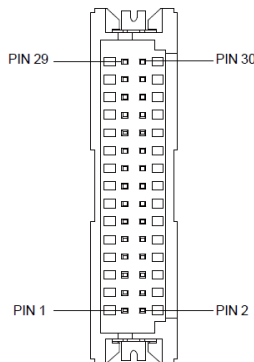

Pin	Pin Name	Signal Type	Signal Level
1	LVDS_BKLTEN	OUT	
2	LVDS_BKLCTL_CON	OUT	
3	+VDD_LVDS	PWR	
4	GND	GND	
5	LVDSA_CLK#	DIFF	
6	LVDSA_CLK	DIFF	
7	+VDD_LVDS	PWR	
8	GND	GND	
9	LVDSA_DATA0#	DIFF	
10	LVDSA_DATA0	DIFF	
11	LVDSA_DATA1#	DIFF	
12	LVDSA_DATA1	DIFF	
13	LVDSA_DATA2#	DIFF	
14	LVDSA_DATA2	DIFF	
15	LVDSA_DATA3#	DIFF	
16	LVDSA_DATA3	DIFF	
17	LVDS_DDC_DATA	DIFF	
18	LVDS_DDC_CLK	DIFF	
19	LVDSB_DATA0#	DIFF	
20	LVDSB_DATA0	DIFF	
21	LVDSB_DATA1#	DIFF	
22	LVDSB_DATA1	DIFF	
23	LVDSB_DATA2#	DIFF	
24	LVDSB_DATA2	DIFF	
25	LVDSB_DATA3#	DIFF	
26	LVDSB_DATA3	DIFF	
27	+VDD_LVDS	PWR	

28	GND	GND
29	LVDSB_CLK#	DIFF
30	LVDSB_CLK	DIFF

### 2.3.3 COM Port 5 and 6 (D-SUB9) (CN3)

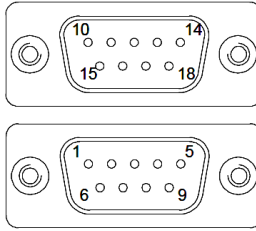

Pin	Pin Name	Signal Type	Signal Level
1	DCD5	IN	
2	RX5	IN	
3	TX5	OUT	
4	DTR5	OUT	
5	GND	GND	
6	DSR5	IN	
7	RT5	OUT	
8	CTS5	IN	
9	RI5	IN	
10	DCD6	IN	
11	RX6	IN	
12	TX6	OUT	
13	DTR6	OUT	
14	GND	GND	
15	DSR6	IN	
16	RT6	OUT	
17	CTS6	IN	

### 2.3.4 +5V/+12V Output for SATA HDD (CN4)

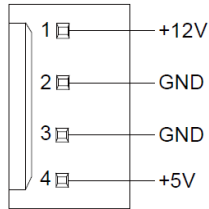

Pin	Pin Name	Signal Type	Signal Level
1	+12V	PWR	12V
2	GND	GND	
3	GND	GND	
4	+5V	PWR	5V

### 2.3.5 USB2.0 Port 6 and 7 (CN5)

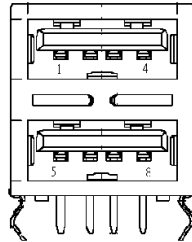

Pin	Pin Name	Signal Type	Signal Level
1	+V5A_USB_6_7	PWR	
2	USBD6-	DIFF	
3	USBD6+	DIFF	
4	GND	GND	
5	+V5A_USB_6_7	PWR	



6	USBD7-	DIFF
7	USBD7+	DIFF
8	GND	GND

### 2.3.6 LVDS Port Inverter / Backlight Connector (CN6)

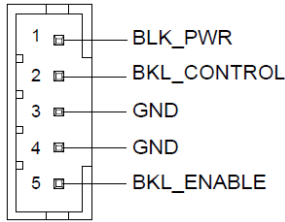

Pin	Pin Name	Signal Type	Signal Level
1	+VCC_LVDS_BKLT	PWR	+5V/+12V
2	L_BKLTNESS	OUT	
3	GND	GND	
4	GND	GND	
5	LVDS_BKLTEN	OUT	

### 2.3.7 UIM Card Sock (Push-Push type) (CN7)

Pin	Pin Name	Signal Type	Signal Level
C1	UIM_PWR1	I/O	
C2	UIM_RST1	I/O	
C3	UIM_CLK1	I/O	
C5	GND	GND	
C6	UIM_VPP1	I/O	
C7	UIM_DAT1	I/O	
DET1	GND	GND	

### 2.3.8 CFast Slot (CN8)

Pin	Pin Name	Signal Type	Signal Level
S1	GND	GND	
S3	CFast_TXN2_C	DIFF	
S5	CFast_RXN2_C	DIFF	
S7	GND	GND	
PC2	GND	GND	
PC4	NC		
PC6	NC		
PC8	NC		
PC10	NC		
PC12	NC		
PC14	+3.3V	PWR	
PC16	GND	GND	
S1	GND	GND	
S3	CFast_TXN2_C	DIFF	
S5	CFast_RXN2_C	DIFF	
S7	GND	GND	
PC2	GND	GND	
PC4	NC		
PC6	NC		
PC8	NC		
PC10	NC		
PC12	NC		
PC14	+3.3V	PWR	
PC16	GND	GND	

### 2.3.9 COM Port 6 (Wafer BOX, Optional) (CN9)

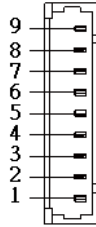

Pin	Pin Name	Signal Type	Signal Level
1	DCD	I/O	DCD
2	DSR	I/O	
3	RX	I/O	±5V
4	RTS	I/O	
5	TX	I/O	±5V
6	CTS	I/O	
7	DTR	I/O	
8	RI	PWR	+5V/ +12V
9	GND	GND	

### 2.3.10 COM Port 5 (Wafer BOX, Optional) (CN10)

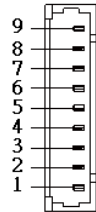

Pin	Pin Name	Signal Type	Signal Level
1	DCD	I/O	DCD
2	DSR	I/O	

3	RX	I/O	±5V
4	RTS	I/O	
5	TX	I/O	±5V
6	CTS	I/O	
7	DTR	I/O	
8	RI	PWR	+5V/ +12V
9	GND	GND	

### 2.3.11 SATA2.0 Connector (CN11)

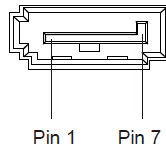

Pin	Pin Name	Signal Type	Signal Level
1	GND	GND	
2	SATA_TXP1_C	DIFF	
3	SATA_TXN1_C	DIFF	
4	GND	GND	
5	SATA_RXN1_C	DIFF	
6	SATA_RXP1_C	DIFF	
7	GND	GND	

### 2.3.12 +5V / SATA Power Connector (CN12)

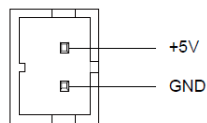

Pin	Pin Name	Signal Type	Signal Level
1	+5V	PWR	+5V
2	GND	GND	

### 2.3.13 PSON# Output (CN13)

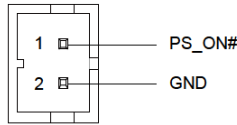

Pin	Pin Name	Signal Type	Signal Level
1	PS_ON#		
2	GND	GND	

### 2.3.14 PCIe Connector (CN14)

Standard specification

### 2.3.15 +3.3V and +5V Output (CN15)

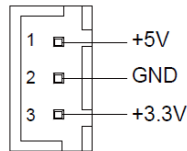

Pin	Pin Name	Signal Type	Signal Level
1	+5V	PWR	
2	GND	GND	
3	3.3V	PWR	

### 2.3.16 SATA2.0 Connector (CN16)

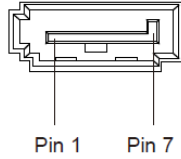

Pin	Pin Name	Signal Type	Signal Level
1	GND		
2	SATA_TXP	DIFF	
3	SATA_TXN	DIFF	
4	GND		
5	SATA_RXN	DIFF	
6	SATA_RXP	DIFF	
7	GND		

### 2.3.17 MiniCard Slot (Full-MiniCard) (CN17)

Pin	Pin Name	Signal Type	Signal Level
1	PCIE_WAKE#	IN	
2	+3.3VSB	PWR	+3.3V
3	NC		
4	GND	GND	
5	NC		
6	+1.5V	PWR	+1.5V
7	PCIE_CLK_REQ#	IN	
8	UIM_PWR	PWR	
9	GND	GND	

10	UIM_DATA	I/O	
11	PCIE_REF_CLK-	DIFF	
12	UIM_CLK	IN	
13	PCIE_REF_CLK+	DIFF	
14	UIM_RST	IN	
15	GND	GND	
16	UIM_VPP	PWR	
17	NC		
18	GND	GND	
19	NC		
20	W_DISABLE#	OUT	+3.3V
21	GND	GND	
22	PCIE_RST#	OUT	+3.3V
23	PCIE_RX-	DIFF	
24	+3.3VSB	PWR	+3.3V
25	PCIE_RX+	DIFF	
26	GND	GND	
27	GND	GND	
28	+1.5V	PWR	+1.5V
29	GND	GND	
30	SMB_CLK	I/O	+3.3V
31	PCIE_TX-	DIFF	
32	SMB_DATA	I/O	+3.3V
33	PCIE_TX+	DIFF	
34	GND	GND	
35	GND	GND	
36	USB_D-	DIFF	
37	GND	GND	

38	USB_D+	DIFF	
39	+3.3VSB	PWR	+3.3V
40	GND	GND	
41	+3.3VSB	PWR	+3.3V
42	NC		
43	GND	GND	
44	NC		
45	NC		
46	NC		
47	NC		
48	+1.5V	PWR	+1.5V
49	NC		
50	GND	GND	
51	NC		
52	+3.3VSB	PWR	+3.3V

### 2.3.18 MiniCard Slot (Half-MiniCard) (CN18)

Pin	Pin Name	Signal Type	Signal Level
1	PCIE_WAKE#	IN	
2	+3.3VSB	PWR	+3.3V
3	NC		
4	GND	GND	
5	NC		
6	+1.5V	PWR	+1.5V
7	PCIE_CLK_REQ#	IN	
8	UIM_PWR	PWR	
9	GND	GND	



10	UIM_DATA	I/O	
11	PCIE_REF_CLK-	DIFF	
12	UIM_CLK	IN	
13	PCIE_REF_CLK+	DIFF	
14	UIM_RST	IN	
15	GND	GND	
16	UIM_VPP	PWR	
17	NC		
18	GND	GND	
19	NC		
20	W_DISABLE#	OUT	+3.3V
21	GND	GND	
22	PCIE_RST#	OUT	+3.3V
23	PCIE_RX-	DIFF	
24	+3.3VSB	PWR	+3.3V
25	PCIE_RX+	DIFF	
26	GND	GND	
27	GND	GND	
28	+1.5V	PWR	+1.5V
29	GND	GND	
30	SMB_CLK	I/O	+3.3V
31	PCIE_TX-	DIFF	
32	SMB_DATA	I/O	+3.3V
33	PCIE_TX+	DIFF	
34	GND	GND	
35	GND	GND	
36	USB_D-	DIFF	
37	GND	GND	

38	USB_D+	DIFF	
39	+3.3VSB	PWR	+3.3V
40	GND	GND	
41	+3.3VSB	PWR	+3.3V
42	NC		
43	GND	GND	
44	NC		
45	NC		
46	NC		
47	NC		
48	+1.5V	PWR	+1.5V
49	NC		
50	GND	GND	
51	NC		
52	+3.3VSB	PWR	+3.3V

### 2.3.19 PS/2 Keyboard/Mouse Combo Port (CN19)

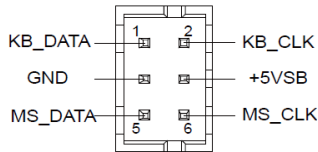

Pin	Pin Name	Signal Type	Signal Level
1	KB_DATA		
2	KB_CLK		
3	GND	GND	
4	+V5A_KBMS	PWR	+5V
5	MS_DATA		
6	MS_CLK		

### 2.3.20 PCH Digital IO Port (CN20)

---

Pin	Pin Name	Signal Type	Signal Level
1	PCH_GPIO0		
2	GND		
3	PCH_GPIO1		
4	GND		
5	PCH_GPIO2		
6	GND		
7	PCH_GPIO3		
8	GND		

### 2.3.21 UIM Card Socket (CN21)

---

Pin	Pin Name	Signal Type	Signal Level
1	UIM_PWR1	I/O	
2	UIM_RST1	I/O	
3	UIM_CLK1	I/O	
4	GND	GND	
5	UIM_VPP1	I/O	
6	UIM_DAT1	I/O	

### 2.3.22 Digital IO Port (CN22)

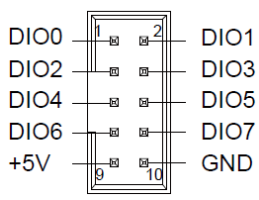

Pin	Pin Name	Signal Type	Signal Level
1	DIO_0	I/O	
2	DIO_1	I/O	
3	DIO_2	I/O	
4	DIO_3	I/O	
5	DIO_4	I/O	
6	DIO_5	I/O	
7	DIO_6	I/O	
8	DIO_7	I/O	
9	VCC_5V0	PWR	+5V
10	GND	GND	

### 2.3.23 LPC Port (CN26)

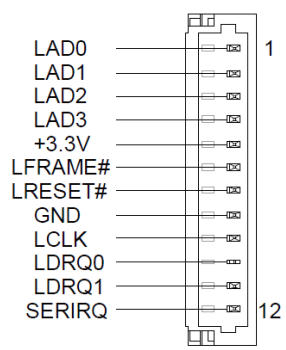

Pin	Pin Name	Signal Type	Signal Level
1	LPC_AD0		
2	LPC_AD1		
3	LPC_AD2		
4	LPC_AD3		
5	VCC_3V3	PWR	
6	LPC_FRAME#		
7	BUF_PLT_RST#		
8	GND	GND	
9	CLK_PCI_FIN		
10	PCH_DRQ#0		
11	PCH_DRQ#1		
12	INT_SERIRQ		

### 2.3.24 USB2.0 Port 8 and 9 (Wafer BOX, Optional) (CN29)

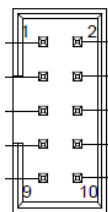

Pin	Pin Name	Signal Type	Signal Level
1	+V5A_USB_8_9	PWR	+5V
2	GND	GND	
3	USBD8-	DIFF	
4	GND	GND	
5	USBD8+	DIFF	
6	USBD9+	DIFF	
7	GND	GND	

8	USBD9-	DIFF	
9	GND	GND	
10	+V5A_USB_8_9	PWR	+5V

### 2.3.25 USB3.0 (Wafer BOX, Optional) (CN30)

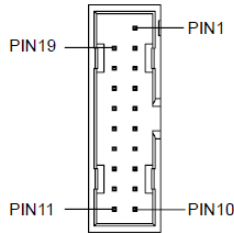

Pin	Pin Name	Signal Type	Signal Level
1	+V5A_USB_2_3	PWR	+5V
2	USB3_RX0_BH_N	I/O	
3	USB3_RX0_BH_P	I/O	
4	GND		
5	USB3_TX0_BH_N		
6	USB3_TX0_BH_P		
7	GND		
8	USBD2-		
9	USBD2+		
10	NC		
11	USBD3+		
12	USBD3-		
13	GND		
14	USB3_TX1_BH_P		
15	USB3_TX1_BH_N		

16	GND		
17	USB3_RX1_BH_P		
18	USB3_RX1_BH_N		
19	+V5A_USB_2_3	PWR	+5V

### 2.3.26 External Power Input (CN31)

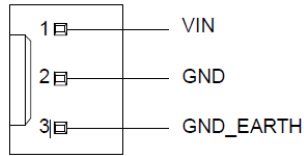

Pin	Pin Name	Signal Type	Signal Level
1	+VIN_EXT	PWR	
2	GND	GND	
3	GND_EARTH	GND	

### 2.3.27 LAN (RJ-45)+Dual USB3.0+USB2.0 (CN32)

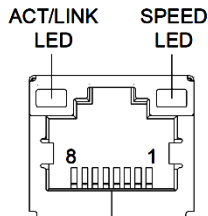

Pin	Pin Name	Signal Type	Signal Level
1	LAN1_MDI0P	I/O	
2	LAN1_MDI0N	I/O	
3	LAN1_MDI1P	I/O	
4	LAN1_MDI1N	I/O	
5	LAN1_MDI2P	I/O	

6	LAN1_MDI2N	I/O
7	LAN1_MDI3P	I/O
8	LAN1_MDI3N	I/O

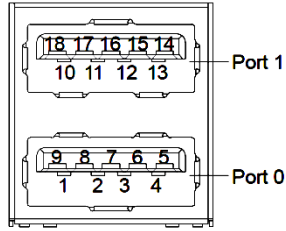

Pin	Pin Name	Signal Type	Signal Level
U1	+V5A_USB_0_1	PWR	+5V
U2	USBD0-	DIFF	
U3	USBD0+	DIFF	
U4	GND	GND	
U5	USB3_RX0_CON_N	DIFF	
U6	USB3_RX0_CON_P	DIFF	
U7	GND	GND	
U8	USB3_TX0_CON_N	DIFF	
U9	USB3_TX0_CON_P	DIFF	
U10	+V5A_USB_0_1	PWR	+5V
U11	USBD1-	DIFF	
U12	USBD1+	DIFF	
U13	GND	GND	
U14	USB3_RX1_CON_N	DIFF	
U15	USB3_RX1_CON_P	DIFF	
U16	GND	GND	
U17	USB3_TX1_CON_N	DIFF	
U18	USB3_TX1_CON_P	DIFF	



## 2.3.28 HDMI Port (CN33)

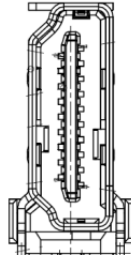

Pin	Pin Name	Signal Type	Signal Level
1	HDMI_DATA2_P	DIFF	
2	GND	GND	
3	HDMI_DATA2_N	DIFF	
4	HDMI_DATA1_P	DIFF	
5	GND	GND	
6	HDMI_DATA1_N	DIFF	
7	HDMI_DATA0_P	DIFF	
8	GND	GND	
9	HDMI_DATA0_N	DIFF	
10	HDMI_CLK_P	DIFF	
11	GND	GND	
12	HDMI_CLK_N	DIFF	
13	NC		
14	NC		
15	HDMI_SCL		
16	HDMI_SDA		
17	GND	GND	
18	+5V_HDMI	PWR	+5V
19	HDMI_HPD		

### 2.3.29 LAN (RJ-45)+ Dual USB2.0 (CN34)

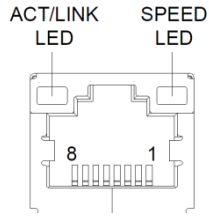

Pin	Pin Name	Signal Type	Signal Level
1	LAN2_MDI0P		
2	LAN2_MDI0N		
3	LAN2_MDI1P		
4	LAN2_MDI1N		
5	LAN2_MDI2P		
6	LAN2_MDI2N		
7	LAN2_MDI3P		
8	LAN2_MDI3N		

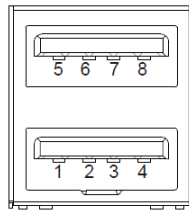

Pin	Pin Name	Signal Type	Signal Level
U1	+V5A_USB_4_5	PWR	+5V
U2	USB4-	DIFF	
U3	USB4+	DIFF	
U4	GND	GND	
U5	+V5A_USB_4_5	PWR	+5V
U6	USB5-	DIFF	

U7	USBD5+	DIFF
U8	GND	GND

### 2.3.30 COM Port 1 and 2 (D-SUB 9) (CN35)

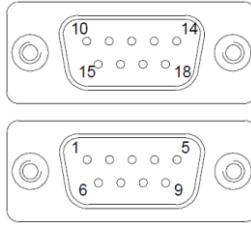

Pin	Pin Name	Signal Type	Signal Level
1	DCD1	I/O	
2	RX1	I/O	±5V
3	TX1	I/O	±5V
4	DTR1	I/O	
5	GND	GND	
6	DSR1	I/O	
7	RT1	I/O	
8	CTS1	I/O	
9	RI1	PWR	+5V/+12V
10	DCD2	I/O	
11	RX2	I/O	±5V
12	TX2	I/O	±5V
13	DTR2	I/O	
14	GND	GND	
15	DSR2	I/O	
16	RT2	I/O	
17	CTS2	I/O	
18	RI2	PWR	+5V/+12V

### 2.3.31 COM Port 3 and 4 (D-SUB 9) (CN36)

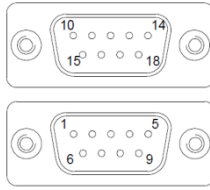

Pin	Pin Name	Signal Type	Signal Level
1	DCD3	I/O	
2	RX3	I/O	±5V
3	TX3	I/O	±5V
4	DTR3	I/O	
5	GND	GND	
6	DSR3	I/O	
7	RT3	I/O	
8	CTS3	I/O	
9	RI3	PWR	+5V/+12V
10	DCD4	I/O	
11	RX4	I/O	±5V
12	TX4	I/O	±5V
13	DTR4	I/O	
14	GND	GND	
15	DSR4	I/O	
16	RT4	I/O	
17	CTS4	I/O	
18	RI4	PWR	+5V/+12V

### 2.3.32 Adapter Power in Connector (CN37)

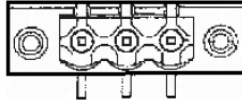

PIN1 PIN2 PIN3

Pin	Pin Name	Signal Type	Signal Level
1	+VIN_EXT	PWR	
2	GND_PRI	GND	
3	GND_EARTH	GND	

### 2.3.33 VGA+DVI-D Port (CN38)

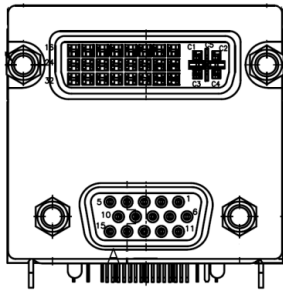

Pin	Pin Name	Signal Type	Signal Level
1	DVI_DATA2_N	DIFF	
2	DVI_DATA2_P	DIFF	
3	GND	GND	
4	NC		
5	NC		
6	DVI_DDC_SCL		
7	DVI_DDC_SDA		
8	NC		

9	DVI_DATA1_N	DIFF	
10	DVI_DATA1_P	DIFF	
11	GND		
12	NC		
13	NC		
14	+V5S_DVI_CON	PWR	+5V
15	GND		
16	DVI_HPD		
17	DVI_DATA0_N	DIFF	
18	DVI_DATA0_P	DIFF	
19	GND		
20	NC		
21	NC		
22	GND		
23	DVI_CLK_P	DIFF	
24	DVI_CLK_N	DIFF	
25	GND		
26	GND		
27	GND		
28	GND		
29	DDC_CLK		
30	NC		
31	+V5S_DISP	PWR	+5V
32	HSYNC		
33	GREEN		
34	GND		
35	NC		
36	GND		

37	CRT_PLUG
38	VSYNC
39	BLUE
40	GND
41	DDC_DAT
42	RED
43	GND

### 2.3.34 LAN2 LED (LED 1)

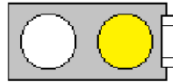

Pin	Pin Name	Signal Type	Signal Level
1	+3.3V		
2	LAN2_LINK_ACT#		
3	LAN2_1000#		
4	LAN2_100#		

### 2.3.35 LAN1 LED (LED 2)



Pin	Pin Name	Signal Type	Signal Level
1	+3.3V		
2	LAN1_LINK_ACT#		

3 LAN1\_1000#

4 LAN1\_100#

### 2.3.36 LAN1 LED (LED 2)

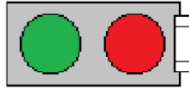

Pin	Pin Name	Signal Type	Signal Level
1	+5V		
2	HDD_LED-		
3	+5V		
4	PWR_LED-		



## 2.4 Installing Components

To installing components such as hard disks and RAMs, you will have to access the system's interior. Please follow the instructions below to do so.

### 1. Remove the stands

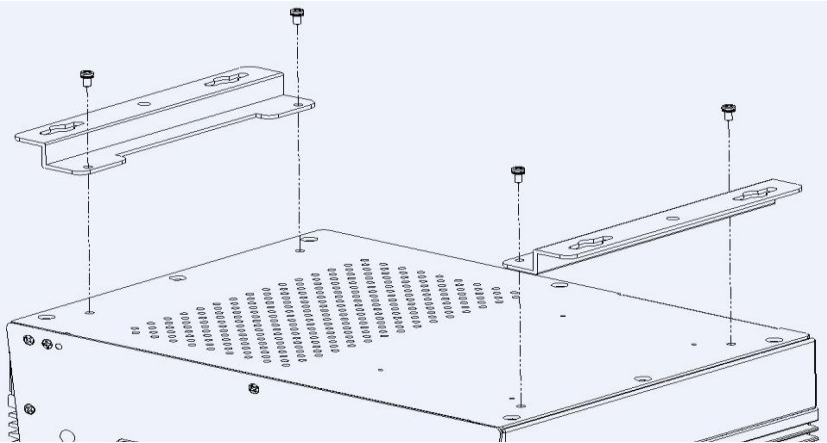

### 2. Remove the base

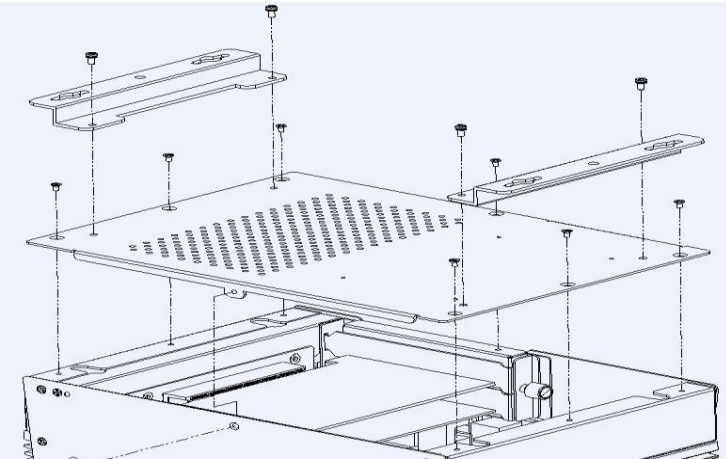

## 2.4.1 Installing MiniCard

---

1. Slot the MiniCard into the slot diagonally



2. Secure the card with screws



## 2.4.2 Installing CFast/ SIM Card

---

1. Remove the cover to insert the cards

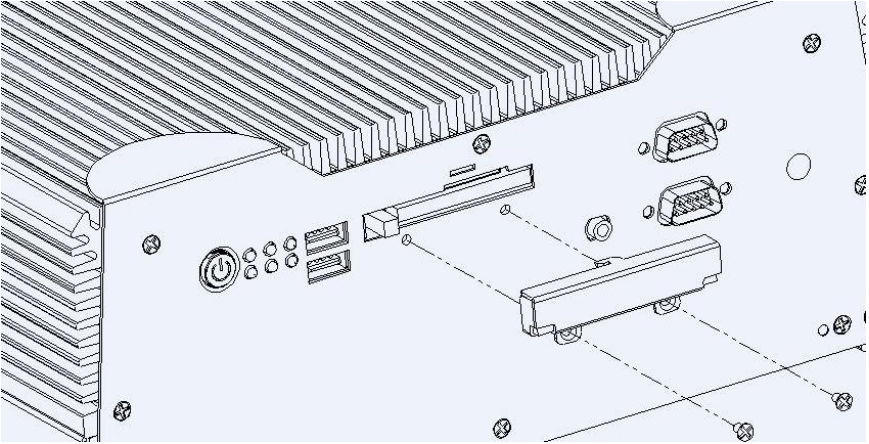

## 2.4.3 Installing HDD

1. Place the HDD onto the bracket plate and secure with screws

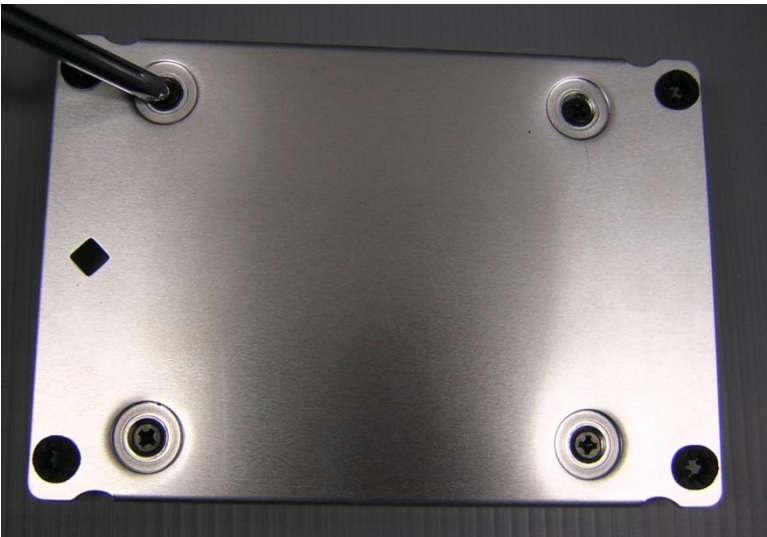

2. Place the assembly onto the baseplate and secure with screws



## 2.4.4 Installing RAM

1. Slot the RAM diagonally into the RAM slot and push down to secure

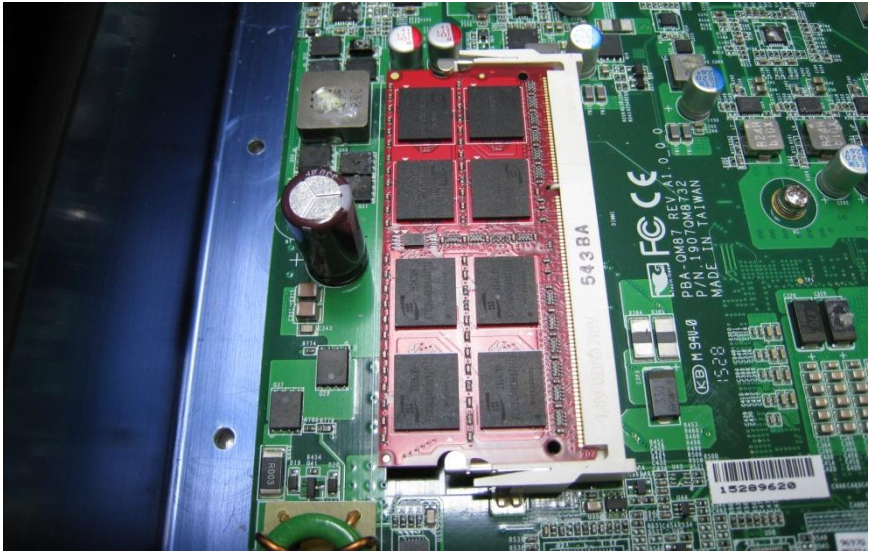

2. Place the thermal pad onto the RAM

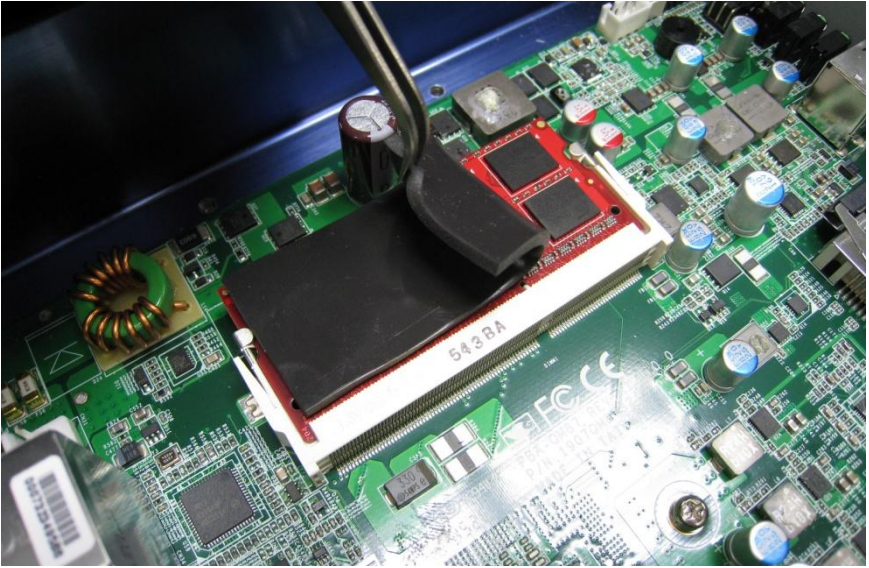

3. Place the cover onto the RAM, tighten the screws to secure the cover



# Chapter 3

---

AMI BIOS Setup



## 3.1 System Test and Initialization

---

The system uses certain routines to perform testing and initialization. If an error, fatal or non-fatal, is encountered, a few short beeps or an error message will be outputted. The board can usually continue the boot up sequence with non-fatal errors.

The system configuration verification routines check the current system configuration against the values stored in the CMOS memory. If they do not match, an error message will be outputted, in which case you will need to run the BIOS setup program to set the configuration information in memory.

There are three situations in which you will need to change the CMOS settings:

- You are starting your system for the first time
- You have changed your system's hardware
- The CMOS memory has lost power and the configuration information is erased

The system's CMOS memory uses a backup battery for data retention, which is to be replaced once emptied.

## 3.2 AMI BIOS Setup

---

The AMI BIOS ROM has a pre-installed Setup program that allows users to modify basic system configurations, which is stored in the battery-backed CMOS RAM and BIOS NVRAM so that the information is retained when the power is turned off.

To enter BIOS Setup, press <Del> or <F2> immediately while your computer is powering up.

The function for each interface can be found below.

**Main** – Date and time can be set here. Press <Tab> to switch between date elements

**Advanced** – Enable/ Disable boot option for legacy network devices

**Chipset** – For hosting bridge parameters

**Boot** – Enable/ Disable quiet Boot Option

**Security** – The setup administrator password can be set here

**Save & Exit** – Save your changes and exit the program

### 3.3 Setup Submenu: Main

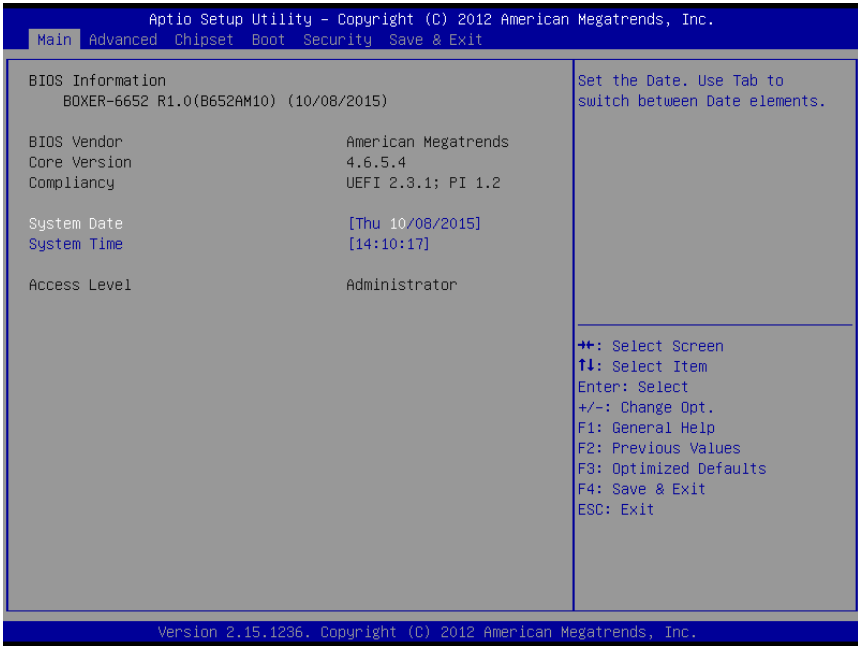

### 3.4 Setup Submenu: Advanced

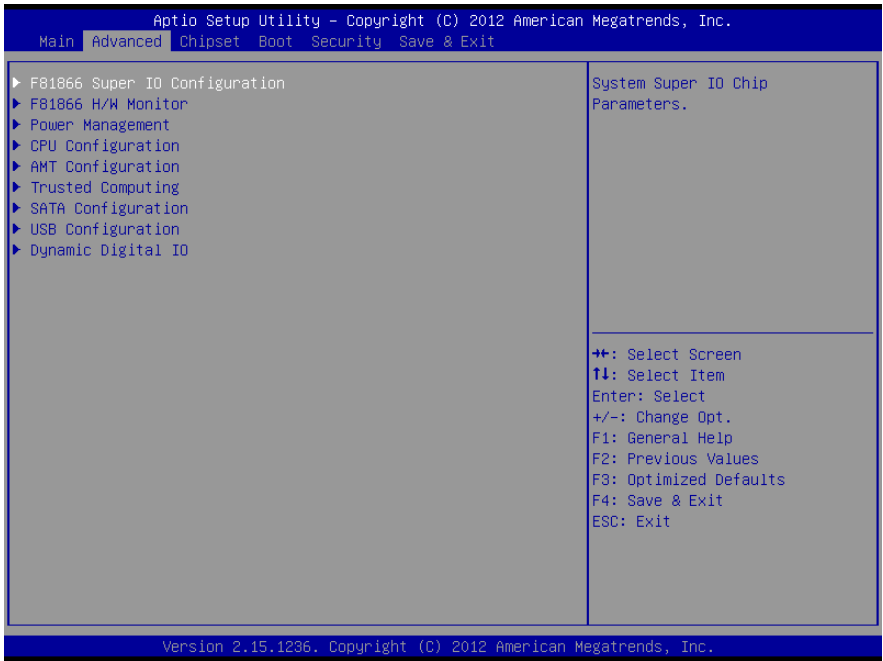

### 3.4.1 F81866 Super IO Configuration



### 3.4.1.1 F81866 Super IO Configuration: Serial Port 1 Configuration



Options summary:

<b>Serial Port</b>	Disabled	
	Enabled	Optimal Default, Failsafe Default
Enable or Disable Serial Port (COM)		
<b>Change Settings</b>	Auto	Optimal Default, Failsafe Default
	IO=3E8h; IRQ=4;	
	IO=3F8h; IRQ=3,4,5,6,7,10,11,12;	
	IO=2E8h; IRQ=3,4,5,6,7,10,11,12;	
	IO=3E8h; IRQ=10;	
	IO=2E8h; IRQ=10;	
Select an optimal setting for Super IO device		

### 3.4.1.2 F81866 Super IO Configuration: Serial Port 2 Configuration

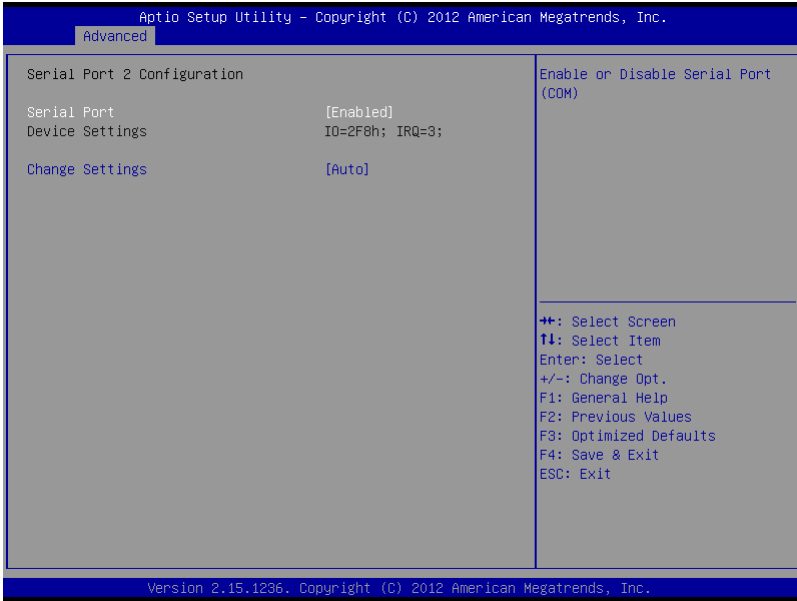

Options summary:

Serial Port	Disabled	
	Enabled	Optimal Default, Failsafe Default
Enable or Disable Serial Port (COM)		
Change Settings	Auto	Optimal Default, Failsafe Default
	IO=2E8h; IRQ=3;	
	IO=3F8h; IRQ=3,4;	
	IO=2F8h; IRQ=3,4;	
	IO=3E8h; IRQ=3,4;	
	IO=2E8h; IRQ=3,4;	
Select an optimal setting for Super IO device		

### 3.4.1.3 F81866 Super IO Configuration: Serial Port 3 Configuration

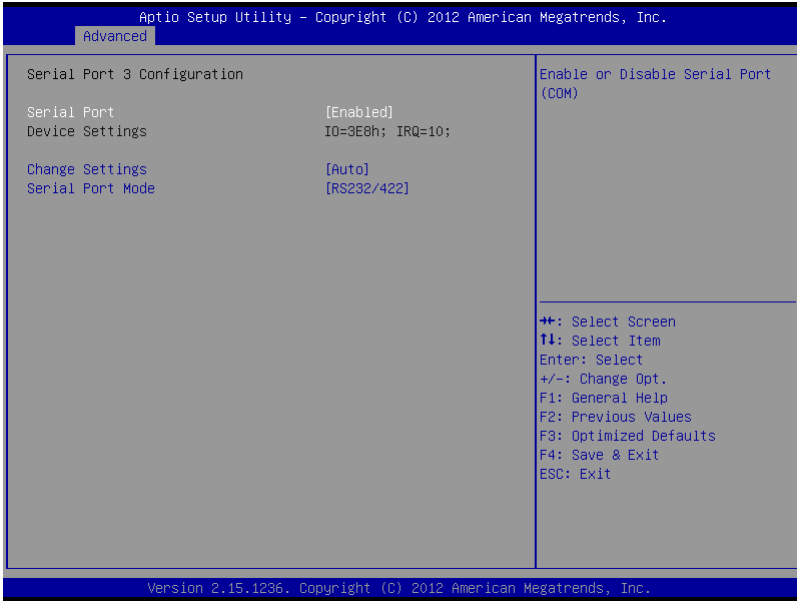

Options summary:

<b>Serial Port</b>	Disabled	
	Enabled	Optimal Default, Failsafe Default
Enable or Disable Serial Port (COM)		
<b>Change Settings</b>	Auto	Optimal Default, Failsafe Default
	IO=3E8h; IRQ=10;	
	IO=3E8h; IRQ=10;	
	IO=2E8h; IRQ=10;	
	IO=2D0h; IRQ=10;	
	IO=2C0h; IRQ=10;	
Select an optimal setting for Super IO device		
<b>Serial Port Mode</b>	RS232/422	Optimal Default, Failsafe Default
	RS485	
Serial Port Mode selection For switch RS232/422/485 mode		



### 3.4.1.4 F81866 Super IO Configuration: Serial Port 4 Configuration

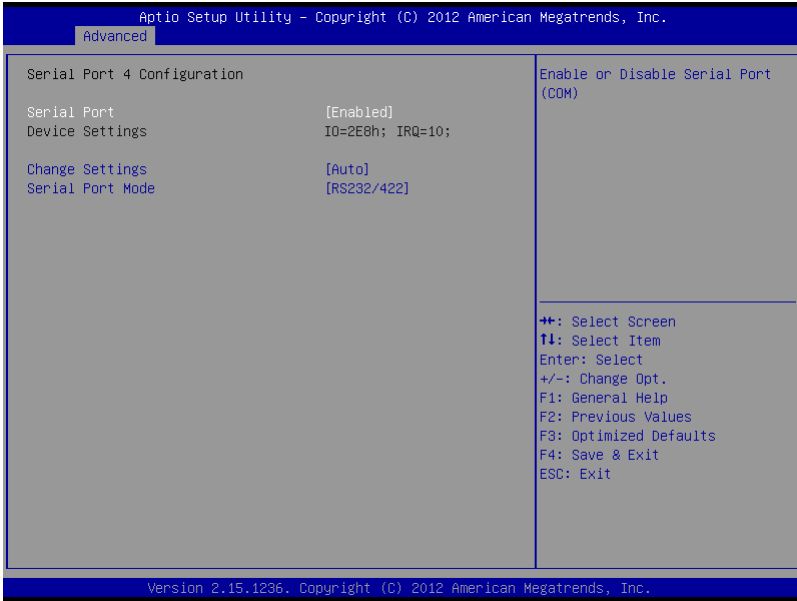

Options summary:

<b>Serial Port</b>	Disabled	
	Enabled	Optimal Default, Failsafe Default
Enable or Disable Serial Port (COM)		
<b>Change Settings</b>	Auto	Optimal Default, Failsafe Default
	IO=2E8h; IRQ=10;	
	IO=3E8h; IRQ=10;	
	IO=2E8h; IRQ=10;	
	IO=2D0h; IRQ=10;	
	IO=2C0h; IRQ=10;	
Select an optimal setting for Super IO device		
<b>Serial Port Mode</b>	RS232/422	Optimal Default, Failsafe Default
	RS485	
Serial Port Mode selection For switch RS232/422/485 mode		

### 3.4.1.5 F81866 Super IO Configuration: Serial Port 5 Configuration

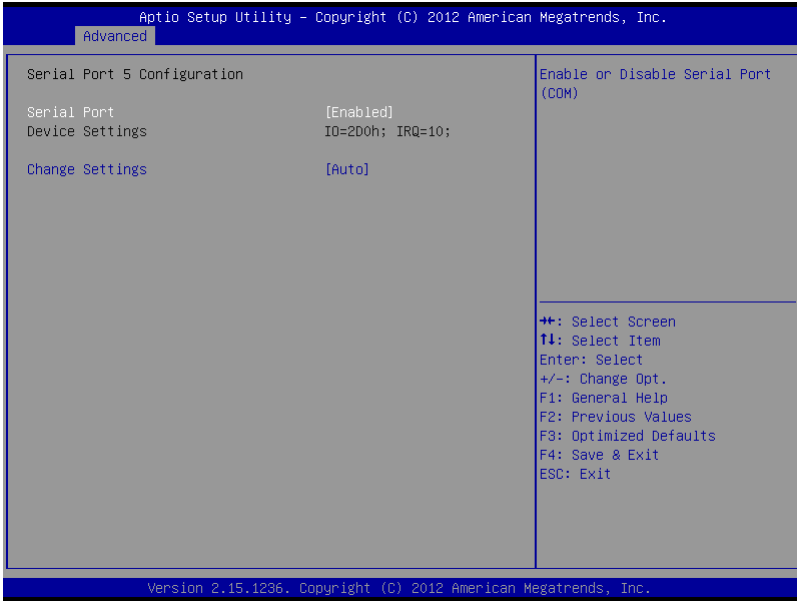

Options summary:

<b>Serial Port</b>	Disabled	
	Enabled	Optimal Default, Failsafe Default
Enable or Disable Serial Port (COM)		
<b>Change Settings</b>	Auto	Optimal Default, Failsafe Default
	IO=2F0h; IRQ=10;	
	IO=3E8h; IRQ=10;	
	IO=2E8h; IRQ=10;	
	IO=2D0h; IRQ=10;	
	IO=2C0h; IRQ=10;	
Select an optimal setting for Super IO device		

### 3.4.1.6 F81866 Super IO Configuration: Serial Port 6 Configuration

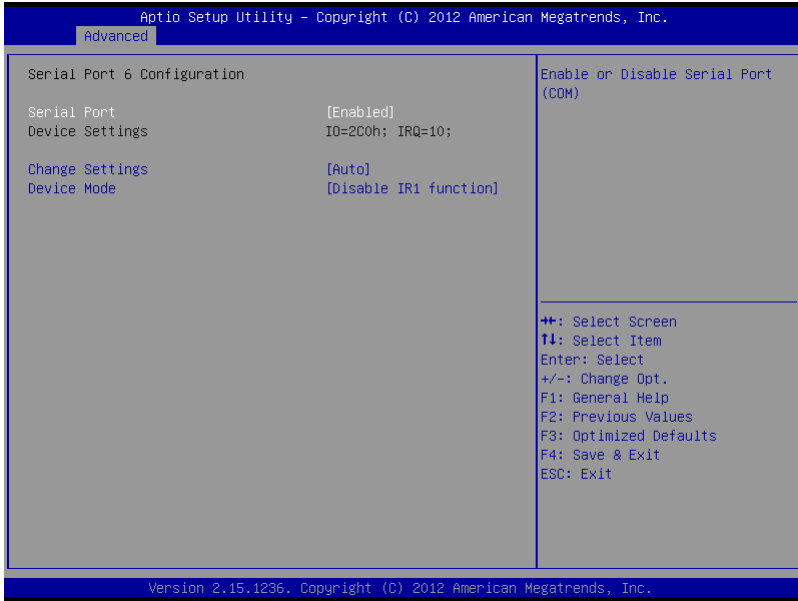

Options summary:

<b>Serial Port</b>	Disabled	
	Enabled	Optimal Default, Failsafe Default
Enable or Disable Serial Port (COM)		
<b>Change Settings</b>	Auto	Optimal Default, Failsafe Default
	IO=2E0h; IRQ=10;	
	IO=3E8h; IRQ=10;	
	IO=2E8h; IRQ=10;	
	IO=2D0h; IRQ=10;	
Select an optimal setting for Super IO device		
<b>Device Mode</b>	Disable IR1 function	Optimal Default, Failsafe Default
	Enable IR1 function, active pulse 1.6uS	
	Enable IR1 function, active pulse 3/16 bit time	
Change the Serial Port mode. Select <High Speed> or <Normal mode> mode		

### 3.4.2 Advanced: F81866 H/W Monitor

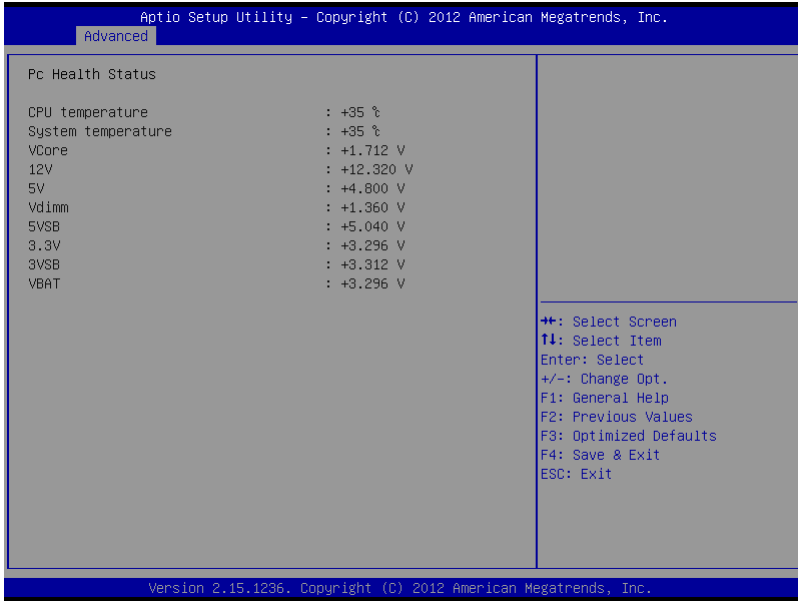

### 3.4.3 Advanced: Power Management

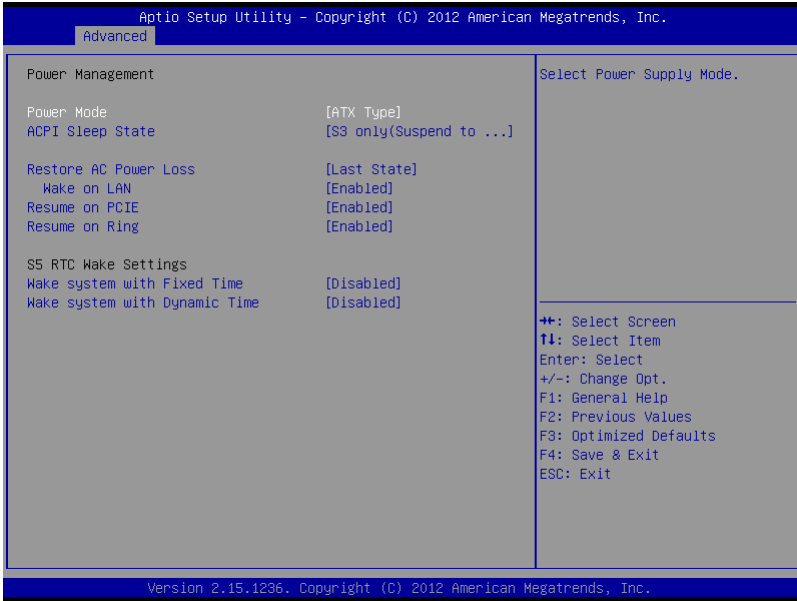

Options summary:

<b>Power Mode</b>	ATX Type	Optimal Default, Failsafe Default
	AT Type	
Select power supply mode.		
<b>ACPI Sleep State</b>	Suspend Disabled	Optimal Default, Failsafe Default
	S3 only(Suspend to RAM)	
Select ACPI sleep state the system will enter when the SUSPEND button is pressed.		
<b>Restore on Power Loss</b>	Power Off	Optimal Default, Failsafe Default
	Power On	
	Last State	
Select power state when power is re-applied after a power failure.		
<b>Wake on LAN</b>	Enabled	Optimal Default, Failsafe Default
	Disabled	
Enable or disable integrated LAN to wake the system. (The wake On LAN cannot be disabled if ME is on at Sx state.)		
<b>Resume on PCIE</b>	Disabled	Optimal Default, Failsafe Default
	Enabled	
Enable/Disable Resume from PCIE signal		

<b>Resume on Ring</b>	Disabled	Optimal Default, Failsafe Default
	Enabled	
Enable/Disable Resume from RI# signal		
<b>RTC wake system from S5</b>	Disabled	Optimal Default, Failsafe Default
	Fixed Time	
	Dynamic Time	
Enable or disable System wake on alarm event. When enabled, System will wake on the hr::min::sec specified		

### 3.4.4 Advanced: CPU Configuration

Aptio Setup Utility - Copyright (C) 2012 American Megatrends, Inc.

Advanced

Intel(R) Core(TM) i3-4110E CPU @ 2.60GHz		When enabled, a VMM can utilize the additional hardware capabilities provided by Vanderpool Technology
CPU Signature	306c3	
Processor Family	6	
Microcode Patch	1d	
FSB Speed	100 MHz	
Max CPU Speed	2600 MHz	
Min CPU Speed	800 MHz	
CPU Speed	2600 MHz	
Processor Cores	2	
Intel HT Technology	Supported	
Intel VT-x Technology	Supported	
Intel SMX Technology	Not Supported	
64-bit	Supported	
EIST Technology	Supported	
CPU C3 state	Supported	
CPU C6 state	Supported	
CPU C7 state	Supported	
L1 Data Cache	32 KB x 2	
L1 Code Cache	32 KB x 2	
L2 Cache	256 KB x 2	
L3 Cache	3072 KB	
Hyper-threading	[Enabled]	
Intel Virtualization Technology	[Enabled]	

Version 2.15.1236. Copyright (C) 2012 American Megatrends, Inc.

Aptio Setup Utility - Copyright (C) 2012 American Megatrends, Inc.

Advanced

CPU Signature	306c3	Turbo Mode.
Processor Family	6	
Microcode Patch	1d	
FSB Speed	100 MHz	
Max CPU Speed	1600 MHz	
Min CPU Speed	800 MHz	
CPU Speed	2600 MHz	
Processor Cores	2	
Intel HT Technology	Supported	
Intel VT-x Technology	Supported	
Intel SMX Technology	Supported	
64-bit	Supported	
EIST Technology	Supported	
CPU C3 state	Supported	
CPU C6 state	Supported	
CPU C7 state	Supported	
L1 Data Cache	32 KB x 2	
L1 Code Cache	32 KB x 2	
L2 Cache	256 KB x 2	
L3 Cache	3072 KB	
Hyper-threading	[Enabled]	
Intel Virtualization Technology	[Enabled]	
Turbo Mode	[Enabled]	

Version 2.15.1236. Copyright (C) 2012 American Megatrends, Inc.

Options summary:

<b>Hyper-threading</b>	Disabled	
	Enabled	Optimal Default, Failsafe Default
Enabled for Windows XP and Linux (OS optimized for Hyper-Threading Technology) and Disabled for other OS (OS not optimized for Hyper-Threading Technology). When Disabled only one thread per enabled core is enabled.		
<b>Intel Virtualization Technology</b>	Disabled	
	Enabled	Optimal Default, Failsafe Default
When enabled, a VMM can utilize the additional hardware capabilities provided by Vanderpool Technology		
<b>Turbo Mode</b>	Disable	
	Enable	Optimal Default, Failsafe Default
Turbo Mode.		



### 3.4.5 Advanced: AMT Configuration

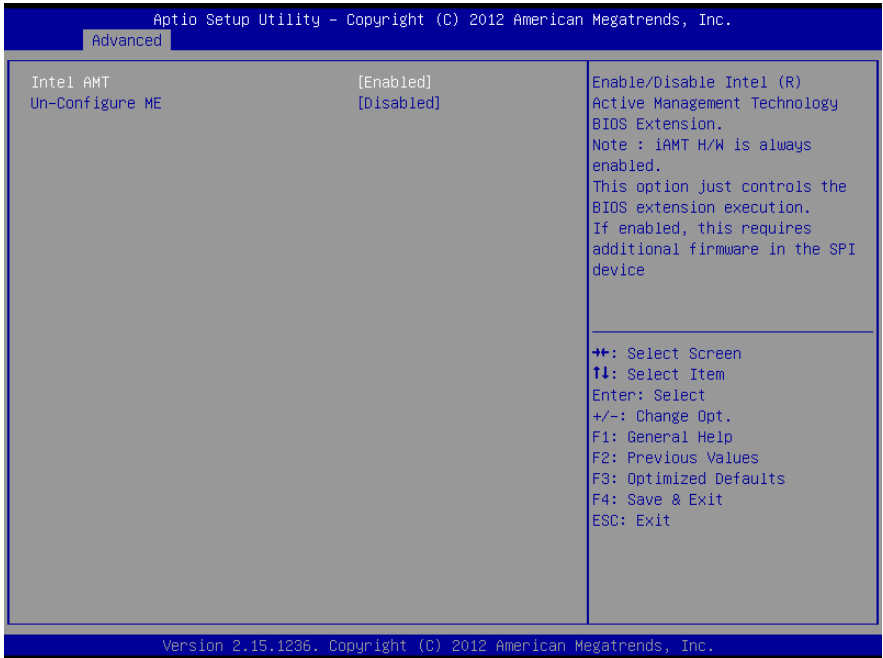

Options summary:

<b>Intel AMT</b>	Disabled	
	Enabled	Optimal Default, Failsafe Default
Enable/Disable Intel (R) Active Management Technology BIOS Extension. Note : iAMT H/W is always enabled. This option just controls the BIOS extension execution. If enabled, this requires additional firmware in the SPI device		
<b>Un-Configure ME</b>	Disabled	Optimal Default, Failsafe Default
	Enabled	
OEMFlag Bit 15:Un-Configure ME without password.		

### 3.4.6 Advanced: Trusted Computing

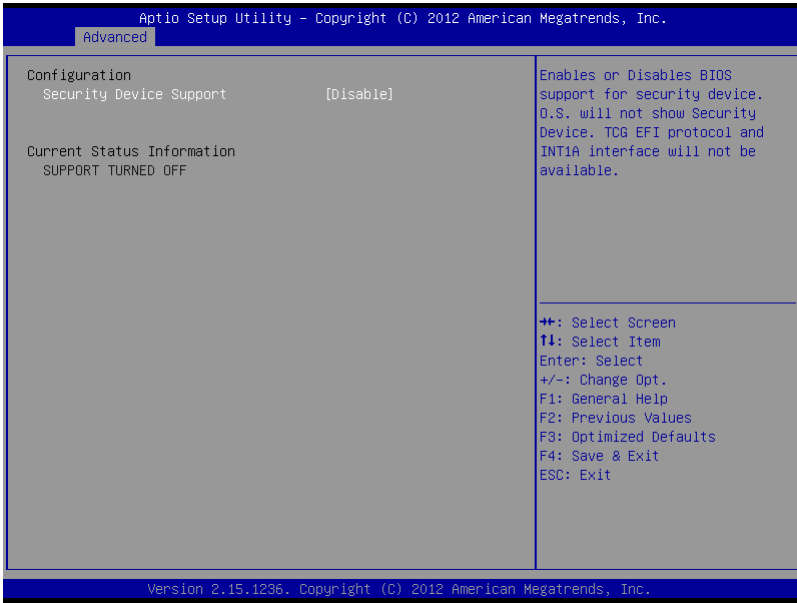

Options summary:

<b>Security Device Support</b>	Disabled	Optimal Default, Failsafe Default
	Enabled	
Enables or Disables BIOS support for security device. O.S. will not show Security Device. TCG EFI protocol and INT1A interface will not be available.		

### 3.4.7 Advanced: SATA Configuration

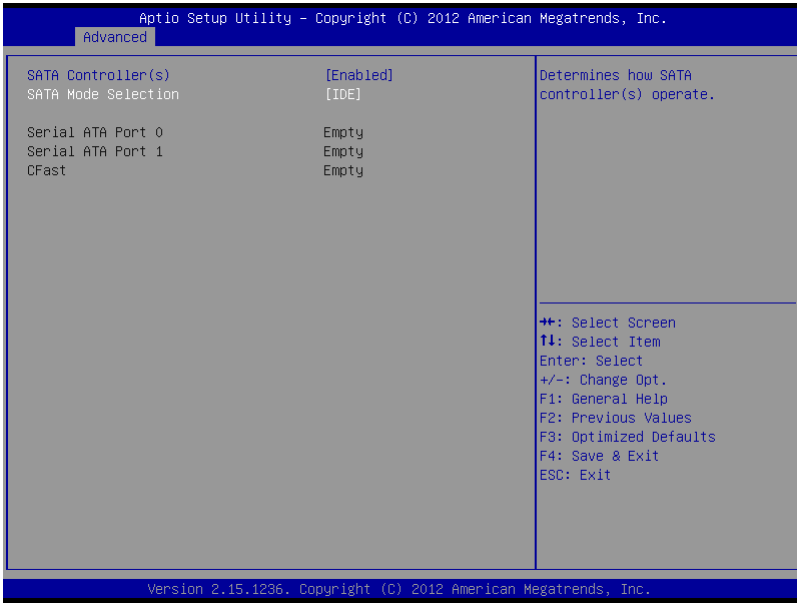

Options summary:

SATA controller(s)	Enabled	Optimal Default, Failsafe Default
	Disabled	
Enable or disable SATA Device.		
SATA Mode Selection	IDE	Optimal Default, Failsafe Default
	AHCI	
Determines how SATA controller(s) operate.		

### 3.4.8 Advanced: USB Configuration

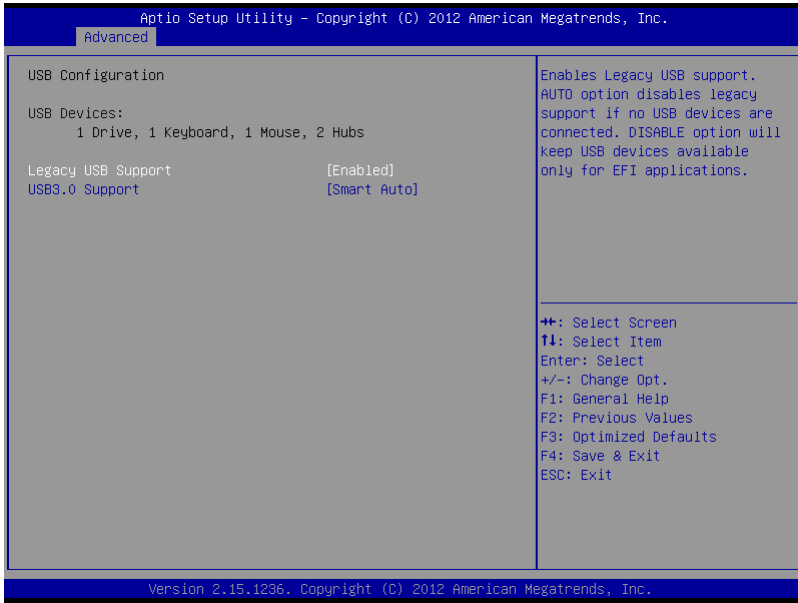

Options summary:

Legacy USB Support	Enabled	Optimal Default, Failsafe Default
	Disabled	
	Auto	
Enables Legacy USB support. AUTO option disables legacy support if no USB devices are connected. DISABLE option will keep USB devices available only for EFI applications.		
USB3.0 Support	Smart Auto	Optimal Default, Failsafe Default
	Enabled	
	Disabled	
Mode of operation of xHCI controller.		

### 3.4.9 Advanced: Dynamic Digital IO

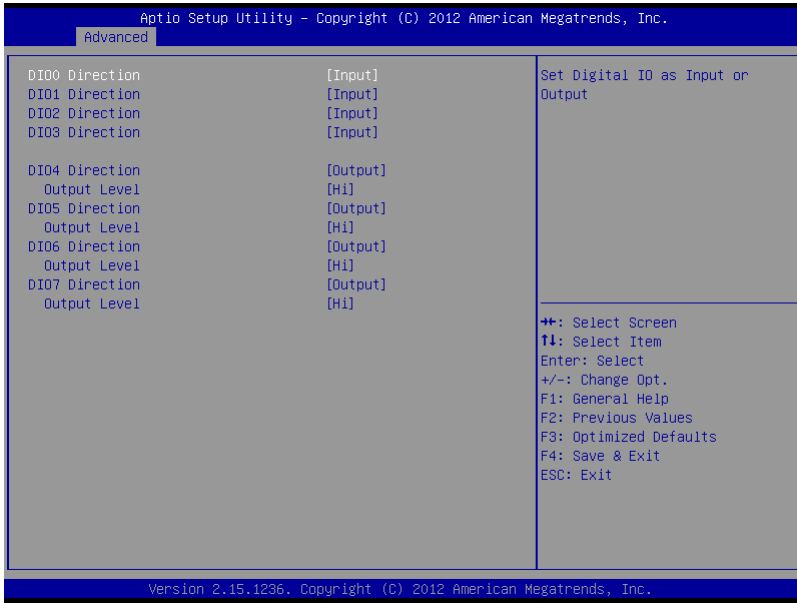

Options summary:

DIO[3:0] Direction	Input	Optimal Default, Failsafe Default
	Output	
Set Digital IO as Input or Output		
DIO[7:4] Direction	Input	
	Output	Optimal Default, Failsafe Default
Set Digital IO as Input or Output		
DIO[3:0] Output Level	Hi	Optimal Default, Failsafe Default
	Low	
Set Digital IO Output as Hi or Low		

### 3.5 Setup submenu: Chipset

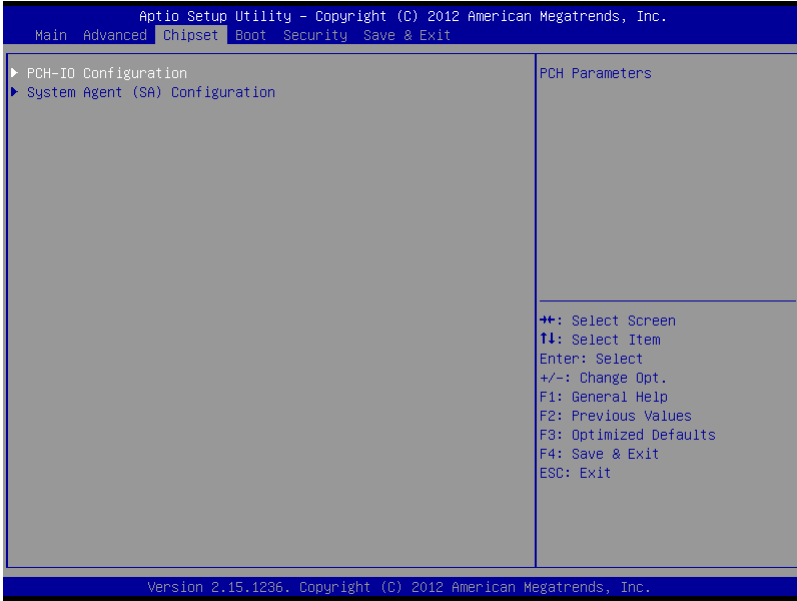

### 3.5.1 Chipset: PCH-IO Configuration

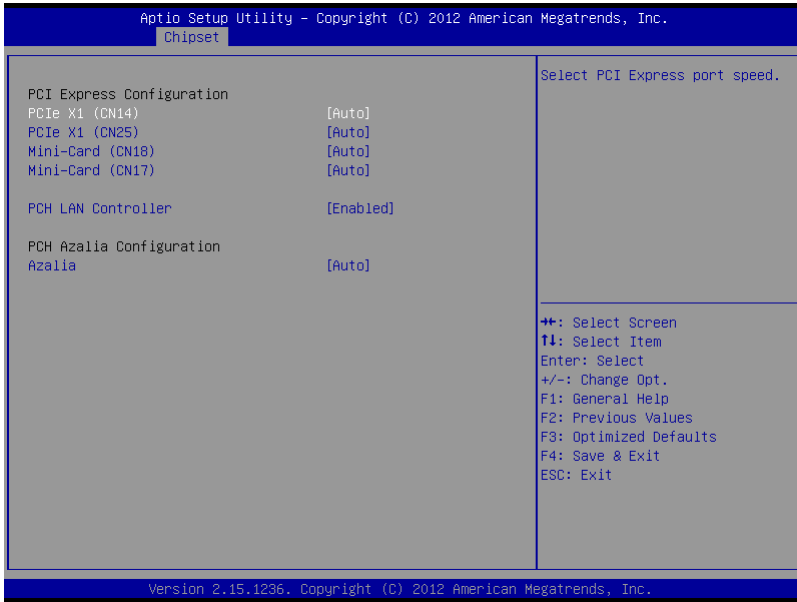

Options summary:

PCIe X1 (CN14)	Auto	Optimal Default, Failsafe Default
	Gen1	
	Gen2	
Select PCI Express X1 (CN14) port speed.		
PCIe X1 (CN25)	Auto	Optimal Default, Failsafe Default
	Gen1	
	Gen2	
Select PCI Express X1 (CN25) port speed.		
Mini-Card (CN18)	Auto	Optimal Default, Failsafe Default
	Gen1	
	Gen2	
Select Mini-Card (CN18) port speed.		
Mini-Card (CN17)	Auto	Optimal Default, Failsafe Default
	Gen1	
	Gen2	
Select Mini-Card (CN17) port speed.		
PCH LAN Controller	Enabled	Optimal Default, Failsafe Default
	Disabled	

Enable or disable onboard NIC.		
<b>Azalia</b>	Disabled	
	Enabled	
	Auto	Optimal Default, Failsafe Default
Control Detection of the Azalia device Disabled = Azalia will be unconditionally disabled Enabled = Azalia will be unconditionally Enabled Auto = Azalia will be enabled if present, disabled otherwise.		



### 3.5.2 Chipset: System Agent (SA) Configuration

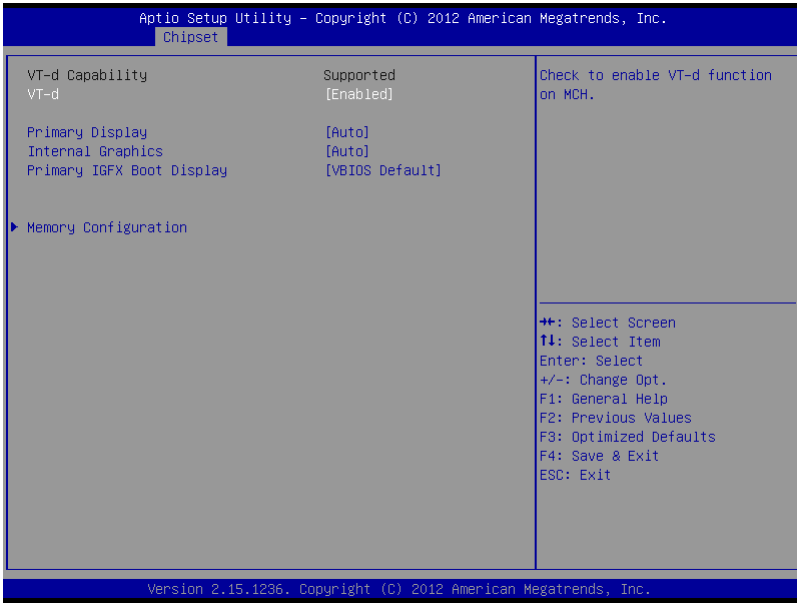

Options summary:

<b>Primary Display</b>	Auto	Optimal Default, Failsafe Default
	IGFX	
	PEG	
	PCIE	
Select which of IGFX/PEG/PCI Graphics device should be Primary Display.		
<b>Internal Graphics</b>	Auto	Optimal Default, Failsafe Default
	Disabled	
	Enabled	
Keep IGD enabled based on the setup options.		
<b>Primary IGFX Boot Display</b>	VBIOS Default	Optimal Default, Failsafe Default
	CRT	
	HDMI	
	DVI	
<b>Secondary IGFX Boot Display</b>	Disabled	Optimal Default, Failsafe Default
	CRT	
	HDMI	
	DVI	
Select Secondary Display Device		

### 3.5.2.1 System Agent (SA) Configuration: Memory Configuration

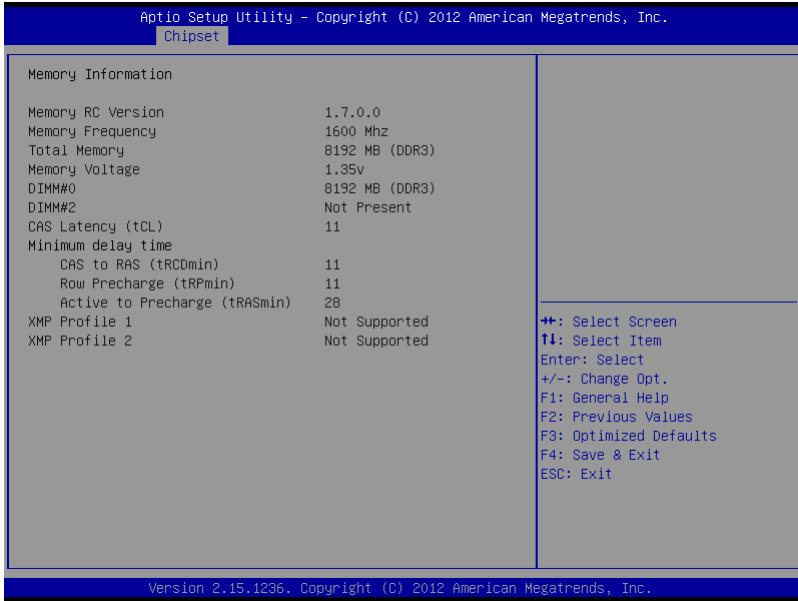

### 3.6 Setup submenu: Boot

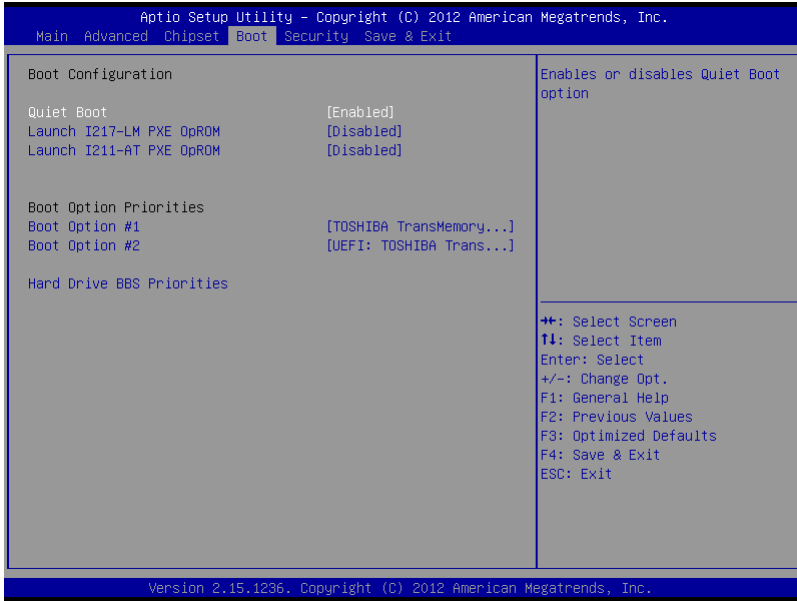

Options summary:

Quiet Boot	Disabled	
	Enabled	Default
En/Disable showing boot logo.		
Launch I217-LM PXE OpROM	Disabled	Default
	Enabled	
Enable or Disable Legacy Boot Option for I217-LM.		
Launch I211-AT PXE OpROM	Disabled	Default
	Enabled	
Enable or Disable Legacy Boot Option for I211-AT.		

### 3.6.1 Boot: BBS Priorities

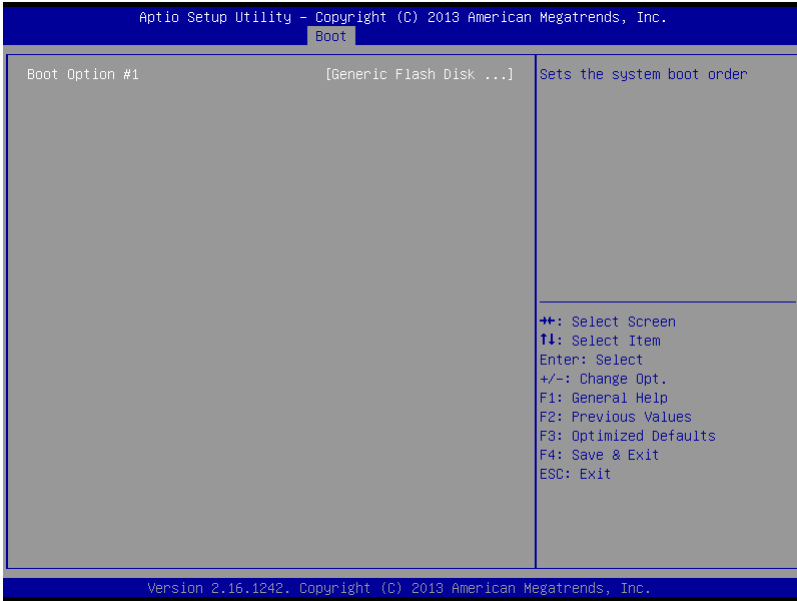

## 3.7 Setup submenu: Security

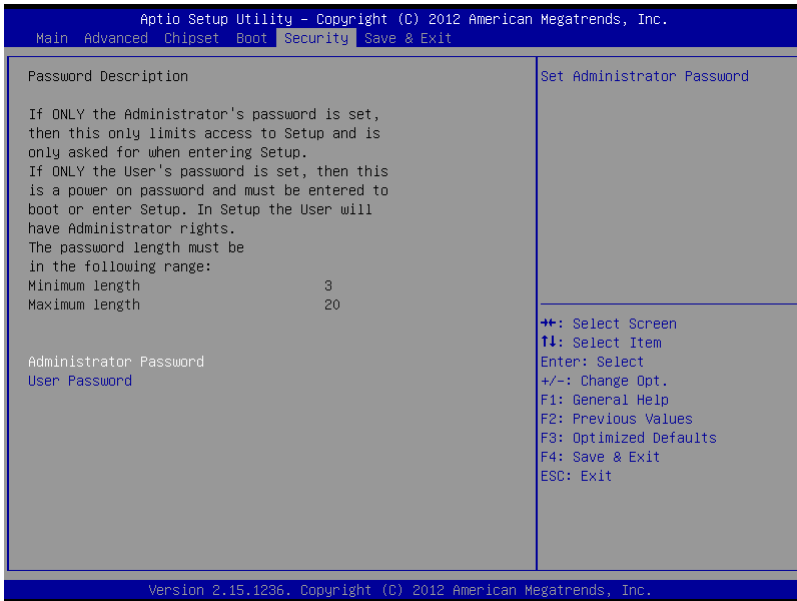

### Change User/Administrator Password

You can set a User Password once an Administrator Password is set. The password will be required during boot up, or when the user enters the Setup utility. Please Note that a User Password does not provide access to many of the features in the Setup utility.

Select the password you wish to set, press Enter to open a dialog box to enter your password (you can enter no more than six letters or numbers). Press Enter to confirm your entry, after which you will be prompted to retype your password for a final confirmation. Press Enter again after you have retyped it correctly.

### Removing the Password

Highlight this item and type in the current password. At the next dialog box press Enter to disable password protection.

### 3.8 Setup submenu: Save & Exit

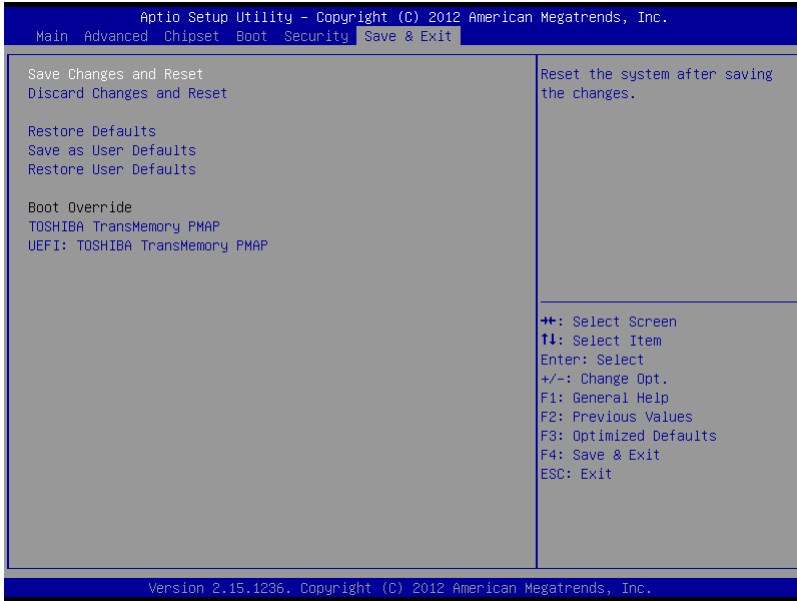

# Chapter 4

---

Drivers Installation

## 4.1 Product CD/DVD

---

The BOXER-6652 comes with a product CD that contains all the drivers and utilities you need to setup your product. Insert the CD and follow the steps in the autorun program to install the drivers.

In case the program does not start, follow the sequence below to install the drivers.

### Step 1 – Install Chipset Driver

1. Open the **Step1 - INF** folder followed by **SetupChipset.exe**
2. Follow the instructions
3. Drivers will be installed automatically

### Step 2 – Install Graphics Driver

1. Open the **Step2 - Graphic** folder and select your OS
2. Open the **.exe** file in the folder
3. Follow the instructions
4. Drivers will be installed automatically

### Step 3 – Install USB3.0 Driver (Windows 7 only)

1. Open the **Step3 - USB3.0** folder followed by **Setup.exe**
2. Follow the instructions
3. Drivers will be installed automatically

### Step 4 – Install Audio Driver

1. Open the **Step4 - Audio** folder followed by **0005-Win7\_Win8\_Win81\_Win10\_R279.exe**
2. Follow the instructions
3. Drivers will be installed automatically



### Step 5 – Install LAN Driver

1. Open the **Step5 - LAN** folder and select your OS
2. Open the **.exe** file in the folder
3. Follow the instructions
4. Drivers will be installed automatically

### Step 6 – Install RAID\_AHCI Driver

1. Open the **Step6 - RAID\_AHCI** folder followed by **SetupRST.exe**
2. Follow the instructions
3. Drivers will be installed automatically

### Step 7 – Install ME Driver

1. Open the **Step7 - ME** folder followed by **SetupME.exe**
2. Follow the instructions
3. Drivers will be installed automatically

### Step 8 – Install UART Drivers (Optional)

1. Open the **Step8 - UART (Optional)** folder followed by **setup.exe**
2. Follow the instructions
3. Drivers will be installed automatically

# Appendix A

---

## Watchdog Timer Programming

## A.1 Watchdog Timer Initial Program

Table 1 : SuperIO relative register table

	Default Value	Note
Index	0x2E(Note1)	SIO MB PnP Mode Index Register 0x2E or 0x4E
Data	0x2F(Note2)	SIO MB PnP Mode Data Register 0x2F or 0x4F

Table 2 : Watchdog relative register table

	LDN	Register	BitNum	Value	Note
Timer Counter	0x07(Note3)	0xF6(Note4)		(Note24)	Time of watchdog timer (0~255) This register is byte access
Counting Unit	0x07(Note5)	0xF5(Note6)	3(Note7)	0(Note8)	Select time unit. 0: second 1: minute
Watchdog Enable	0x07(Note9)	0xF5(Note10)	5(Note11)	1(Note12)	0: Disable 1: Enable
Timeout Status	0x07(Note13)	0xF5(Note14)	6(Note15)	1	1: Clear timeout status
Output Mode	0x07(Note16)	0xF5(Note17)	4(Note18)	1(Note19)	Select WDTRST# output mode 0: level 1: pulse
WDTRST output	0x07(Note20)	0xFA(Note21)	0(Note22)	1(Note23)	Enable/Disable time out output via WDTRST# 0: Disable 1: Enable

```

*****
// SuperIO relative definition (Please reference to Table 1)
#define byte   SIOIndex   //This parameter is represented from Note1
#define byte   SIOData    //This parameter is represented from Note2
#define void   IOWriteByte(byte IOPort, byte Value);
#define byte   IOReadByte(byte IOPort);
// Watch Dog relative definition (Please reference to Table 2)
#define byte   TimerLDN   //This parameter is represented from Note3
#define byte   TimerReg   //This parameter is represented from Note4
#define byte   TimerVal   // This parameter is represented from Note24
#define byte   UnitLDN    //This parameter is represented from Note5
#define byte   UnitReg    //This parameter is represented from Note6
#define byte   UnitBit    //This parameter is represented from Note7
#define byte   UnitVal    //This parameter is represented from Note8
#define byte   EnableLDN //This parameter is represented from Note9
#define byte   EnableReg //This parameter is represented from Note10
#define byte   EnableBit //This parameter is represented from Note11
#define byte   EnableVal //This parameter is represented from Note12
#define byte   StatusLDN // This parameter is represented from Note13
#define byte   StatusReg // This parameter is represented from Note14
#define byte   StatusBit // This parameter is represented from Note15
#define byte   ModeLDN   // This parameter is represented from Note16
#define byte   ModeReg   // This parameter is represented from Note17
#define byte   ModeBit   // This parameter is represented from Note18
#define byte   ModeVal   // This parameter is represented from Note19
#define byte   WDTRstLDN // This parameter is represented from Note20
#define byte   WDTRstReg // This parameter is represented from Note21
#define byte   WDTRstBit // This parameter is represented from Note22
#define byte   WDTRstVal // This parameter is represented from Note23
*****

```

```
*****  
VOID Main()  
    // Procedure : AaeonWDTConfig  
    // (byte)Timer : Time of WDT timer.(0x00~0xFF)  
    // (boolean)Unit : Select time unit(0: second, 1: minute).  
    AaeonWDTConfig();  
  
    // Procedure : AaeonWDTEnable  
    // This procedure will enable the WDT counting.  
    AaeonWDTEnable();  
}  
*****
```

```

*****
// Procedure : AaeonWDTEnable
VOID  AaeonWDTEnable (){
    WDTEnableDisable(EnableLDN, EnableReg, EnableBit, 1);
}

// Procedure : AaeonWDTConfig
VOID  AaeonWDTConfig (){
    // Disable WDT counting
    WDTEnableDisable(EnableLDN, EnableReg, EnableBit, 0);
    // Clear Watchdog Timeout Status
    WDTClearTimeoutStatus();
    // WDT relative parameter setting
    WDTParameterSetting();
}

VOID  WDTEnableDisable(byte LDN, byte Register, byte BitNum, byte Value){
    SIOBitSet(LDN, Register, BitNum, Value);
}

VOID  WDTParameterSetting(){
    // Watchdog Timer counter setting
    SIOByteSet(TimerLDN, TimerReg, TimerVal);
    // WDT counting unit setting
    SIOBitSet(UnitLDN, UnitReg, UnitBit, UnitVal);
    // WDT output mode setting, level / pulse
    SIOBitSet(ModelLDN, ModeReg, ModeBit, ModeVal);
    // Watchdog timeout output via WDTRST#
    SIOBitSet(WDTRstLDN, WDTRstReg, WDTRstBit, WDTRstVal);
}

VOID  WDTClearTimeoutStatus(){
    SIOBitSet(StatusLDN, StatusReg, StatusBit, 1);
}
*****

```

```

*****
VOID  SIOEnterMBPnPMode(){
    IOWriteByte(SIOIndex, 0x87);
    IOWriteByte(SIOIndex, 0x87);
}

VOID  SIOExitMBPnPMode(){
    IOWriteByte(SIOIndex, 0xAA);
}

VOID  SIOSelectLDN(byte LDN){
    IOWriteByte(SIOIndex, 0x07); // SIO LDN Register Offset = 0x07
    IOWriteByte(SIOData, LDN);
}

VOID  SIOBitSet(byte LDN, byte Register, byte BitNum, byte Value){
    Byte TmpValue;

    SIOEnterMBPnPMode();
    SIOSelectLDN(byte LDN);
    IOWriteByte(SIOIndex, Register);
    TmpValue = IOReadByte(SIOData);
    TmpValue &= ~(1 << BitNum);
    TmpValue |= (Value << BitNum);
    IOWriteByte(SIOData, TmpValue);
    SIOExitMBPnPMode();
}

VOID  SIOByteSet(byte LDN, byte Register, byte Value){
    SIOEnterMBPnPMode();
    SIOSelectLDN(LDN);
    IOWriteByte(SIOIndex, Register);
    IOWriteByte(SIOData, Value);
    SIOExitMBPnPMode();
}
*****

```

# Appendix B

---







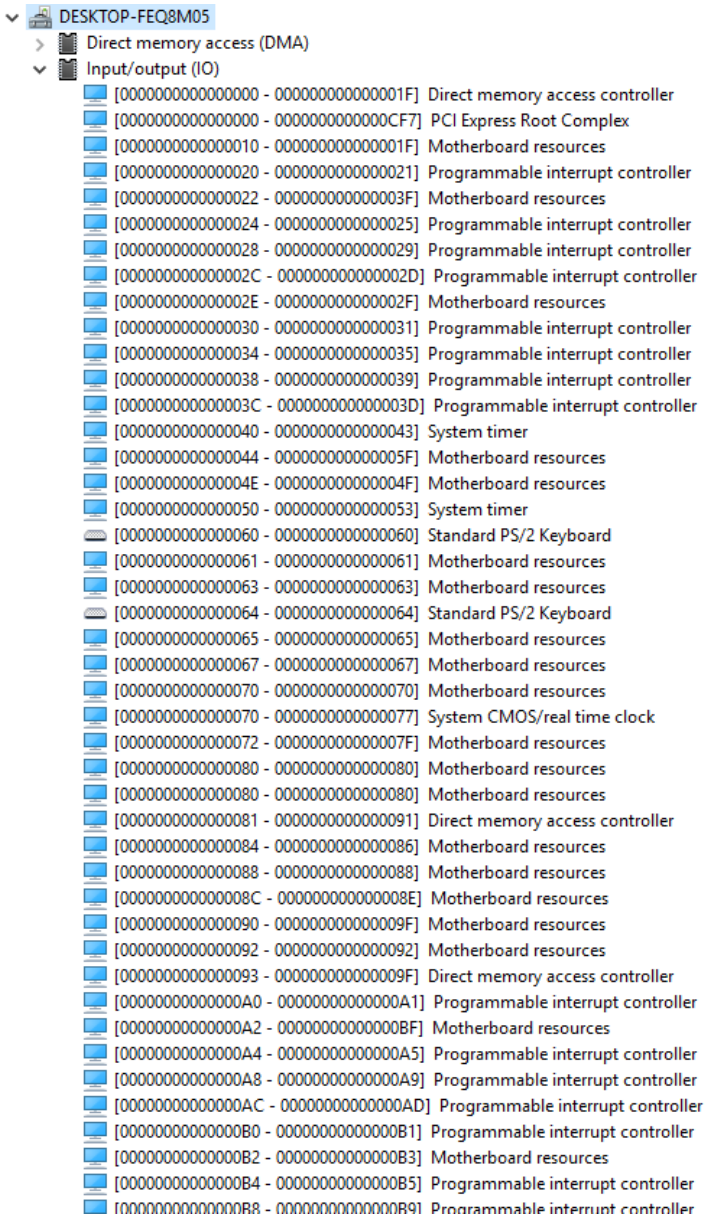







































I/O Information



## B.1 I/O Address Map



Address Range	Description
[0000000000000000 - 000000000000001F]	Direct memory access controller
[0000000000000000 - 000000000000CF7]	PCI Express Root Complex
[0000000000000010 - 000000000000001F]	Motherboard resources
[0000000000000020 - 0000000000000021]	Programmable interrupt controller
[0000000000000022 - 000000000000003F]	Motherboard resources
[0000000000000024 - 0000000000000025]	Programmable interrupt controller
[0000000000000028 - 0000000000000029]	Programmable interrupt controller
[000000000000002C - 000000000000002D]	Programmable interrupt controller
[000000000000002E - 000000000000002F]	Motherboard resources
[0000000000000030 - 0000000000000031]	Programmable interrupt controller
[0000000000000034 - 0000000000000035]	Programmable interrupt controller
[0000000000000038 - 0000000000000039]	Programmable interrupt controller
[000000000000003C - 000000000000003D]	Programmable interrupt controller
[0000000000000040 - 0000000000000043]	System timer
[0000000000000044 - 000000000000005F]	Motherboard resources
[000000000000004E - 000000000000004F]	Motherboard resources
[0000000000000050 - 0000000000000053]	System timer
[0000000000000060 - 0000000000000060]	Standard PS/2 Keyboard
[0000000000000061 - 0000000000000061]	Motherboard resources
[0000000000000063 - 0000000000000063]	Motherboard resources
[0000000000000064 - 0000000000000064]	Standard PS/2 Keyboard
[0000000000000065 - 0000000000000065]	Motherboard resources
[0000000000000067 - 0000000000000067]	Motherboard resources
[0000000000000070 - 0000000000000070]	Motherboard resources
[0000000000000070 - 0000000000000077]	System CMOS/real time clock
[0000000000000072 - 000000000000007F]	Motherboard resources
[0000000000000080 - 0000000000000080]	Motherboard resources
[0000000000000080 - 0000000000000080]	Motherboard resources
[0000000000000081 - 0000000000000091]	Direct memory access controller
[0000000000000084 - 0000000000000086]	Motherboard resources
[0000000000000088 - 0000000000000088]	Motherboard resources
[000000000000008C - 000000000000008E]	Motherboard resources
[0000000000000090 - 000000000000009F]	Motherboard resources
[0000000000000092 - 0000000000000092]	Motherboard resources
[0000000000000093 - 000000000000009F]	Direct memory access controller
[00000000000000A0 - 00000000000000A1]	Programmable interrupt controller
[00000000000000A2 - 00000000000000BF]	Motherboard resources
[00000000000000A4 - 00000000000000A5]	Programmable interrupt controller
[00000000000000A8 - 00000000000000A9]	Programmable interrupt controller
[00000000000000AC - 00000000000000AD]	Programmable interrupt controller
[00000000000000B0 - 00000000000000B1]	Programmable interrupt controller
[00000000000000B2 - 00000000000000B3]	Motherboard resources
[00000000000000B4 - 00000000000000B5]	Programmable interrupt controller
[00000000000000B8 - 00000000000000B9]	Programmable interrupt controller















































	[000000000000AC - 000000000000AD] Programmable interrupt controller
	[000000000000B0 - 000000000000B1] Programmable interrupt controller
	[000000000000B2 - 000000000000B3] Motherboard resources
	[000000000000B4 - 000000000000B5] Programmable interrupt controller
	[000000000000B8 - 000000000000B9] Programmable interrupt controller
	[000000000000BC - 000000000000BD] Programmable interrupt controller
	[000000000000C0 - 000000000000DF] Direct memory access controller
	[000000000000E0 - 000000000000EF] Motherboard resources
	[000000000000F0 - 000000000000F0] Numeric data processor
	[000000000000290 - 00000000000029F] Motherboard resources
	[0000000000002C0 - 0000000000002C7] Fintek Communications Port (COM6)
	[0000000000002D0 - 0000000000002D7] Fintek Communications Port (COM5)
	[0000000000002E8 - 0000000000002EF] Fintek Communications Port (COM4)
	[0000000000002F8 - 0000000000002FF] Fintek Communications Port (COM2)
	[0000000000003B0 - 0000000000003BB] Intel(R) HD Graphics 4600
	[0000000000003C0 - 0000000000003DF] Intel(R) HD Graphics 4600
	[0000000000003E8 - 0000000000003EF] Fintek Communications Port (COM3)
	[0000000000003F8 - 0000000000003FF] Fintek Communications Port (COM1)
	[0000000000004D0 - 0000000000004D1] Motherboard resources
	[0000000000004D0 - 0000000000004D1] Programmable interrupt controller
	[000000000000680 - 00000000000069F] Motherboard resources
	[000000000000A00 - 000000000000A0F] Motherboard resources
	[000000000000A10 - 000000000000A1F] Motherboard resources
	[000000000000D00 - 000000000000FFF] PCI Express Root Complex
	[000000000000164E - 000000000000164F] Motherboard resources
	[0000000000001800 - 00000000000018FE] Motherboard resources
	[0000000000001854 - 0000000000001857] Motherboard resources
	[0000000000001C00 - 0000000000001CFE] Motherboard resources
	[0000000000001D00 - 0000000000001DFE] Motherboard resources
	[0000000000001E00 - 0000000000001EFE] Motherboard resources
	[0000000000001F00 - 0000000000001FFE] Motherboard resources
	[000000000000E000 - 000000000000EFFF] Intel(R) 8 Series/C220 Series PCI Express Root Port #8 - 8C1E
	[000000000000F000 - 000000000000F03F] Intel(R) HD Graphics 4600
	[000000000000F040 - 000000000000F05F] Intel(R) 8 Series/C220 Series SMBus Controller - 8C22
	[000000000000F080 - 000000000000F08F] Standard Dual Channel PCI IDE Controller
	[000000000000F090 - 000000000000F09F] Standard Dual Channel PCI IDE Controller
	[000000000000F0A0 - 000000000000F0A3] Standard Dual Channel PCI IDE Controller
	[000000000000F0B0 - 000000000000F0B7] Standard Dual Channel PCI IDE Controller
	[000000000000F0C0 - 000000000000F0C3] Standard Dual Channel PCI IDE Controller
	[000000000000F0D0 - 000000000000F0D7] Standard Dual Channel PCI IDE Controller
	[000000000000F0E0 - 000000000000F0E7] Intel(R) Active Management Technology - SOL (COM7)
	[000000000000FFFF - 000000000000FFFF] Motherboard resources
	[000000000000FFFF - 000000000000FFFF] Motherboard resources
	[000000000000FFFF - 000000000000FFFF] Motherboard resources
	Interrupt request (IRQ)
	Memory















































## B.2 Memory Address Map















































DESKTOP-FEQ8M05















































- > Direct memory access (DMA)
- > Input/output (I/O)
- > Interrupt request (IRQ)
- Memory
  - [0000000000A0000 - 0000000000BFFFF] Intel(R) HD Graphics 4600
  - [0000000000A0000 - 0000000000BFFFF] PCI Express Root Complex
  - [0000000000D0000 - 0000000000D3FFF] PCI Express Root Complex
  - [0000000000D4000 - 0000000000D7FFF] PCI Express Root Complex
  - [0000000000D8000 - 0000000000DBFFF] PCI Express Root Complex
  - [0000000000DC000 - 0000000000DFFFF] PCI Express Root Complex
  - [0000000000E0000 - 0000000000E3FFF] PCI Express Root Complex
  - [0000000000E4000 - 0000000000E7FFF] PCI Express Root Complex
  - [00000000DF20000 - 00000000FEAFFFF] PCI Express Root Complex
  - [00000000E000000 - 00000000EFFFFFF] Intel(R) HD Graphics 4600
  - [00000000F780000 - 00000000F7BFFFF] Intel(R) HD Graphics 4600
  - [00000000F7C0000 - 00000000F7C1FFF] Intel(R) I211 Gigabit Network Connection
  - [00000000F7C0000 - 00000000F7CFFFF] Intel(R) 8 Series/C220 Series PCI Express Root Port #8 - 8C1E
  - [00000000F7C2000 - 00000000F7C23FFF] Intel(R) I211 Gigabit Network Connection
  - [00000000F7D0000 - 00000000F7D1FFF] Intel(R) Ethernet Connection I217-LM
  - [00000000F7D20000 - 00000000F7D2FFFF] Intel(R) USB 3.0 eXtensible Host Controller - 1.0 (Microsoft)
  - [00000000F7D30000 - 00000000F7D33FFF] High Definition Audio Controller
  - [00000000F7D34000 - 00000000F7D37FFF] High Definition Audio Controller
  - [00000000F7D39000 - 00000000F7D390FF] Intel(R) 8 Series/C220 Series SMBus Controller - 8C22
  - [00000000F7D3A000 - 00000000F7D3A3FF] Intel(R) 8 Series/C220 Series USB EHCI #1 - 8C26
  - [00000000F7D3B000 - 00000000F7D3B3FF] Intel(R) 8 Series/C220 Series USB EHCI #2 - 8C2D
  - [00000000F7D3C000 - 00000000F7D3CFFF] Intel(R) Ethernet Connection I217-LM
  - [00000000F7D3F000 - 00000000F7D3F0FF] Intel(R) Management Engine Interface
  - [00000000F7DF000 - 00000000F7DFDFFF] Motherboard resources
  - [00000000F7FE0000 - 00000000F7FEFFFF] Motherboard resources
  - [00000000F8000000 - 00000000FBFFFFFF] Motherboard resources
  - [00000000FED00000 - 00000000FED003FF] High precision event timer
  - [00000000FED10000 - 00000000FED17FFF] Motherboard resources
  - [00000000FED18000 - 00000000FED18FFF] Motherboard resources
  - [00000000FED19000 - 00000000FED19FFF] Motherboard resources
  - [00000000FED1C000 - 00000000FED1FFFF] Motherboard resources
  - [00000000FED20000 - 00000000FED3FFFF] Motherboard resources
  - [00000000FED40000 - 00000000FED44FFF] System board
  - [00000000FED45000 - 00000000FED89FFF] Motherboard resources
  - [00000000FED90000 - 00000000FED93FFF] Motherboard resources
  - [00000000FEE00000 - 00000000FEEFFFFFF] Motherboard resources
  - [00000000FF000000 - 00000000FFFFFFFF] Legacy device
  - [00000000FF000000 - 00000000FFFFFFFF] Motherboard resources















































## B.3 IRQ Mapping Chart

▼		Interrupt request (IRQ)	
		(ISA) 0x00000000 (00)	System timer
		(ISA) 0x00000001 (01)	Standard PS/2 Keyboard
		(ISA) 0x00000003 (03)	Fintek Communications Port (COM2)
		(ISA) 0x00000004 (04)	Fintek Communications Port (COM1)
		(ISA) 0x00000008 (08)	System CMOS/real time clock
		(ISA) 0x0000000A (10)	Fintek Communications Port (COM3)
		(ISA) 0x0000000A (10)	Fintek Communications Port (COM4)
		(ISA) 0x0000000A (10)	Fintek Communications Port (COM5)
		(ISA) 0x0000000A (10)	Fintek Communications Port (COM6)
		(ISA) 0x0000000B (11)	High Definition Audio Controller
		(ISA) 0x0000000C (12)	Microsoft PS/2 Mouse
		(ISA) 0x0000000D (13)	Numeric data processor
		(ISA) 0x00000036 (54)	Microsoft ACPI-Compliant System
		(ISA) 0x00000037 (55)	Microsoft ACPI-Compliant System
		(ISA) 0x00000038 (56)	Microsoft ACPI-Compliant System
		(ISA) 0x00000039 (57)	Microsoft ACPI-Compliant System
		(ISA) 0x0000003A (58)	Microsoft ACPI-Compliant System
		(ISA) 0x0000003B (59)	Microsoft ACPI-Compliant System
		(ISA) 0x0000003C (60)	Microsoft ACPI-Compliant System
		(ISA) 0x0000003D (61)	Microsoft ACPI-Compliant System
		(ISA) 0x0000003E (62)	Microsoft ACPI-Compliant System
		(ISA) 0x0000003F (63)	Microsoft ACPI-Compliant System
		(ISA) 0x00000040 (64)	Microsoft ACPI-Compliant System
		(ISA) 0x00000041 (65)	Microsoft ACPI-Compliant System
		(ISA) 0x00000042 (66)	Microsoft ACPI-Compliant System
		(ISA) 0x00000043 (67)	Microsoft ACPI-Compliant System
		(ISA) 0x00000044 (68)	Microsoft ACPI-Compliant System
		(ISA) 0x00000045 (69)	Microsoft ACPI-Compliant System
		(ISA) 0x00000046 (70)	Microsoft ACPI-Compliant System
		(ISA) 0x00000047 (71)	Microsoft ACPI-Compliant System
		(ISA) 0x00000048 (72)	Microsoft ACPI-Compliant System
		(ISA) 0x00000049 (73)	Microsoft ACPI-Compliant System
		(ISA) 0x0000004A (74)	Microsoft ACPI-Compliant System
		(ISA) 0x0000004B (75)	Microsoft ACPI-Compliant System
		(ISA) 0x0000004C (76)	Microsoft ACPI-Compliant System
		(ISA) 0x0000004D (77)	Microsoft ACPI-Compliant System
		(ISA) 0x0000004E (78)	Microsoft ACPI-Compliant System
		(ISA) 0x0000004F (79)	Microsoft ACPI-Compliant System
		(ISA) 0x00000050 (80)	Microsoft ACPI-Compliant System
		(ISA) 0x00000051 (81)	Microsoft ACPI-Compliant System
		(ISA) 0x00000052 (82)	Microsoft ACPI-Compliant System
		(ISA) 0x00000053 (83)	Microsoft ACPI-Compliant System
		(ISA) 0x00000054 (84)	Microsoft ACPI-Compliant System
		(ISA) 0x00000055 (85)	Microsoft ACPI-Compliant System
		(ISA) 0x00000056 (86)	Microsoft ACPI-Compliant System
		(ISA) 0x00000057 (87)	Microsoft ACPI-Compliant System















































	(ISA) 0x00000058 (88)	Microsoft ACPI-Compliant System
	(ISA) 0x00000059 (89)	Microsoft ACPI-Compliant System
	(ISA) 0x0000005A (90)	Microsoft ACPI-Compliant System
	(ISA) 0x0000005B (91)	Microsoft ACPI-Compliant System
	(ISA) 0x0000005C (92)	Microsoft ACPI-Compliant System
	(ISA) 0x0000005D (93)	Microsoft ACPI-Compliant System
	(ISA) 0x0000005E (94)	Microsoft ACPI-Compliant System
	(ISA) 0x0000005F (95)	Microsoft ACPI-Compliant System
	(ISA) 0x00000060 (96)	Microsoft ACPI-Compliant System
	(ISA) 0x00000061 (97)	Microsoft ACPI-Compliant System
	(ISA) 0x00000062 (98)	Microsoft ACPI-Compliant System
	(ISA) 0x00000063 (99)	Microsoft ACPI-Compliant System
	(ISA) 0x00000064 (100)	Microsoft ACPI-Compliant System
	(ISA) 0x00000065 (101)	Microsoft ACPI-Compliant System
	(ISA) 0x00000066 (102)	Microsoft ACPI-Compliant System
	(ISA) 0x00000067 (103)	Microsoft ACPI-Compliant System
	(ISA) 0x00000068 (104)	Microsoft ACPI-Compliant System
	(ISA) 0x00000069 (105)	Microsoft ACPI-Compliant System
	(ISA) 0x0000006A (106)	Microsoft ACPI-Compliant System
	(ISA) 0x0000006B (107)	Microsoft ACPI-Compliant System
	(ISA) 0x0000006C (108)	Microsoft ACPI-Compliant System
	(ISA) 0x0000006D (109)	Microsoft ACPI-Compliant System
	(ISA) 0x0000006E (110)	Microsoft ACPI-Compliant System
	(ISA) 0x0000006F (111)	Microsoft ACPI-Compliant System
	(ISA) 0x00000070 (112)	Microsoft ACPI-Compliant System
	(ISA) 0x00000071 (113)	Microsoft ACPI-Compliant System
	(ISA) 0x00000072 (114)	Microsoft ACPI-Compliant System
	(ISA) 0x00000073 (115)	Microsoft ACPI-Compliant System
	(ISA) 0x00000074 (116)	Microsoft ACPI-Compliant System
	(ISA) 0x00000075 (117)	Microsoft ACPI-Compliant System
	(ISA) 0x00000076 (118)	Microsoft ACPI-Compliant System
	(ISA) 0x00000077 (119)	Microsoft ACPI-Compliant System
	(ISA) 0x00000078 (120)	Microsoft ACPI-Compliant System
	(ISA) 0x00000079 (121)	Microsoft ACPI-Compliant System
	(ISA) 0x0000007A (122)	Microsoft ACPI-Compliant System
	(ISA) 0x0000007B (123)	Microsoft ACPI-Compliant System
	(ISA) 0x0000007C (124)	Microsoft ACPI-Compliant System
	(ISA) 0x0000007D (125)	Microsoft ACPI-Compliant System
	(ISA) 0x0000007E (126)	Microsoft ACPI-Compliant System
	(ISA) 0x0000007F (127)	Microsoft ACPI-Compliant System
	(ISA) 0x00000080 (128)	Microsoft ACPI-Compliant System
	(ISA) 0x00000081 (129)	Microsoft ACPI-Compliant System
	(ISA) 0x00000082 (130)	Microsoft ACPI-Compliant System
	(ISA) 0x00000083 (131)	Microsoft ACPI-Compliant System
	(ISA) 0x00000084 (132)	Microsoft ACPI-Compliant System
	(ISA) 0x00000085 (133)	Microsoft ACPI-Compliant System
	(ISA) 0x00000086 (134)	Microsoft ACPI-Compliant System















































	(ISA) 0x00000087 (135)	Microsoft ACPI-Compliant System
	(ISA) 0x00000088 (136)	Microsoft ACPI-Compliant System
	(ISA) 0x00000089 (137)	Microsoft ACPI-Compliant System
	(ISA) 0x0000008A (138)	Microsoft ACPI-Compliant System
	(ISA) 0x0000008B (139)	Microsoft ACPI-Compliant System
	(ISA) 0x0000008C (140)	Microsoft ACPI-Compliant System
	(ISA) 0x0000008D (141)	Microsoft ACPI-Compliant System
	(ISA) 0x0000008E (142)	Microsoft ACPI-Compliant System
	(ISA) 0x0000008F (143)	Microsoft ACPI-Compliant System
	(ISA) 0x00000090 (144)	Microsoft ACPI-Compliant System
	(ISA) 0x00000091 (145)	Microsoft ACPI-Compliant System
	(ISA) 0x00000092 (146)	Microsoft ACPI-Compliant System
	(ISA) 0x00000093 (147)	Microsoft ACPI-Compliant System
	(ISA) 0x00000094 (148)	Microsoft ACPI-Compliant System
	(ISA) 0x00000095 (149)	Microsoft ACPI-Compliant System
	(ISA) 0x00000096 (150)	Microsoft ACPI-Compliant System
	(ISA) 0x00000097 (151)	Microsoft ACPI-Compliant System
	(ISA) 0x00000098 (152)	Microsoft ACPI-Compliant System
	(ISA) 0x00000099 (153)	Microsoft ACPI-Compliant System
	(ISA) 0x0000009A (154)	Microsoft ACPI-Compliant System
	(ISA) 0x0000009B (155)	Microsoft ACPI-Compliant System
	(ISA) 0x0000009C (156)	Microsoft ACPI-Compliant System
	(ISA) 0x0000009D (157)	Microsoft ACPI-Compliant System
	(ISA) 0x0000009E (158)	Microsoft ACPI-Compliant System
	(ISA) 0x0000009F (159)	Microsoft ACPI-Compliant System
	(ISA) 0x000000A0 (160)	Microsoft ACPI-Compliant System
	(ISA) 0x000000A1 (161)	Microsoft ACPI-Compliant System
	(ISA) 0x000000A2 (162)	Microsoft ACPI-Compliant System
	(ISA) 0x000000A3 (163)	Microsoft ACPI-Compliant System
	(ISA) 0x000000A4 (164)	Microsoft ACPI-Compliant System
	(ISA) 0x000000A5 (165)	Microsoft ACPI-Compliant System
	(ISA) 0x000000A6 (166)	Microsoft ACPI-Compliant System
	(ISA) 0x000000A7 (167)	Microsoft ACPI-Compliant System
	(ISA) 0x000000A8 (168)	Microsoft ACPI-Compliant System
	(ISA) 0x000000A9 (169)	Microsoft ACPI-Compliant System
	(ISA) 0x000000AA (170)	Microsoft ACPI-Compliant System
	(ISA) 0x000000AB (171)	Microsoft ACPI-Compliant System
	(ISA) 0x000000AC (172)	Microsoft ACPI-Compliant System
	(ISA) 0x000000AD (173)	Microsoft ACPI-Compliant System
	(ISA) 0x000000AE (174)	Microsoft ACPI-Compliant System
	(ISA) 0x000000AF (175)	Microsoft ACPI-Compliant System
	(ISA) 0x000000B0 (176)	Microsoft ACPI-Compliant System
	(ISA) 0x000000B1 (177)	Microsoft ACPI-Compliant System
	(ISA) 0x000000B2 (178)	Microsoft ACPI-Compliant System
	(ISA) 0x000000B3 (179)	Microsoft ACPI-Compliant System
	(ISA) 0x000000B4 (180)	Microsoft ACPI-Compliant System
	(ISA) 0x000000B5 (181)	Microsoft ACPI-Compliant System















































	(ISA) 0x000000B6 (182)	Microsoft ACPI-Compliant System
	(ISA) 0x000000B7 (183)	Microsoft ACPI-Compliant System
	(ISA) 0x000000B8 (184)	Microsoft ACPI-Compliant System
	(ISA) 0x000000B9 (185)	Microsoft ACPI-Compliant System
	(ISA) 0x000000BA (186)	Microsoft ACPI-Compliant System
	(ISA) 0x000000BB (187)	Microsoft ACPI-Compliant System
	(ISA) 0x000000BC (188)	Microsoft ACPI-Compliant System
	(ISA) 0x000000BD (189)	Microsoft ACPI-Compliant System
	(ISA) 0x000000BE (190)	Microsoft ACPI-Compliant System
	(ISA) 0x000000BF (191)	Microsoft ACPI-Compliant System
	(ISA) 0x000000C0 (192)	Microsoft ACPI-Compliant System
	(ISA) 0x000000C1 (193)	Microsoft ACPI-Compliant System
	(ISA) 0x000000C2 (194)	Microsoft ACPI-Compliant System
	(ISA) 0x000000C3 (195)	Microsoft ACPI-Compliant System
	(ISA) 0x000000C4 (196)	Microsoft ACPI-Compliant System
	(ISA) 0x000000C5 (197)	Microsoft ACPI-Compliant System
	(ISA) 0x000000C6 (198)	Microsoft ACPI-Compliant System
	(ISA) 0x000000C7 (199)	Microsoft ACPI-Compliant System
	(ISA) 0x000000C8 (200)	Microsoft ACPI-Compliant System
	(ISA) 0x000000C9 (201)	Microsoft ACPI-Compliant System
	(ISA) 0x000000CA (202)	Microsoft ACPI-Compliant System
	(ISA) 0x000000CB (203)	Microsoft ACPI-Compliant System
	(ISA) 0x000000CC (204)	Microsoft ACPI-Compliant System
	(ISA) 0x00000100 (256)	Microsoft ACPI-Compliant System
	(ISA) 0x00000101 (257)	Microsoft ACPI-Compliant System
	(ISA) 0x00000102 (258)	Microsoft ACPI-Compliant System
	(ISA) 0x00000103 (259)	Microsoft ACPI-Compliant System
	(ISA) 0x00000104 (260)	Microsoft ACPI-Compliant System
	(ISA) 0x00000105 (261)	Microsoft ACPI-Compliant System
	(ISA) 0x00000106 (262)	Microsoft ACPI-Compliant System
	(ISA) 0x00000107 (263)	Microsoft ACPI-Compliant System
	(ISA) 0x00000108 (264)	Microsoft ACPI-Compliant System
	(ISA) 0x00000109 (265)	Microsoft ACPI-Compliant System
	(ISA) 0x0000010A (266)	Microsoft ACPI-Compliant System
	(ISA) 0x0000010B (267)	Microsoft ACPI-Compliant System
	(ISA) 0x0000010C (268)	Microsoft ACPI-Compliant System
	(ISA) 0x0000010D (269)	Microsoft ACPI-Compliant System
	(ISA) 0x0000010E (270)	Microsoft ACPI-Compliant System
	(ISA) 0x0000010F (271)	Microsoft ACPI-Compliant System
	(ISA) 0x00000110 (272)	Microsoft ACPI-Compliant System
	(ISA) 0x00000111 (273)	Microsoft ACPI-Compliant System
	(ISA) 0x00000112 (274)	Microsoft ACPI-Compliant System
	(ISA) 0x00000113 (275)	Microsoft ACPI-Compliant System
	(ISA) 0x00000114 (276)	Microsoft ACPI-Compliant System
	(ISA) 0x00000115 (277)	Microsoft ACPI-Compliant System
	(ISA) 0x00000116 (278)	Microsoft ACPI-Compliant System
	(ISA) 0x00000117 (279)	Microsoft ACPI-Compliant System















































 (ISA) 0x00000118 (280)	Microsoft ACPI-Compliant System
 (ISA) 0x00000119 (281)	Microsoft ACPI-Compliant System
 (ISA) 0x0000011A (282)	Microsoft ACPI-Compliant System
 (ISA) 0x0000011B (283)	Microsoft ACPI-Compliant System
 (ISA) 0x0000011C (284)	Microsoft ACPI-Compliant System
 (ISA) 0x0000011D (285)	Microsoft ACPI-Compliant System
 (ISA) 0x0000011E (286)	Microsoft ACPI-Compliant System
 (ISA) 0x0000011F (287)	Microsoft ACPI-Compliant System
 (ISA) 0x00000120 (288)	Microsoft ACPI-Compliant System
 (ISA) 0x00000121 (289)	Microsoft ACPI-Compliant System
 (ISA) 0x00000122 (290)	Microsoft ACPI-Compliant System
 (ISA) 0x00000123 (291)	Microsoft ACPI-Compliant System
 (ISA) 0x00000124 (292)	Microsoft ACPI-Compliant System
 (ISA) 0x00000125 (293)	Microsoft ACPI-Compliant System
 (ISA) 0x00000126 (294)	Microsoft ACPI-Compliant System
 (ISA) 0x00000127 (295)	Microsoft ACPI-Compliant System
 (ISA) 0x00000128 (296)	Microsoft ACPI-Compliant System
 (ISA) 0x00000129 (297)	Microsoft ACPI-Compliant System
 (ISA) 0x0000012A (298)	Microsoft ACPI-Compliant System
 (ISA) 0x0000012B (299)	Microsoft ACPI-Compliant System
 (ISA) 0x0000012C (300)	Microsoft ACPI-Compliant System
 (ISA) 0x0000012D (301)	Microsoft ACPI-Compliant System
 (ISA) 0x0000012E (302)	Microsoft ACPI-Compliant System
 (ISA) 0x0000012F (303)	Microsoft ACPI-Compliant System
 (ISA) 0x00000130 (304)	Microsoft ACPI-Compliant System
 (ISA) 0x00000131 (305)	Microsoft ACPI-Compliant System
 (ISA) 0x00000132 (306)	Microsoft ACPI-Compliant System
 (ISA) 0x00000133 (307)	Microsoft ACPI-Compliant System
 (ISA) 0x00000134 (308)	Microsoft ACPI-Compliant System
 (ISA) 0x00000135 (309)	Microsoft ACPI-Compliant System
 (ISA) 0x00000136 (310)	Microsoft ACPI-Compliant System
 (ISA) 0x00000137 (311)	Microsoft ACPI-Compliant System
 (ISA) 0x00000138 (312)	Microsoft ACPI-Compliant System
 (ISA) 0x00000139 (313)	Microsoft ACPI-Compliant System
 (ISA) 0x0000013A (314)	Microsoft ACPI-Compliant System
 (ISA) 0x0000013B (315)	Microsoft ACPI-Compliant System
 (ISA) 0x0000013C (316)	Microsoft ACPI-Compliant System
 (ISA) 0x0000013D (317)	Microsoft ACPI-Compliant System
 (ISA) 0x0000013E (318)	Microsoft ACPI-Compliant System
 (ISA) 0x0000013F (319)	Microsoft ACPI-Compliant System
 (ISA) 0x00000140 (320)	Microsoft ACPI-Compliant System
 (ISA) 0x00000141 (321)	Microsoft ACPI-Compliant System
 (ISA) 0x00000142 (322)	Microsoft ACPI-Compliant System
 (ISA) 0x00000143 (323)	Microsoft ACPI-Compliant System
 (ISA) 0x00000144 (324)	Microsoft ACPI-Compliant System
 (ISA) 0x00000145 (325)	Microsoft ACPI-Compliant System
 (ISA) 0x00000146 (326)	Microsoft ACPI-Compliant System















































 (ISA) 0x00000176 (374)	Microsoft ACPI-Compliant System
 (ISA) 0x00000177 (375)	Microsoft ACPI-Compliant System
 (ISA) 0x00000178 (376)	Microsoft ACPI-Compliant System
 (ISA) 0x00000179 (377)	Microsoft ACPI-Compliant System
 (ISA) 0x0000017A (378)	Microsoft ACPI-Compliant System
 (ISA) 0x0000017B (379)	Microsoft ACPI-Compliant System
 (ISA) 0x0000017C (380)	Microsoft ACPI-Compliant System
 (ISA) 0x0000017D (381)	Microsoft ACPI-Compliant System
 (ISA) 0x0000017E (382)	Microsoft ACPI-Compliant System
 (ISA) 0x0000017F (383)	Microsoft ACPI-Compliant System
 (ISA) 0x00000180 (384)	Microsoft ACPI-Compliant System
 (ISA) 0x00000181 (385)	Microsoft ACPI-Compliant System
 (ISA) 0x00000182 (386)	Microsoft ACPI-Compliant System
 (ISA) 0x00000183 (387)	Microsoft ACPI-Compliant System
 (ISA) 0x00000184 (388)	Microsoft ACPI-Compliant System
 (ISA) 0x00000185 (389)	Microsoft ACPI-Compliant System
 (ISA) 0x00000186 (390)	Microsoft ACPI-Compliant System
 (ISA) 0x00000187 (391)	Microsoft ACPI-Compliant System
 (ISA) 0x00000188 (392)	Microsoft ACPI-Compliant System
 (ISA) 0x00000189 (393)	Microsoft ACPI-Compliant System
 (ISA) 0x0000018A (394)	Microsoft ACPI-Compliant System
 (ISA) 0x0000018B (395)	Microsoft ACPI-Compliant System
 (ISA) 0x0000018C (396)	Microsoft ACPI-Compliant System
 (ISA) 0x0000018D (397)	Microsoft ACPI-Compliant System
 (ISA) 0x0000018E (398)	Microsoft ACPI-Compliant System
 (ISA) 0x0000018F (399)	Microsoft ACPI-Compliant System
 (ISA) 0x00000190 (400)	Microsoft ACPI-Compliant System
 (ISA) 0x00000191 (401)	Microsoft ACPI-Compliant System
 (ISA) 0x00000192 (402)	Microsoft ACPI-Compliant System
 (ISA) 0x00000193 (403)	Microsoft ACPI-Compliant System
 (ISA) 0x00000194 (404)	Microsoft ACPI-Compliant System
 (ISA) 0x00000195 (405)	Microsoft ACPI-Compliant System
 (ISA) 0x00000196 (406)	Microsoft ACPI-Compliant System
 (ISA) 0x00000197 (407)	Microsoft ACPI-Compliant System
 (ISA) 0x00000198 (408)	Microsoft ACPI-Compliant System
 (ISA) 0x00000199 (409)	Microsoft ACPI-Compliant System
 (ISA) 0x0000019A (410)	Microsoft ACPI-Compliant System
 (ISA) 0x0000019B (411)	Microsoft ACPI-Compliant System
 (ISA) 0x0000019C (412)	Microsoft ACPI-Compliant System
 (ISA) 0x0000019D (413)	Microsoft ACPI-Compliant System
 (ISA) 0x0000019E (414)	Microsoft ACPI-Compliant System
 (ISA) 0x0000019F (415)	Microsoft ACPI-Compliant System
 (ISA) 0x000001A0 (416)	Microsoft ACPI-Compliant System
 (ISA) 0x000001A1 (417)	Microsoft ACPI-Compliant System
 (ISA) 0x000001A2 (418)	Microsoft ACPI-Compliant System
 (ISA) 0x000001A3 (419)	Microsoft ACPI-Compliant System
 (ISA) 0x000001A4 (420)	Microsoft ACPI-Compliant System

	(ISA) 0x000001A5 (421)	Microsoft ACPI-Compliant System
	(ISA) 0x000001A6 (422)	Microsoft ACPI-Compliant System
	(ISA) 0x000001A7 (423)	Microsoft ACPI-Compliant System
	(ISA) 0x000001A8 (424)	Microsoft ACPI-Compliant System
	(ISA) 0x000001A9 (425)	Microsoft ACPI-Compliant System
	(ISA) 0x000001AA (426)	Microsoft ACPI-Compliant System
	(ISA) 0x000001AB (427)	Microsoft ACPI-Compliant System
	(ISA) 0x000001AC (428)	Microsoft ACPI-Compliant System
	(ISA) 0x000001AD (429)	Microsoft ACPI-Compliant System
	(ISA) 0x000001AE (430)	Microsoft ACPI-Compliant System
	(ISA) 0x000001AF (431)	Microsoft ACPI-Compliant System
	(ISA) 0x000001B0 (432)	Microsoft ACPI-Compliant System
	(ISA) 0x000001B1 (433)	Microsoft ACPI-Compliant System
	(ISA) 0x000001B2 (434)	Microsoft ACPI-Compliant System
	(ISA) 0x000001B3 (435)	Microsoft ACPI-Compliant System
	(ISA) 0x000001B4 (436)	Microsoft ACPI-Compliant System
	(ISA) 0x000001B5 (437)	Microsoft ACPI-Compliant System
	(ISA) 0x000001B6 (438)	Microsoft ACPI-Compliant System
	(ISA) 0x000001B7 (439)	Microsoft ACPI-Compliant System
	(ISA) 0x000001B8 (440)	Microsoft ACPI-Compliant System
	(ISA) 0x000001B9 (441)	Microsoft ACPI-Compliant System
	(ISA) 0x000001BA (442)	Microsoft ACPI-Compliant System
	(ISA) 0x000001BB (443)	Microsoft ACPI-Compliant System
	(ISA) 0x000001BC (444)	Microsoft ACPI-Compliant System
	(ISA) 0x000001BD (445)	Microsoft ACPI-Compliant System
	(ISA) 0x000001BE (446)	Microsoft ACPI-Compliant System
	(ISA) 0x000001BF (447)	Microsoft ACPI-Compliant System
	(ISA) 0x000001C0 (448)	Microsoft ACPI-Compliant System
	(ISA) 0x000001C1 (449)	Microsoft ACPI-Compliant System
	(ISA) 0x000001C2 (450)	Microsoft ACPI-Compliant System
	(ISA) 0x000001C3 (451)	Microsoft ACPI-Compliant System
	(ISA) 0x000001C4 (452)	Microsoft ACPI-Compliant System
	(ISA) 0x000001C5 (453)	Microsoft ACPI-Compliant System
	(ISA) 0x000001C6 (454)	Microsoft ACPI-Compliant System
	(ISA) 0x000001C7 (455)	Microsoft ACPI-Compliant System
	(ISA) 0x000001C8 (456)	Microsoft ACPI-Compliant System
	(ISA) 0x000001C9 (457)	Microsoft ACPI-Compliant System
	(ISA) 0x000001CA (458)	Microsoft ACPI-Compliant System
	(ISA) 0x000001CB (459)	Microsoft ACPI-Compliant System
	(ISA) 0x000001CC (460)	Microsoft ACPI-Compliant System
	(ISA) 0x000001CD (461)	Microsoft ACPI-Compliant System
	(ISA) 0x000001CE (462)	Microsoft ACPI-Compliant System
	(ISA) 0x000001CF (463)	Microsoft ACPI-Compliant System
	(ISA) 0x000001D0 (464)	Microsoft ACPI-Compliant System
	(ISA) 0x000001D1 (465)	Microsoft ACPI-Compliant System
	(ISA) 0x000001D2 (466)	Microsoft ACPI-Compliant System
	(ISA) 0x000001D3 (467)	Microsoft ACPI-Compliant System

 (ISA) 0x000001D4 (468)	Microsoft ACPI-Compliant System
 (ISA) 0x000001D5 (469)	Microsoft ACPI-Compliant System
 (ISA) 0x000001D6 (470)	Microsoft ACPI-Compliant System
 (ISA) 0x000001D7 (471)	Microsoft ACPI-Compliant System
 (ISA) 0x000001D8 (472)	Microsoft ACPI-Compliant System
 (ISA) 0x000001D9 (473)	Microsoft ACPI-Compliant System
 (ISA) 0x000001DA (474)	Microsoft ACPI-Compliant System
 (ISA) 0x000001DB (475)	Microsoft ACPI-Compliant System
 (ISA) 0x000001DC (476)	Microsoft ACPI-Compliant System
 (ISA) 0x000001DD (477)	Microsoft ACPI-Compliant System
 (ISA) 0x000001DE (478)	Microsoft ACPI-Compliant System
 (ISA) 0x000001DF (479)	Microsoft ACPI-Compliant System
 (ISA) 0x000001E0 (480)	Microsoft ACPI-Compliant System
 (ISA) 0x000001E1 (481)	Microsoft ACPI-Compliant System
 (ISA) 0x000001E2 (482)	Microsoft ACPI-Compliant System
 (ISA) 0x000001E3 (483)	Microsoft ACPI-Compliant System
 (ISA) 0x000001E4 (484)	Microsoft ACPI-Compliant System
 (ISA) 0x000001E5 (485)	Microsoft ACPI-Compliant System
 (ISA) 0x000001E6 (486)	Microsoft ACPI-Compliant System
 (ISA) 0x000001E7 (487)	Microsoft ACPI-Compliant System
 (ISA) 0x000001E8 (488)	Microsoft ACPI-Compliant System
 (ISA) 0x000001E9 (489)	Microsoft ACPI-Compliant System
 (ISA) 0x000001EA (490)	Microsoft ACPI-Compliant System
 (ISA) 0x000001EB (491)	Microsoft ACPI-Compliant System
 (ISA) 0x000001EC (492)	Microsoft ACPI-Compliant System
 (ISA) 0x000001ED (493)	Microsoft ACPI-Compliant System
 (ISA) 0x000001EE (494)	Microsoft ACPI-Compliant System
 (ISA) 0x000001EF (495)	Microsoft ACPI-Compliant System
 (ISA) 0x000001F0 (496)	Microsoft ACPI-Compliant System
 (ISA) 0x000001F1 (497)	Microsoft ACPI-Compliant System
 (ISA) 0x000001F2 (498)	Microsoft ACPI-Compliant System
 (ISA) 0x000001F3 (499)	Microsoft ACPI-Compliant System
 (ISA) 0x000001F4 (500)	Microsoft ACPI-Compliant System
 (ISA) 0x000001F5 (501)	Microsoft ACPI-Compliant System
 (ISA) 0x000001F6 (502)	Microsoft ACPI-Compliant System
 (ISA) 0x000001F7 (503)	Microsoft ACPI-Compliant System
 (ISA) 0x000001F8 (504)	Microsoft ACPI-Compliant System
 (ISA) 0x000001F9 (505)	Microsoft ACPI-Compliant System
 (ISA) 0x000001FA (506)	Microsoft ACPI-Compliant System
 (ISA) 0x000001FB (507)	Microsoft ACPI-Compliant System
 (ISA) 0x000001FC (508)	Microsoft ACPI-Compliant System
 (ISA) 0x000001FD (509)	Microsoft ACPI-Compliant System
 (ISA) 0x000001FE (510)	Microsoft ACPI-Compliant System
 (ISA) 0x000001FF (511)	Microsoft ACPI-Compliant System
 (PCI) 0x00000005 (05)	Intel(R) 8 Series/C220 Series SMBus Controller - 8C22
 (PCI) 0x00000010 (16)	Intel(R) 8 Series/C220 Series USB EHCI #2 - 8C2D
 (PCI) 0x00000013 (19)	Intel(R) Active Management Technology - SOL (COM7)







	(ISA) 0x000001E3 (483)	Microsoft ACPI-Compliant System
	(ISA) 0x000001E4 (484)	Microsoft ACPI-Compliant System
	(ISA) 0x000001E5 (485)	Microsoft ACPI-Compliant System
	(ISA) 0x000001E6 (486)	Microsoft ACPI-Compliant System
	(ISA) 0x000001E7 (487)	Microsoft ACPI-Compliant System
	(ISA) 0x000001E8 (488)	Microsoft ACPI-Compliant System
	(ISA) 0x000001E9 (489)	Microsoft ACPI-Compliant System
	(ISA) 0x000001EA (490)	Microsoft ACPI-Compliant System
	(ISA) 0x000001EB (491)	Microsoft ACPI-Compliant System
	(ISA) 0x000001EC (492)	Microsoft ACPI-Compliant System
	(ISA) 0x000001ED (493)	Microsoft ACPI-Compliant System
	(ISA) 0x000001EE (494)	Microsoft ACPI-Compliant System
	(ISA) 0x000001EF (495)	Microsoft ACPI-Compliant System
	(ISA) 0x000001F0 (496)	Microsoft ACPI-Compliant System
	(ISA) 0x000001F1 (497)	Microsoft ACPI-Compliant System
	(ISA) 0x000001F2 (498)	Microsoft ACPI-Compliant System
	(ISA) 0x000001F3 (499)	Microsoft ACPI-Compliant System
	(ISA) 0x000001F4 (500)	Microsoft ACPI-Compliant System
	(ISA) 0x000001F5 (501)	Microsoft ACPI-Compliant System
	(ISA) 0x000001F6 (502)	Microsoft ACPI-Compliant System
	(ISA) 0x000001F7 (503)	Microsoft ACPI-Compliant System
	(ISA) 0x000001F8 (504)	Microsoft ACPI-Compliant System
	(ISA) 0x000001F9 (505)	Microsoft ACPI-Compliant System
	(ISA) 0x000001FA (506)	Microsoft ACPI-Compliant System
	(ISA) 0x000001FB (507)	Microsoft ACPI-Compliant System
	(ISA) 0x000001FC (508)	Microsoft ACPI-Compliant System
	(ISA) 0x000001FD (509)	Microsoft ACPI-Compliant System
	(ISA) 0x000001FE (510)	Microsoft ACPI-Compliant System
	(ISA) 0x000001FF (511)	Microsoft ACPI-Compliant System
	(PCI) 0x00000005 (05)	Intel(R) 8 Series/C220 Series SMBus Controller - 8C22
	(PCI) 0x00000010 (16)	Intel(R) 8 Series/C220 Series USB EHCI #2 - 8C2D
	(PCI) 0x00000013 (19)	Intel(R) Active Management Technology - SOL (COM7)
	(PCI) 0x00000013 (19)	Standard Dual Channel PCI IDE Controller
	(PCI) 0x00000016 (22)	High Definition Audio Controller
	(PCI) 0x00000017 (23)	Intel(R) 8 Series/C220 Series USB EHCI #1 - 8C26
	(PCI) 0xFFFFFFFF4 (-12)	Intel(R) I211 Gigabit Network Connection
	(PCI) 0xFFFFFFFF5 (-11)	Intel(R) I211 Gigabit Network Connection
	(PCI) 0xFFFFFFFF6 (-10)	Intel(R) I211 Gigabit Network Connection
	(PCI) 0xFFFFFFFF7 (-9)	Intel(R) I211 Gigabit Network Connection
	(PCI) 0xFFFFFFFF8 (-8)	Intel(R) Ethernet Connection I217-LM
	(PCI) 0xFFFFFFFF9 (-7)	Intel(R) Management Engine Interface
	(PCI) 0xFFFFFFFFA (-6)	Intel(R) USB 3.0 eXtensible Host Controller - 1.0 (Microsoft)
	(PCI) 0xFFFFFFFFB (-5)	Intel(R) HD Graphics 4600
	(PCI) 0xFFFFFFFFC (-4)	Intel(R) 8 Series/C220 Series PCI Express Root Port #8 - 8C1E
	(PCI) 0xFFFFFFFFD (-3)	Intel(R) 8 Series/C220 Series PCI Express Root Port #1 - 8C10
	(PCI) 0xFFFFFFFFE (-2)	Intel(R) Xeon(R) processor E3 - 1200 v3/4th Gen Core processor PCI Express x16 Controller - 0C01

>  Memory

- ▼  DESKTOP-FEQ8M05
  - >  Direct memory access (DMA)
  - >  Input/output (IO)
  - >  Interrupt request (IRQ)
  - ▼  Memory
    -  [0000000000A0000 - 0000000000BFFFF] Intel(R) HD Graphics 4600
    -  [0000000000A0000 - 0000000000BFFFF] PCI Express Root Complex
    -  [0000000000D0000 - 0000000000D3FFF] PCI Express Root Complex
    -  [0000000000D4000 - 0000000000D7FFF] PCI Express Root Complex
    -  [0000000000D8000 - 0000000000DBFFF] PCI Express Root Complex
    -  [0000000000DC000 - 0000000000DFFFF] PCI Express Root Complex
    -  [0000000000E0000 - 0000000000E3FFF] PCI Express Root Complex
    -  [0000000000E4000 - 0000000000E7FFF] PCI Express Root Complex
    -  [0000000000F200000 - 0000000000F7FFF] PCI Express Root Complex
    -  [00000000E0000000 - 00000000FFFFFFF] Intel(R) HD Graphics 4600
    -  [00000000F7800000 - 00000000FBFFFFF] Intel(R) HD Graphics 4600
    -  [00000000F7C00000 - 00000000F7C1FFFF] Intel(R) I211 Gigabit Network Connection
    -  [00000000F7C00000 - 00000000F7CFFFFF] Intel(R) 8 Series/C220 Series PCI Express Root Port #8 - 8C1E
    -  [00000000F7C20000 - 00000000F7C23FFF] Intel(R) I211 Gigabit Network Connection
    -  [00000000F7D00000 - 00000000F7D1FFFF] Intel(R) Ethernet Connection I217-LM
    -  [00000000F7D20000 - 00000000F7D2FFFF] Intel(R) USB 3.0 eXtensible Host Controller - 1.0 (Microsoft)
    -  [00000000F7D30000 - 00000000F7D33FFF] High Definition Audio Controller
    -  [00000000F7D34000 - 00000000F7D37FFF] High Definition Audio Controller
    -  [00000000F7D39000 - 00000000F7D390FF] Intel(R) 8 Series/C220 Series SMBus Controller - 8C22
    -  [00000000F7D3A000 - 00000000F7D3A3FF] Intel(R) 8 Series/C220 Series USB EHCI #1 - 8C26
    -  [00000000F7D3B000 - 00000000F7D3B3FF] Intel(R) 8 Series/C220 Series USB EHCI #2 - 8C2D
    -  [00000000F7D3C000 - 00000000F7D3CFFF] Intel(R) Ethernet Connection I217-LM
    -  [00000000F7D3D000 - 00000000F7D3DFFF] Intel(R) Active Management Technology - SOL (COM7)
    -  [00000000F7D3F000 - 00000000F7D3F0FF] Intel(R) Management Engine Interface
    -  [00000000F7FDF000 - 00000000F7FDFFFF] Motherboard resources
    -  [00000000F7FE0000 - 00000000F7FEFFFF] Motherboard resources
    -  [00000000F8000000 - 00000000FBFFFFF] Motherboard resources
    -  [00000000FED00000 - 00000000FED003FF] High precision event timer
    -  [00000000FED10000 - 00000000FED17FFF] Motherboard resources
    -  [00000000FED18000 - 00000000FED18FFF] Motherboard resources
    -  [00000000FED19000 - 00000000FED19FFF] Motherboard resources
    -  [00000000FED1C000 - 00000000FED1FFFF] Motherboard resources
    -  [00000000FED20000 - 00000000FED33FFF] Motherboard resources
    -  [00000000FED40000 - 00000000FED44FFF] System board
    -  [00000000FED45000 - 00000000FED8FFFF] Motherboard resources
    -  [00000000FED90000 - 00000000FED93FFF] Motherboard resources
    -  [00000000FEE00000 - 00000000FEEFFFFF] Motherboard resources
    -  [00000000FF000000 - 00000000FFFFFFFFF] Legacy device
    -  [00000000FF000000 - 00000000FFFFFFFFF] Motherboard resources

## B.4 DMA Channel Assignments

---

- ▼  **DESKTOP-FEQ8M05**
  - ▼  Direct memory access (DMA)
    -  4 Direct memory access controller
  - >  Input/output (IO)
  - >  Interrupt request (IRQ)
  - >  Memory