

# DT122-GH

Ryzen



FC CE

### ► Features

- AMD Ryzen V1000/R1000 Desktop Box PC
- 2 DDR4 SODIMM up to 64GB
- 4 DP++ resolution up to 4096x2160 @ 60Hz
- 1x 3.5" or 2x 2.5" SATA drive bay
- Supports 1 expansion slot: 1 PCIe or 1 PCI
- Built in 150W psu



### ► Panel

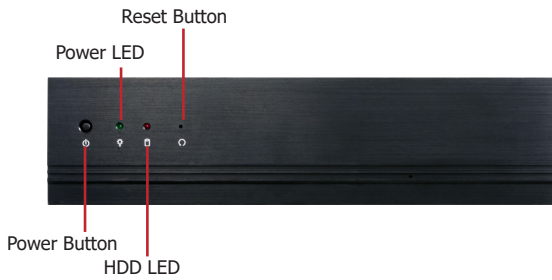

Front View

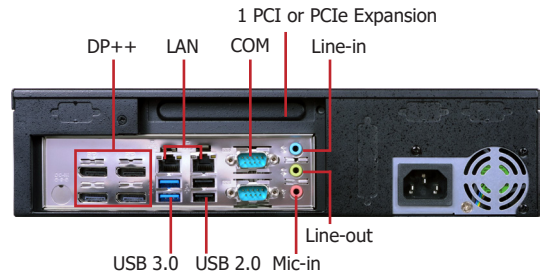

Rear View

### ► Dimensions

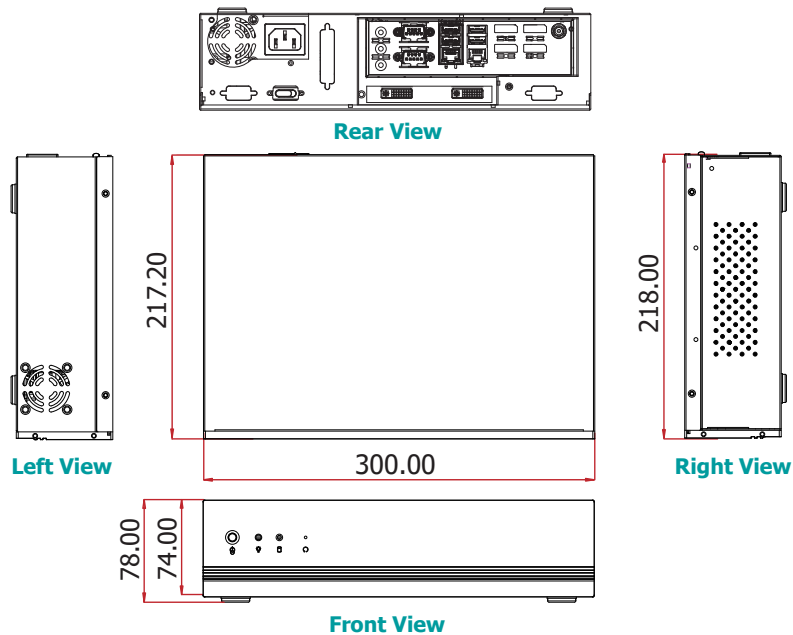

## ► Specifications

<b>SYSTEM</b>	<b>Processor</b>	AMD® Ryzen™ Embedded V1000 series AMD® Ryzen™ Embedded V1807, Quad Core, 2M Cache, 11 CU, 3.35GHz (3.8GHz), 35-54W AMD® Ryzen™ Embedded V1756, Quad Core, 2M Cache, 8 CU, 3.25GHz (3.6GHz), 35-54W AMD® Ryzen™ Embedded V1605, Quad Core, 2M Cache, 8 CU, 2.0GHz (3.6GHz), 12-25W AMD® Ryzen™ Embedded V1202, Dual Core, 1M Cache, 3 CU, 2.3GHz (3.2GHz), 12-25W AMD® Ryzen™ Embedded R1000 series
	<b>Memory</b>	Two 260-pin SODIMM up to 32GB Dual Channel DDR4 3200MHz
	<b>BIOS</b>	AMI BIOS
	<b>GRAPHICS</b>	<b>Controller</b>
<b>GRAPHICS</b>	<b>Feature</b>	OpenGL 4.5, DirectX 12, OpenCL 2.1 HW Decode: AVC/H.264, MPEG2, VC1/WMV9, JPEG/MJPEG, HEVC/H265, VP8, VP9 HW Encode: MPEG2, AVC/H264, JPEG, HEVC/H265, VP8, VP9
	<b>Display</b>	4 x DP++ (V1000) DP: resolution up to 4096x2160 @ 60Hz 3 x DP++ (R1000)
	<b>Four Displays</b>	DP++ (R1000 supports triple displays)
	<b>STORAGE</b>	1 x 3.5" or 2 x 2.5" SATA 3.0 Drive Bay 1 x M.2 2280 NVME SSD (2280 PCIe x4), (x2 signal with R1000)
<b>EXPANSION</b>	<b>Interface</b>	1 x PCIe or 1 x PCI (through optional riser card)
<b>AUDIO</b>	<b>Audio Codec</b>	Realtek Audio Codec with 5.1 Channel Support
<b>ETHERNET</b>	<b>Controller</b>	2 x Realtek Ethernet LAN Controller
<b>LED</b>	<b>Indicators</b>	1 x Power LED 1 x HDD LED
<b>FRONT I/O</b>	<b>Buttons</b>	1 x Power Button
<b>REAR I/O</b>	<b>Ethernet</b>	2 x GbE (RJ-45)
	<b>Serial</b>	1 x RS-232/422/485 (DB-9) 1 x RS-232 (DB-9)
	<b>USB</b>	2 x USB 3.0 2 x USB 2.0
	<b>Display</b>	4 x DP++ (V1000), or 3 x DP++ (R1000)
	<b>Audio</b>	1 x Line-in 1 x Line-out 1 x Mic-in
<b>COOLING</b>	<b>Fan</b>	1 x System Fan 1 x CPU Fan
<b>WATCHDOG TIMER</b>	<b>Output &amp; Interval</b>	System Reset, Programmable via Software from 1 to 255 Seconds
<b>POWER</b>	<b>Supply</b>	AC150W, ATX, 100 to 240V AC input
<b>OS SUPPORT</b>		Windows 10 Linux
<b>MECHANISM</b>	<b>Construction</b>	Front Bezel aluminum + Chassis Sheet Metal
	<b>Mounting</b>	Wall mount
	<b>Dimensions ( W x H x D )</b>	300mm x 75mm x 217mm
	<b>Weight</b>	3.7 Kg
<b>ENVIRONMENT</b>	<b>Operating Temperature</b>	0 to 45°C
	<b>Storage Temperature</b>	-40 to 85°C
	<b>Relative Humidity</b>	10 to 90% RH (non-condensing)
<b>STANDARDS AND CERTIFICATIONS</b>	<b>Certification</b>	CE, FCC Class A



Wall Mounting

Type A Wall mount bracket

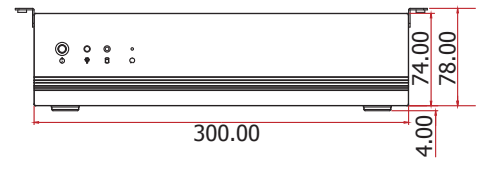
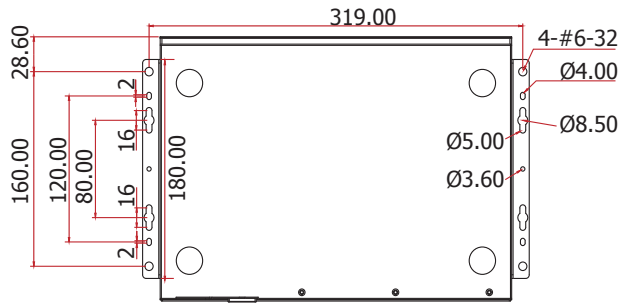
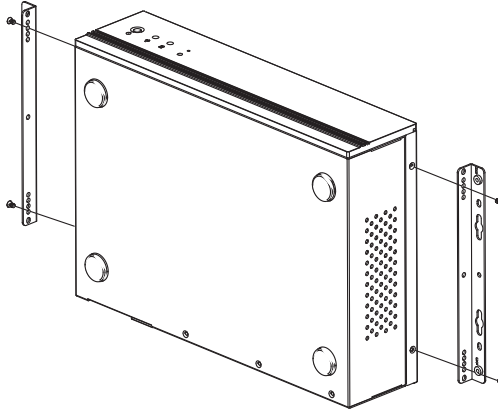

Type B Wall mount bracket

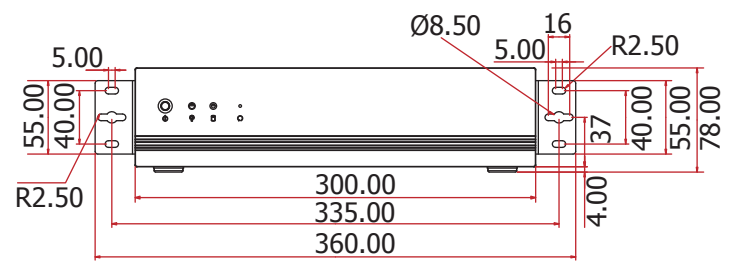
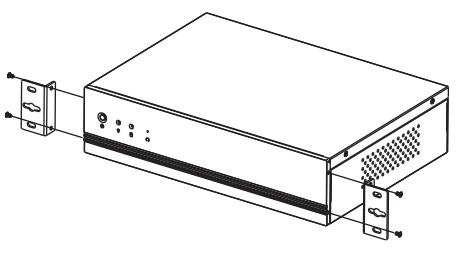

► **Ordering Information**

Model Name	Part Number	Description
<b>DT122-GH</b>	750-DT1222-000G	DT122-GH: GH171-V1807B, 150W, F/G SYSTEM, RoHS
<b>DT122-GH</b>	750-DT1222-100G	DT122-GH: GH171-V1807B, 150W, PCIe Riser, F/G SYSTEM, RoHS
<b>DT122-GH</b>	750-DT1222-200G	DT122-GH: GH171-V1807B, 150W, PCI Riser, F/G SYSTEM, RoHS

► **Option Item**

Model Name	Part Number	Description
<b>CPU</b>	785-1151DL	CPU, LGA1151, Long-Term Support, RoHS
<b>Memory</b>	138-540002-106G	4GB DDR4 2666Mhz SO-DIMM 1Rx8 512Mx8 CL19 1.2V
	138-580004-102G	8GB DDR4 2666Mhz SO-DIMM 1Rx8 1Gx8 CL19 1.2V
	138-5G0163-102G	16GB DDR4 2666Mhz SO-DIMM 2Rx8 1Gx8 CL19 1.2V
<b>SSD 2.5"</b> <b>(for all model)</b>	635-600322-1A0G	32GB, 2.5" SSD, SATA3, MLC
	635-600644-100G	64GB, 2.5" SSD, SATA3, MLC
	635-601282-1E0G	128GB, 2.5" SSD, SATA3, MLC
	635-602562-121G	256GB, 2.5" SSD, SATA3, MLC
	635-605122-130G	512GB, 2.5" SSD, SATA3, MLC
	635-601286-110G	128GB, 2.5" SSD, SATA3, 3D TLC, PE: 3K
	TBD	256GB, 2.5" SSD, SATA3, 3D TLC, PE: 3K
	TBD	512GB, 2.5" SSD, SATA3, 3D TLC, PE: 3K
<b>SSD M.2 2280</b>	TBD	32GB, M.2 2280 SSD, SATA3 B+M Key, MLC
	TBD	64GB, M.2 2280 SSD, SATA3 B+M Key, MLC
	638-712811-100G	128GB, M.2 2280 SSD, SATA3 B+M Key, MLC
	638-725615-100G	256GB, M.2 2280 SSD, SATA3 B+M Key, MLC
	638-712818-100G	128GB, M.2 2280 SSD, SATA3 B+M Key, 3D TLC, PE: 3K
	638-725614-100G	256GB, M.2 2280 SSD, SATA3 B+M Key, 3D TLC, PE: 3K
	TBD	512GB, M.2 2280 SSD, SATA3 B+M Key, 3D TLC, PE: 3K
	638-701T01-100G	1TB, M.2 2280 SSD, SATA3 B+M Key, 3D TLC, PE: 3K
	638-712816-110G	128GB, M.2 2280, PCIe Gen3x4, M-Key, 3D TLC, PE: 3K
	638-725608-100G	256GB, M.2 2280, PCIe Gen3x4, M-Key, 3D TLC, PE: 3K
	TBD	512GB, M.2 2280, PCIe Gen3x4, M-Key, 3D TLC, PE: 3K
	TBD	1TB, M.2 2280, PCIe Gen3x4, M-Key, 3D TLC, PE: 3K
<b>HDD 2.5"</b>	635-550092-090G	2.5" SATAIII 500GB 5400RPM 128MB BLUE
	635-500100-220G	2.5" SATAIII 1TB 5400RPM 128MB BLUE
	TBD	2.5" SATAIII 2TB 5400RPM 128MB BLUE
	TBD	2.5" SATAIII 500GB 7200RPM 64MB BLACK
	635-500111-000G	2.5" SATAIII 1TB 7200RPM 64MB BLACK

► **Option Item**

<b>HDD 3.5"</b>	635-550091-040G	HDD 3.5" SATAIII 500GB 7200RPM 32MB BLUE
	635-510002-300G	HDD 3.5" SATAIII 1TB 7200RPM 64MB BLUE
	635-500208-300G	HDD 3.5" SATAIII 2TB 5400RPM 256MB BLUE
	TBD	HDD 3.5" SATAIII 3TB 5400RPM 64MB BLUE
	635-500401-300G	HDD 3.5" SATAIII 4TB 5400RPM 64MB BLUE
	TBD	HDD 3.5" SATAIII 6TB 5400RPM 256MB BLUE
	635-500801-300G	HDD 3.5" SATAIII 8TB 7200RPM 256MB, DC HC320, HUS728T8TALE6L4, WD
	SPL-63500198	HDD 3.5" SATAIII 8TB 7200RPM 256MB, Gold WD8003FRYZ, WD
	TBD	HDD 3.5" SATAIII 12TB 7200RPM 256MB, Purple WD121PURZ, WD
	TBD	HDD 3.5" SATAIII 12TB 7200RPM 256MB, HUH721212ALE604 (0F30146), WD
<b>mSATA</b>	785-MS128GMF	mSATA Card, 128GB MLC, RoHS
	785-MS64GMF	mSATA Card, 64GB MLC, RoHS
	785-MS32GMF	mSATA Card, 32GB MLC, RoHS
	785-MS16GMF	mSATA Card, 16GB MLC, RoHS
	785-MS08GMF	mSATA Card, 8GB MLC, RoHS
	785-MS04GMF	mSATA Card, 4GB MLC, RoHS
<b>WiFi/BT Kit</b>	761-OPS150-001G	1x intel M.2 2230 AC 3168.NGWG 802.11abgn/ac 1T1R + Bluetooth 4.2 2x MHF4 to SMA cable 200mm 2x dipole antenna 1x M2x4mm screw
	TBD	M.2 2280 B/M key to M.2 2230 A/E key adapter card
<b>Power Cord</b>	785-PWRD	Power Cord, Standards (USA/EUR/CH), 1.8m, RoHS
<b>Wall Mount</b>	761-DT1220-100G	DT122 Type A Wall Mount Kit for Top Cover, RoHS
	761-DT1220-000G	DT122 Type B Wall Mount Kit for Front Cover, RoHS
<b>Adapter Card</b>	TBD	M.2 2280 M key to M.2 A key, support WiFi module

► **Packing List**

• 1 DT122-GH system unit
• 1 CPU cooler
• 1 HDD drive bay kit
• 1 Heatsink/fan
• 1 Quick Installation Guide