

AFL3 Whiskey Lake with PoE

NEW

Intelligent PoE Management System

Features

- W15.6"~ W21.5" light industrial interactive panel PC
- 8th Generation Intel® Core™ i5 on-board Whiskey Lake-U processor
- Selectable AT/ATX power mode
- Built-in speakers
- Support PoE PD IEEE802.3 af/at/bt (optional)
- IP64 compliant front panel
- Touch screen with anti-UV / anti-glare coating
- Support Auto Flow Control over RS-485



Specifications

Model		AFL3-W15C-ULT5	AFL3-W19C-ULT5	AFL3-W22C-ULT5
LCD	Size	15.6"	18.5"	21.5"
	Resolution	1366 x 768 (16:9)	1366 x 768 (16:9)	1920 x 1080 (16:9)
	Brightness (cd/m ²)	300	250	250
	Contrast Ratio	500:1	1000:1	1000:1
	Viewing Angle (H-V)	170°/160°	170°/160°	170°/160°
	Backlight MTBF (hrs)	50000	30000	30000
Touch Screen		PCAP with USB interface (anti-UV/AG coating)		
Touch Controller		EXC3160		
Mainboard	CPU	Intel® Whiskey Lake-U quad-core processor		
	Memory	Two 260-pin 2400MHz dual-channel DDR4 SO-DIMMs supporting up to 32 GB		
	Ethernet	LAN1 & LAN2: Intel® I211; LAN3: Intel® I219		
	Audio Codec	Realtek ALC 888S		
Storage		1 x M.2 M-key 2280 PCIe 3.0 x4 (PCIe/SATA Signal) 1 x 2.5" SATA 3Gb/s HDD bay		
I/O Ports & Switch		2 x PoE GbE LAN (optional IEEE802.3af/at/bt) 1 x GbE LAN 4 x USB 3.2 Gen.2 1 x HDMI output 1 x RS-232/422/485 1 x RS-232 1 x 12V DC jack 1 x Power Button 1 x AT/ATX switch		
Audio		AMP 3W + 3W (internal speaker)		
Camera / Microphone		2-megapixel with low light function, digital microphone		
Wireless & Bluetooth		IEEE 802.11 a/b/g/n/ac, Bluetooth V4.1 M.2 A+E key 2230 slot (PCIe/USB signal)		
Physical	Construction Front Panel	PC + ABS Plastic		
	Mounting	Panel, Wall, Stand and Arm VESA 75mm x 75mm, 100mm x 100mm		
	Color	Black C		
	Dimensions (W x H x D) (mm)	396 x 250 x 64	470 x 290 x 70	528 x 336 x 68
	Cut-out Dimensions (W x H)	369 x 226	443 x 261	502 x 303
	Net/Gross Weight (kgs)	4.5/6.5	7.3/10	8.27/11.27
Environment	Operating Temperature (°C) (Ambient with air flow)	-20°C~50°C		
	Storage Temperature (°C)	-20°C~60°C		
	Humidity	10% to 95% (non-condensing)		
	IP Level	IP 64 compliant front panel		
	Safety & EMC	CE / FCC class A		
	Thermal Solution	Fanless		
Power	Power Requirement	12V, 8A PoE IEEE802.3 af/at/bt (redundancy, power load-sharing)		
ErP		ErP 2009/125/EC		
Supported OS		Microsoft Windows® 10 / Windows® 11, Linux		

Rich Interface

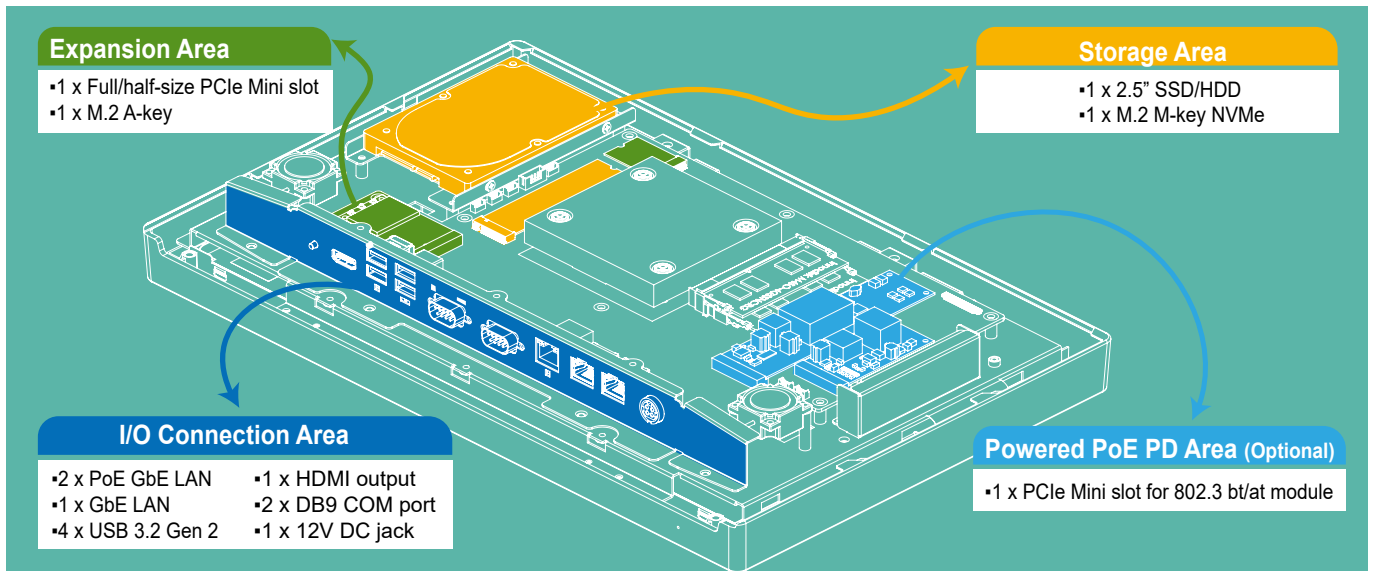

IEEE802.3 PD Module

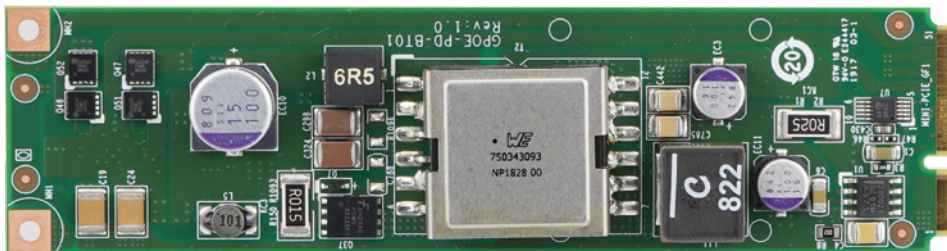

GPOE-PD-BT01-R10

- Support PoE IEEE802.3 af/at/bt
- Support up to 71watt PD
- PCIe Mini form factor (IEI defined pin)
- Operating temperature: -10°C~60°C
- Operating humidity: 5% ~ 95%

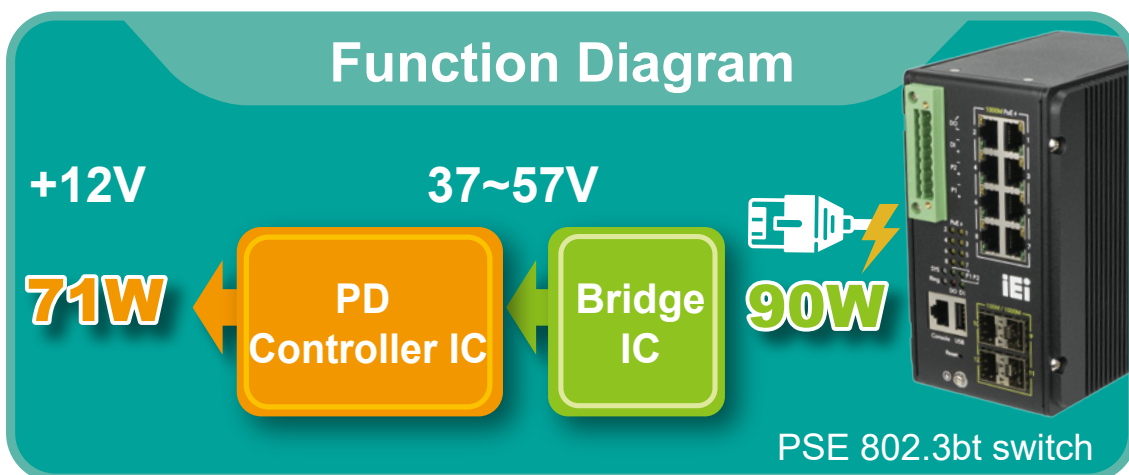

Ordering Information

Part No.	Description
AFL3-W15C-ULT5-i5/P/PC/4G-R10	Wide 15.6" 300cd/m ² 1366x768 Panel PC with 8th generation 14nm Intel® Whiskey Lake Core™ i5-8365UE (15W) on-board processor (ULT), PoE option, 802.11a/b/g/n/ac Wi-Fi module, PCAP touch, 2M camera, microphone, 1*4GB DDR4 RAM, with AG, R10
AFL3-W19C-ULT5-i5/P/PC/4G-R10	Wide 18.5" 250cd/m ² 1366x768 Panel PC with 8th generation 14nm Intel® Whiskey Lake Core™ i5-8365UE (15W) on-board processor (ULT), PoE option, 802.11a/b/g/n/ac Wi-Fi module, PCAP touch, 2M camera, microphone, 1*4GB DDR4 RAM, with AG, R10
AFL3-W22C-ULT5-i5/P/PC/4G-R10	Wide 21.5" 250cd/m ² 1920x1080 Panel PC with 8th generation 14nm Intel® Whiskey Lake Core™ i5-8365UE (15W) on-board processor (ULT), PoE option, 802.11a/b/g/n/ac Wi-Fi module, PCAP touch, 2M camera, microphone, 1*4GB DDR4 RAM, with AG, R10
GPOE-PD-BT01-R10	PoE PD IEEE802.3af/at/bt with PCIe Mini form factor, supports AFL3-W15C/W19C/W22C-ULT5, R10

Options

Item	AFL3-W15C-ULT5	AFL3-W19C-ULT5	AFL3-W22C-ULT5
Panel Mounting Kit	AFL3PK-W15A-R10	AFL3PK-W19C-R10	AFL3PK-W19C-R10
Wall Mounting Kit	AFLWK-19B		
Rack Mounting Kit	N/A	N/A	N/A
Arm	ARM-11-RS/ARM-31-RS		
Stand	STAND-A21-R10/ STAND-210-R11/STAND-C19-R10		
Barcode Scanner	AFL3-2D-R11		
RFID Reader (13.56 MHz Mifare Type For ATO assembly)	AFL3-MF-RFID-KIT02-R11		

Packing List

Item	Part No.	Q'ty	Remark
Round head machine screw	44003-020041-RS	2	M2*4 round head machine screw
	44003-020041-RS	4	M2*4 round head machine screw
Pan head machine screw	44403-040061-RS	4	M4*6 pan head machine screw
Fix holder	46003-009500-RS	2	
Power cord	32702-000400-200-RS	1	
Power adapter	63040-010096-200-RS	1	Vin: 90~264VAC; 96W, Vout: 12VDC; Din 4Pin/lock

AFL3-W15C-ULT5
Fully Integrated I/O

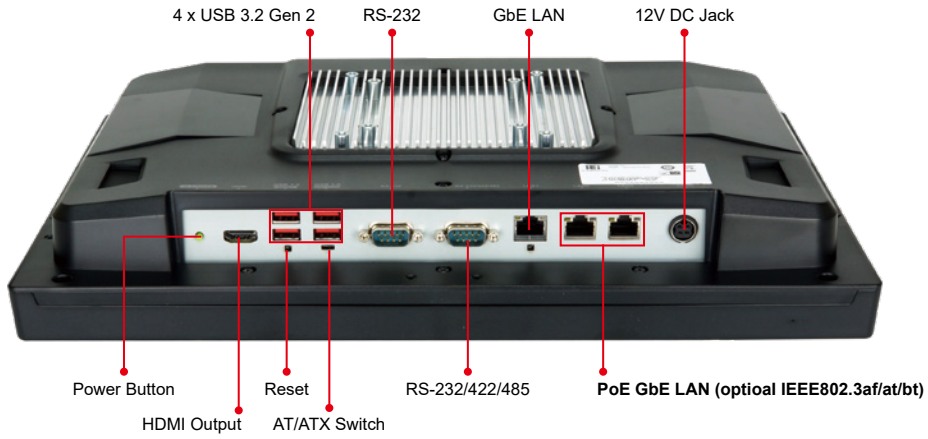

AFL3-W19C-ULT5
Fully Integrated I/O

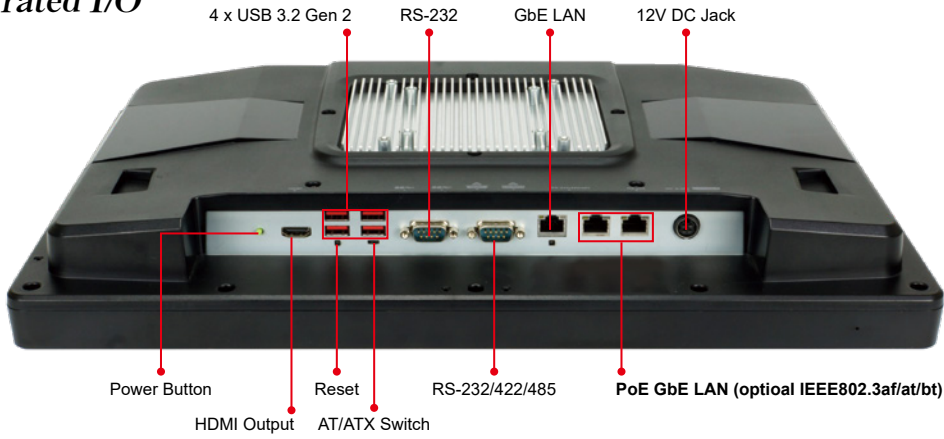

AFL3-W22C-ULT5
Fully Integrated I/O

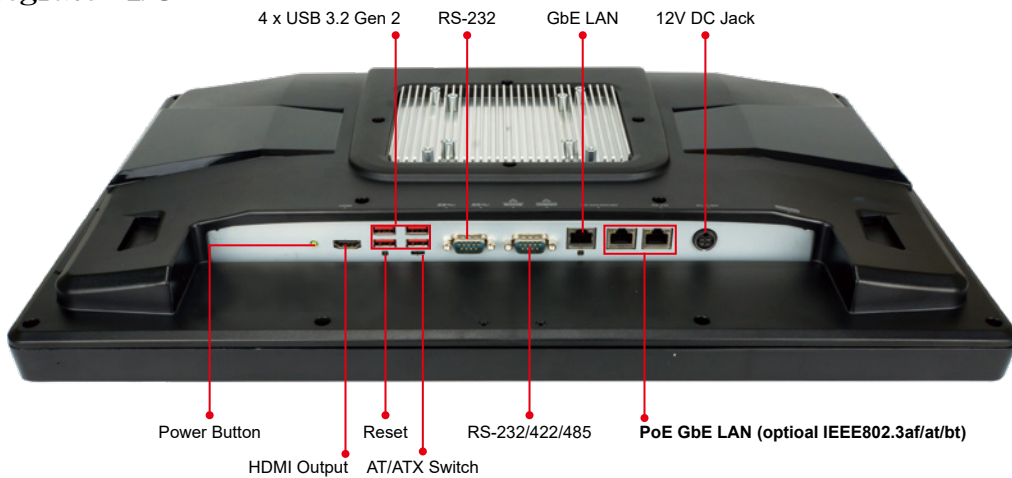

AFL3-W15C-ULT5 Dimensions (Unit: mm)

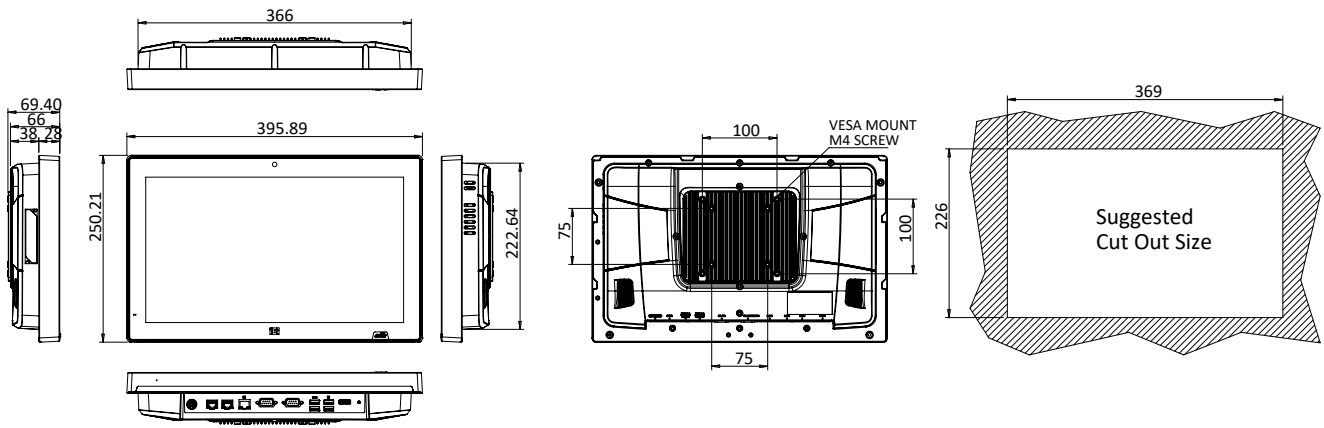

AFL3-W19C-ULT5 Dimensions (Unit: mm)

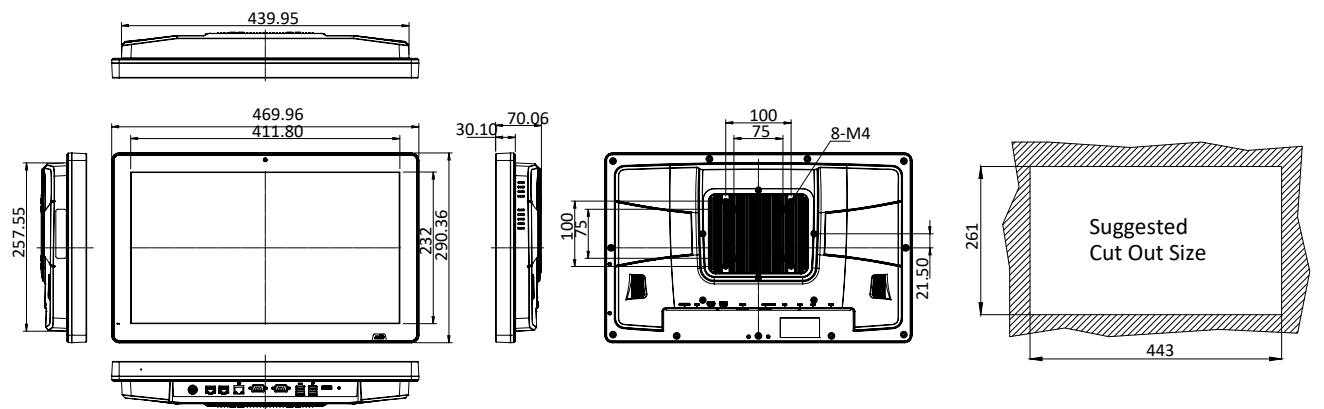

AFL3-W22C-ULT5 Dimensions (Unit: mm)

