



**MODEL:
ITG-100-AL**

**Fanless Embedded System with Intel® Atom™ x5-E3930,
VGA , GbE, Two RS-232/422/485,
Two USB 3.0 and RoHS Compliant**

User Manual

Revision

Date	Version	Changes
4 December 2018	1.00	Initial release

Copyright

COPYRIGHT NOTICE

The information in this document is subject to change without prior notice in order to improve reliability, design and function and does not represent a commitment on the part of the manufacturer.

In no event will the manufacturer be liable for direct, indirect, special, incidental, or consequential damages arising out of the use or inability to use the product or documentation, even if advised of the possibility of such damages.

This document contains proprietary information protected by copyright. All rights are reserved. No part of this manual may be reproduced by any mechanical, electronic, or other means in any form without prior written permission of the manufacturer.

TRADEMARKS

All registered trademarks and product names mentioned herein are used for identification purposes only and may be trademarks and/or registered trademarks of their respective owners.

Manual Conventions



WARNING

Warnings appear where overlooked details may cause damage to the equipment or result in personal injury. Warnings should be taken seriously.



CAUTION

Cautionary messages should be heeded to help reduce the chance of losing data or damaging the product.



NOTE

These messages inform the reader of essential but non-critical information. These messages should be read carefully as any directions or instructions contained therein can help avoid making mistakes.



HOT SURFACE

This symbol indicates a hot surface that should not be touched without taking care.

Table of Contents

1 INTRODUCTION	2
1.1 OVERVIEW.....	3
1.2 MODEL VARIATIONS.....	3
1.3 FEATURES.....	4
1.4 TECHNICAL SPECIFICATIONS.....	4
1.5 SIDE PANEL.....	6
1.6 FRONT PANEL.....	6
1.7 PHYSICAL DIMENSIONS.....	8
1.7.1 ITG-100-AL-E1 Physical Dimensions	8
1.7.1 ITG-100-AL-E1/S Physical Dimensions	9
2 UNPACKING	10
2.1 UNPACKING.....	11
2.2 PACKING LIST.....	11
3 INSTALLATION	13
3.1 ANTI-STATIC PRECAUTIONS.....	14
3.2 INSTALLATION PRECAUTIONS	14
3.3 INSTALLATION AND CONFIGURATION STEPS	15
3.4 HARD DISK DRIVE (HDD) INSTALLATION (ITG-100-AL-E1 ONLY).....	15
3.5 SO-DIMM INSTALLATION.....	17
3.6 WIRELESS LAN MODULE INSTALLATION (OPTIONAL).....	18
3.7 ADDITIONAL BLOCK LAYER INSTALLATION	21
3.8 AT/ATX MODE SELECTION.....	24
3.8.1 AT Power Mode.....	24
3.8.2 ATX Power Mode	24
3.9 RESET THE SYSTEM.....	25
3.10 POWERING ON/OFF THE SYSTEM	25
3.11 MOUNTING THE SYSTEM.....	26
3.11.1 Mounting the System with DIN Rail Mounting Kit	26
3.12 RS-232/422/485 SERIAL PORT CONNECTION.....	27

3.12.1 DB-9 RS-232/422/485 Serial Port Connection.....	27
3.12.2 RJ-45 RS-232/422/485 Serial Port Connection.....	28
4 SYSTEM MOTHERBOARD.....	31
4.1 OVERVIEW.....	32
4.1.1 Layout	32
4.2 INTERNAL PERIPHERAL CONNECTORS.....	33
4.2.1 Battery Connector (BT1).....	33
4.2.2 BIOS Programming Connector (J_SPI1)	33
4.2.3 Debug Connector (DBG_PORT1).....	34
4.2.4 DIO Connector (J_DIO2).....	34
4.2.5 EC ROM Flash Connector (EC_JP1).....	34
4.2.6 RS-232 Serial Port Connector (COM3).....	34
4.2.7 RS-232 Serial Port Connector (COM4).....	35
4.2.8 SMBUS/I2C Connector (J_SMB2).....	35
4.2.9 SATA 6Gb/s Drive Connectors (SATA1).....	35
4.2.10 SATA Power Connector (SATA_PWR1).....	35
4.2.11 Micro SD Connector (SD1).....	36
4.3 EXTERNAL INTERFACE PANEL CONNECTORS.....	36
4.3.1 Ethernet Connector (LAN1).....	36
4.3.2 Ethernet Connector (LAN2).....	37
4.3.3 Power Button (SW1)	37
4.3.4 DC-IN Connector (PWR1).....	37
4.3.5 RS-232/422/485 Connector (COM1).....	38
4.3.6 RJ45 to RS-232/422/485 Connector (COM2).....	38
4.3.7 USB 3.0 Connectors (CON1).....	38
4.3.8 VGA Connector (VGA1).....	39
4.4 JUMPER SETTINGS.....	39
4.4.1 AT/ATX Mode Select Switch (J_ATX_AT1).....	39
4.4.2 Clear CMOS Button (J_CMOS1).....	40
4.4.3 System Reset Button (RST1).....	40
4.4.4 Flash Descriptor Security Override Jumper Settings (J_TXE1).....	40
5 BIOS	41
5.1 INTRODUCTION	42

ITG-100-AL Embedded System

5.1.1 Starting Setup.....	42
5.1.2 Using Setup.....	42
5.1.3 Getting Help.....	43
5.1.4 Unable to Reboot after Configuration Changes.....	43
5.1.5 BIOS Menu Bar.....	43
5.2 MAIN.....	44
5.3 ADVANCED.....	45
5.3.1 ACPI Settings.....	46
5.3.2 F81866 Super IO Configuration.....	47
5.3.2.1 Serial Port n Configuration.....	47
5.3.3 Hardware Monitor.....	49
5.3.4 RTC Wake Settings.....	50
5.3.5 Serial Port Console Redirection.....	52
5.3.5.1 Console Redirection Settings.....	52
5.3.6 CPU Configuration.....	55
5.3.7 USB Configuration.....	56
5.3.8 iEi Feature.....	57
5.3.9 SATA Configuration.....	58
5.4 CHIPSET.....	59
5.4.1 North Bridge Configuration.....	60
5.4.1.1 Intel IGD Configuration.....	60
5.4.2 Southbridge Configuration.....	62
5.4.2.1 PCI Express Configuration.....	63
5.4.2.2 SCC Configuration.....	64
5.5 SECURITY.....	65
5.6 BOOT.....	66
5.7 EXIT.....	68
6 SOFTWARE INSTALLATION.....	70
6.1.1 Available Drivers.....	71
6.1.2 Driver Download.....	71
A REGULATORY COMPLIANCE.....	73
B SAFETY PRECAUTIONS.....	79
B.1 SAFETY PRECAUTIONS.....	80

<i>B.1.1 General Safety Precautions</i>	80
<i>B.1.2 Anti-static Precautions</i>	81
<i>B.1.3 Product Disposal</i>	82
<i>B.2 MAINTENANCE AND CLEANING PRECAUTIONS</i>	83
<i>B.2.1 Maintenance and Cleaning</i>	83
<i>B.2.2 Cleaning Tools</i>	83
<i>C BIOS MENU OPTIONS</i>	85
<i>D TERMINOLOGY</i>	88
<i>E HAZARDOUS MATERIALS DISCLOSURE</i>	92

List of Figures

Figure 1-1: ITG-100-AL	3
Figure 1-2: ITG-100-AL Side Panel.....	6
Figure 1-3: ITG-100-AL Front Panel	7
Figure 1-4: ITG-100-AL-E1 Physical Dimensions (mm)	8
Figure 1-5: ITG-100-AL-E1/S Physical Dimensions (mm).....	9
Figure 3-1: Remove the Bottom Panel.....	15
Figure 3-2: HDD Bracket	16
Figure 3-3: Install the HDD.....	16
Figure 3-4: SO-DIMM Socket	17
Figure 3-5: SO-DIMM Installation	18
Figure 3-6: Knockout Holes for Wireless Antenna.....	19
Figure 3-7: M.2 A key Slot Location.....	19
Figure 3-8: Inserting the WLAN Module	20
Figure 3-9: Securing WLAN Module and Connecting RF Cables	20
Figure 3-10: Securing SMA Connector and External Antenna Installation	21
Figure 3-11: Remove the Bottom Panel (ITG-100-AL-E1/S).....	22
Figure 3-12: Additional Block Layer Installation	22
Figure 3-13: HDD Bracket Installation	23
Figure 3-14: Reinstall the Bottom Panel (ITG-100-AL-E1)	23
Figure 3-15: AT/ATX Switch Location.....	24
Figure 3-16: Reset Button Location.....	25
Figure 3-17: Power Button Location.....	26
Figure 3-18: Mounting the DIN Rail.....	26
Figure 3-19: Mounting the Track to the DIN Rail	27
Figure 3-20: Serial Device Connector.....	28
Figure 3-21: DB-9 RS-232/422/485 Serial Port Connector	28
Figure 3-22: Serial Device Connector.....	29
Figure 3-23: RJ-45 RS-232/422/485 Serial Port Connector.....	29
Figure 3-24: DB-9 RS-232/422/485 Connector Pinout Location	30
Figure 4-1: System Motherboard (Front).....	32

Figure 4-2: System Motherboard (Rear)	32
Figure 6-1: IEI Resource Download Center	71

List of Tables

Table 1-1: ITG-100-AL Model Variations.....	3
Table 1-2: Technical Specifications.....	5
Table 2-1: Package List Contents	12
Table 3-1: RJ-45 RS-232/422/485 Serial Port Pinouts	29
Table 3-2: DB-9 RS-232/422/485 Connector Pinouts.....	30
Table 4-1: Peripheral Interface Connectors	33
Table 4-2: Battery Connector Pinouts (BAT1)	33
Table 4-3: BIOS Programming Connector Pinouts (J_SPI1).....	33
Table 4-4: Debug Connector Pinouts (DBG_PORT1).....	34
Table 4-5: DIO Connector Pinouts (J_DIO2)	34
Table 4-6: EC ROM Flash Connector Pinouts (EC_JP1).....	34
Table 4-7: RS-232 Serial Port Connector Pinouts (COM3)	35
Table 4-8: RS-232 Serial Port Connector Pinouts (COM4)	35
Table 4-9: SMBUS/I2C Connector Pinouts (J_SMB2)	35
Table 4-10: SATA 6Gb/s Drive Connectors Pinouts (SATA1)	35
Table 4-11: SATA Power Connector Pinouts (SATA_PWR1).....	35
Table 4-12: Micro SD Connector Pinouts (SD1)	36
Table 4-13: Rear Panel Connectors	36
Table 4-14: Ethernet Connector Pinouts (LAN1)	37
Table 4-15: Ethernet Connector Pinouts (LAN2)	37
Table 4-16: Power Button Pinouts (SW1).....	37
Table 4-17: DC-IN Connector Pinouts (PWR1).....	37
Table 4-18: RS-232/422/485 Connector (COM1).....	38
Table 4-19: RS-232/422/485 Connector (COM2).....	38
Table 4-20: USB 3.0 Connectors Pinouts (CON1)	39
Table 4-21: VGA Connector Pinouts (VGA1)	39
Table 4-22: Buttons, Jumper and Switch	39
Table 4-23: AT/ATX Mode Select Switch (J_ATX_AT1).....	39
Table 4-24: Clear CMOS Button (J_CMOS1).....	40
Table 4-25: System Reset Button (RST1).....	40

Table 4-26: Flash Descriptor Security Override Jumper Settings (J_TXE1).....	40
Table 5-1: BIOS Navigation Keys	43

BIOS Menus

BIOS Menu 1: Main	44
BIOS Menu 2: Advanced	45
BIOS Menu 3: ACPI Configuration	46
BIOS Menu 4: Super IO Configuration.....	47
BIOS Menu 5: Serial Port 1 Configuration Menu	47
BIOS Menu 6: Hardware Monitor.....	50
BIOS Menu 7: RTC Wake Settings	51
BIOS Menu 8: Serial Port Console Redirection	52
BIOS Menu 9: Console Redirection Settings.....	53
BIOS Menu 10: CPU Configuration	55
BIOS Menu 11: USB Configuration	56
BIOS Menu 12: iEi Feature	57
BIOS Menu 13: IDE Configuration.....	58
BIOS Menu 14: Chipset	59
BIOS Menu 15: Northbridge Chipset Configuration.....	60
BIOS Menu 16: Integrated Graphics	61
BIOS Menu 17: Southbridge Chipset Configuration	62
BIOS Menu 18: PCI Express Configuration	63
BIOS Menu 19: PCI Express Configuration	64
BIOS Menu 20: Security	65
BIOS Menu 21: Boot	66
BIOS Menu 22:Exit.....	68

Chapter

1

Introduction

ITG-100-AL Embedded System

1.1 Overview



Figure 1-1: ITG-100-AL

The ITG-100-AL embedded system is a fanless system with one VGA port for display. It accepts an Intel® Atom™ x5-E3930 processor and supports one 204-pin DDR3L SO-DIMM module up to 8 GB (ITG-100-AL-E1/2GB/S and ITG-100-AL-E1/2GB SKUs are pre-installed with 2 GB memory). Two RS-232/422/485 serial ports and two USB 3.0 ports ensure simplified connectivity to a variety of external peripheral devices.

1.2 Model Variations

The model variations of the ITG-100-AL series are listed below.

Model No.	2GB DDR3L Pre-installed Memory	Flexible I/O Expansion
ITG-100-AL-E1	No	Yes
TG-100-AL-E1/2GB	Yes	Yes
ITG-100-AL-E1/2GB/S	Yes	No
ITG-100-AL-E1/S	No	No

Table 1-1: ITG-100-AL Model Variations

1.3 Features

The ITG-100-AL features are listed below:

- Intel® Atom™ x5-E3930 1.3GHz (up to 1.8 GHz)
- Two GbE LAN ports
- Two RS-232/422/485
- Full-size PCIe Mini slot and M.2 A-key slot for expansion

1.4 Technical Specifications

The ITG-100-AL technical specifications are listed in **Table 1-2**.

Model Name	ITG-100-AL-E1/S	ITG-100-AL-E1
Chassis		
Color	Blue & Silver	
Dimensions (WxDxH)	137 x 102.8 x 36.2 (mm)	137 x 102.8 x 56.2 (mm)
System Fan	Fanless	
C6	Extruded aluminum alloy	
Motherboard		
CPU	Intel® Atom™ x5-E3930 1.3 GHz (up to 1.8GHz, dual-core, TDP=6.5W)	
Chipset	SoC	
System Memory	1x 204-pin DDR3L SO-DIMM slot (system max. 8 GB) (ITG-100-AL-E1/2GB/S-R10 SKU is pre-installed with 2 GB memory)	1x 204-pin DDR3L SO-DIMM slot (system max. 8 GB) (ITG-100-AL-E1/2GB-R10 SKU is pre-installed with 2 GB memory)
Storage		
Hard Drive	N/A	1 x 2.5" SATA 6Gb/s HDD/SSD bay
eMMC	1 x eMMC 5.0 support (up to 32GB optional)	
Micro SD	1 x Micro SD Slot (optional)	
I/O Interfaces		
USB 3.0	2 x USB 3.0 ports	

ITG-100-AL Embedded System

USB 2.0	2 x USB 2.0 ports by pin-header (optional)
Ethernet	2 x RJ-45 PCIe GbE by I211-AT controller
COM Port	2 x RS-232/422/485 (DB-9/RJ45) 2 x RS-232 by pin-header (optional)
Digital I/O	8-bit digital I/O, 4-bit input/4-bit output by pin-header (optional)
Display	1 x VGA
Resolution	Up to 1920x1080@60Hz
Wireless	1 x 802.11a/b/g/n/ac (optional)
Others	1 x Power Button, 1 x Reset Button, 1 x AT/ATX Switch, 1 x LED for HDD (Yellow), 1 x LED for Power (Green)
Expansions	
M.2	1 x M.2 2230 (A key, PCIe by 1, USB2.0)
PCIe Mini	1 x Full-size PCIe Mini slot (supports mSATA, colay with SATA)
Power	
Power Input	2-pin terminal block: 12 V DC
Power Consumption	12V @ 1A (Intel® Atom™ E3930 with 2GB memory)
Reliability	
Mounting	DIN-rail / Wall mounting
Operating Temperature	-20°C ~ 60°C with air flow (SSD), 10% ~ 95%, non-condensing
Storage Temperature	-30°C ~ 70°C with air flow (SSD), 10% ~ 90%, non-condensing
Operating Shock	Half-sine wave shock 5G, 11ms, 100 shocks per axis, IEC68-2-27
Operating Vibration	MIL-STD-810G 514.6C-1 (SSD)
Safety / EMC	CE/FCC
Watchdog Timer	Programmable 1~255 sec/min
OS	
Supported OS	Microsoft® Windows 10 / Linux

Table 1-2: Technical Specifications

1.5 Side Panel

The side panel of the ITG-100-AL has the following features (**Figure 1-2**):

- 1 x 12V DC IN
- 1 x VGA connector



Figure 1-2: ITG-100-AL Side Panel

1.6 Front Panel

The front panel of the ITG-100-AL has the following features (**Figure 1-3**):

- 1 x AT/ATX Switch
- 1 x HDD LED
- 1 x Power button
- 1 x Power LED
- 1 x Reset button
- 2 x RJ-45 LAN connectors
- 2 x RS-232/422/485 serial port connectors (DB-9/RJ45)
- 2 x USB 3.0 connectors

ITG-100-AL Embedded System

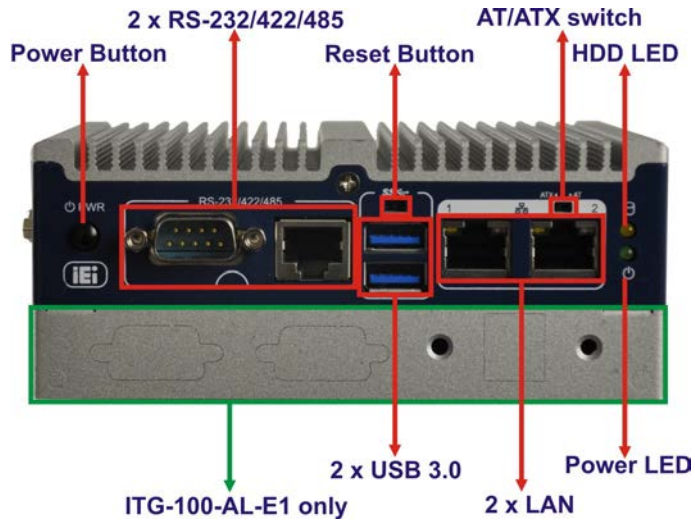

Figure 1-3: ITG-100-AL Front Panel

1.7 Physical Dimensions

1.7.1 ITG-100-AL-E1 Physical Dimensions

The physical dimensions of the ITG-100-AL-E1 are shown below:

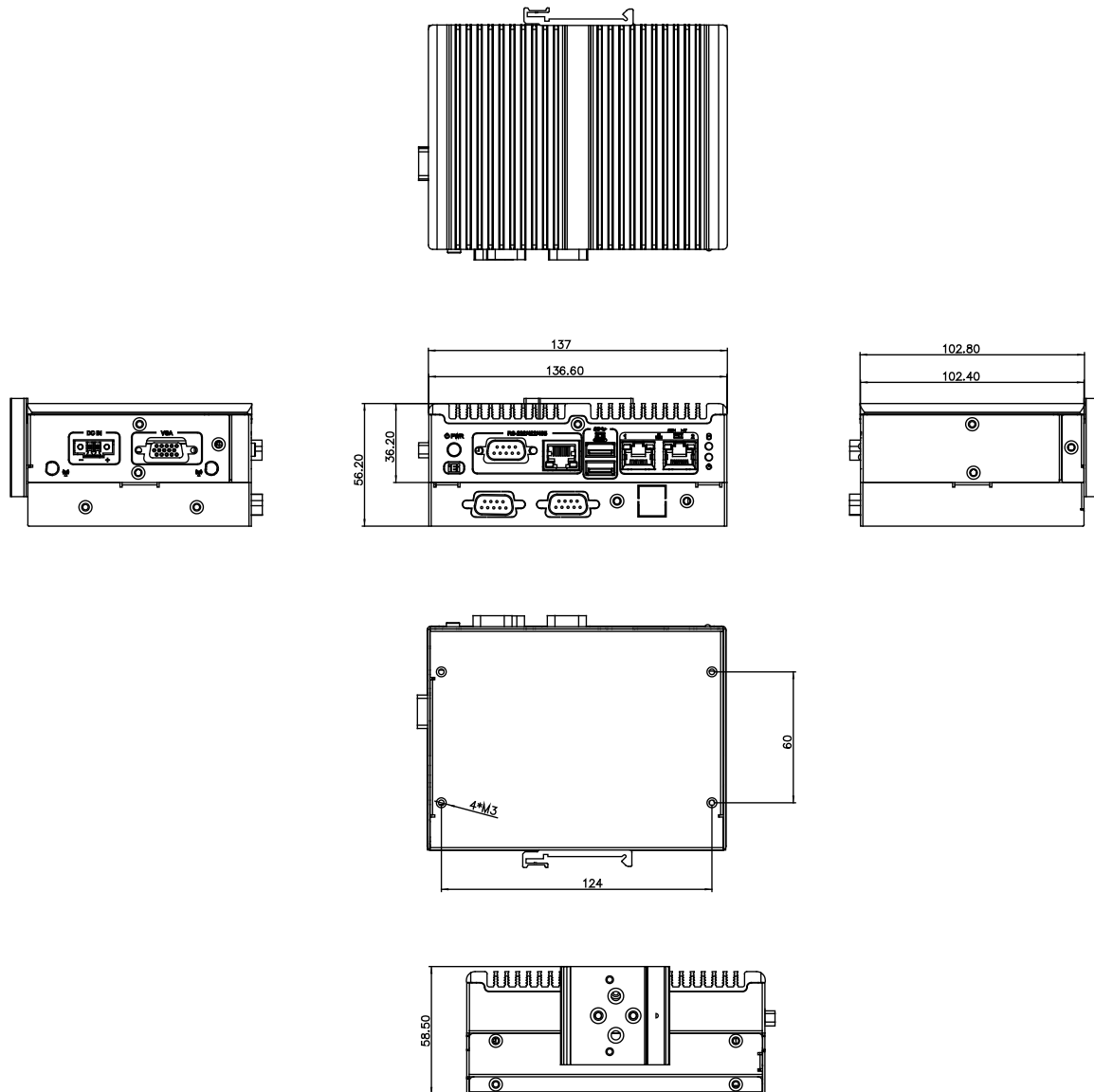

Figure 1-4: ITG-100-AL-E1 Physical Dimensions (mm)

ITG-100-AL Embedded System

1.7.1 ITG-100-AL-E1/S Physical Dimensions

The physical dimensions of the ITG-100-AL-E1/S are shown below:

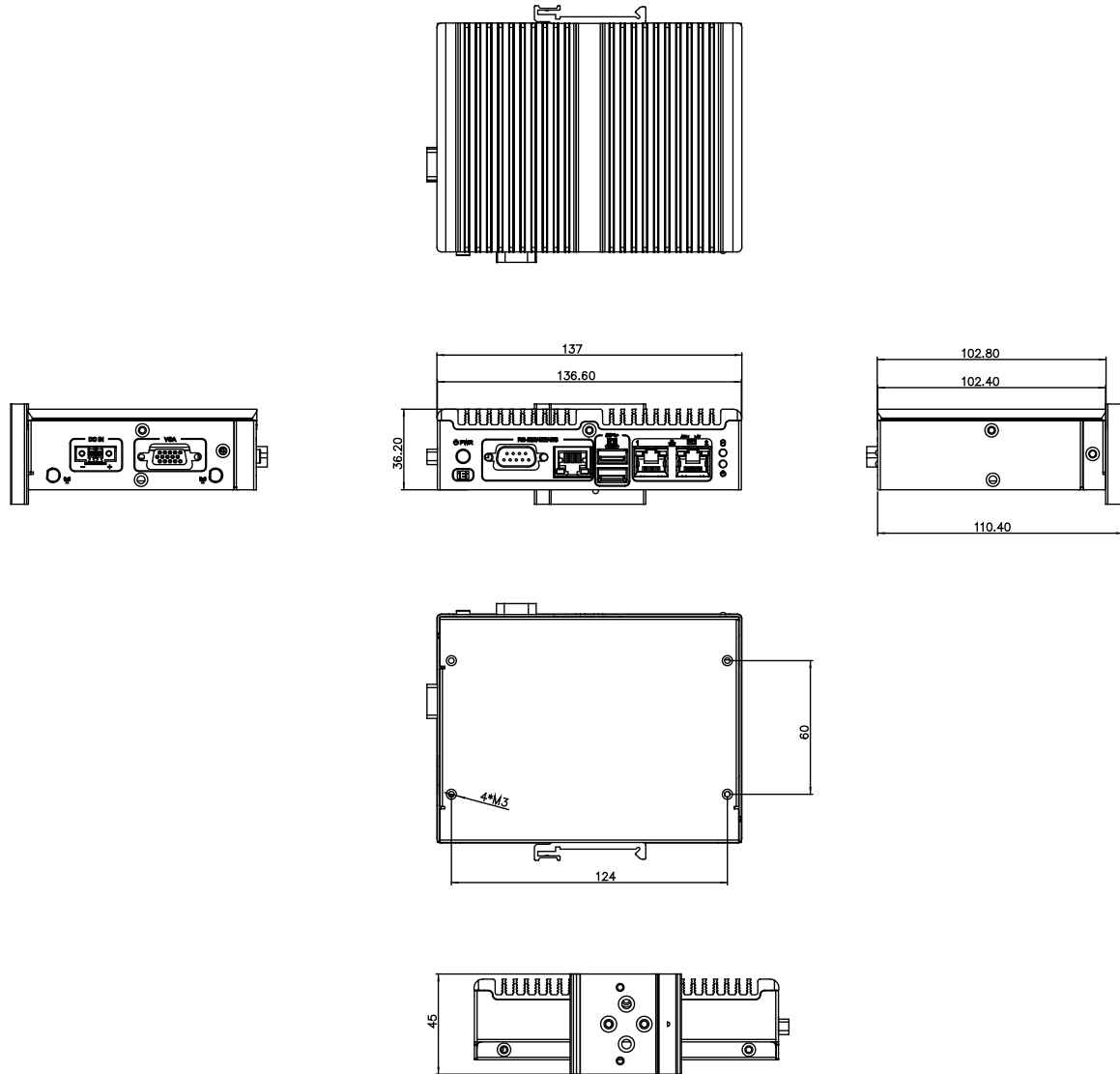

Figure 1-5: ITG-100-AL-E1/S Physical Dimensions (mm)

Chapter

2

Unpacking

ITG-100-AL Embedded System

2.1 Unpacking

To unpack the embedded system, follow the steps below:

- Step 1:** Use box cutters, a knife or a sharp pair of scissors that seals the top side of the external (second) box.
- Step 2:** Open the external (second) box.
- Step 3:** Use box cutters, a knife or a sharp pair of scissors that seals the top side of the internal (first) box.
- Step 4:** Lift the system out of the boxes.
- Step 5:** Remove both polystyrene ends, one from each side.
- Step 6:** Make sure all the components listed in the packing list are present.

2.2 Packing List



NOTE:

If some of the components listed in the checklist below are missing, please do not proceed with the installation. Contact the IEI reseller or vendor you purchased the ITG-100-AL from or contact an IEI sales representative directly. To contact an IEI sales representative, please send an email to sales@iei.com.tw.

The ITG-100-AL is shipped with the following components:

Quantity	Item and Part Number	Image
1	ITG-100-AL	



Quantity	Item and Part Number	Image
1	SATA cable & SATA power cable (for ITG-100-AL-E1 only)	
1	Mounting Bracket	

Table 2-1: Package List Contents

Chapter

3

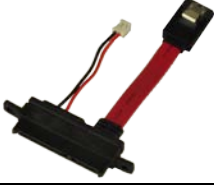
Installation

3.1 Anti-static Precautions

**WARNING:**

Failure to take ESD precautions during the maintenance of the ITG-100-AL may result in permanent damage to the ITG-100-AL and severe injury to the user.

Electrostatic discharge (ESD) can cause serious damage to electronic components, including the WAFER series motherboard and the power module. (Dry climates are especially susceptible to ESD.) It is therefore critical that whenever the ITG-100-AL is opened and any electrical component handled, the following anti-static precautions are strictly adhered to.

- **Wear an anti-static wristband:** Wearing a simple anti-static wristband can help to prevent ESD from damaging the board.
- **Self-grounding:** Before handling the board, touch any grounded conducting material. During the time the board is handled, frequently touch any conducting materials that are connected to the ground.
- **Use an anti-static pad:** When configuring the ITG-100-AL, place it on an anti-static pad. This reduces the possibility of ESD damaging the ITG-100-AL.

3.2 Installation Precautions

During installation, be aware of the precautions below:

- **Read the user manual:** The user manual provides a complete description of the ITG-100-AL, installation instructions and configuration options.
- **DANGER! Disconnect Power:** Power to the ITG-100-AL must be disconnected during the installation process, or before any attempt is made to access the rear panel. Electric shock and personal injury might occur if the rear panel of the ITG-100-AL is opened while the power cord is still connected to an electrical outlet.

ITG-100-AL Embedded System

- **Qualified Personnel:** The ITG-100-AL must be installed and operated only by trained and qualified personnel. Maintenance, upgrades, or repairs may only be carried out by qualified personnel who are familiar with the associated dangers.
- **Air Circulation:** Make sure there is sufficient air circulation when installing the ITG-100-AL. The ITG-100-AL's cooling vents must not be obstructed by any objects. Blocking the vents can cause overheating of the ITG-100-AL. Leave at least 5 cm of clearance around the ITG-100-AL to prevent overheating.
- **Grounding:** The ITG-100-AL should be properly grounded. The voltage feeds must not be overloaded. Adjust the cabling and provide external overcharge protection per the electrical values indicated on the label attached to the back of the ITG-100-AL.

3.3 Installation and Configuration Steps

3.4 Hard Disk Drive (HDD) Installation (ITG-100-AL-E1 only)

To install the hard drive, please follow the steps below:

- Step 1:** Remove the bottom panel by removing the two retention screws from the bottom panel (**Figure 3-1**).



Figure 3-1: Remove the Bottom Panel

Step 2: Open the bottom cover and remove the three retention screws from the HDD bracket (**Figure 3-2**).

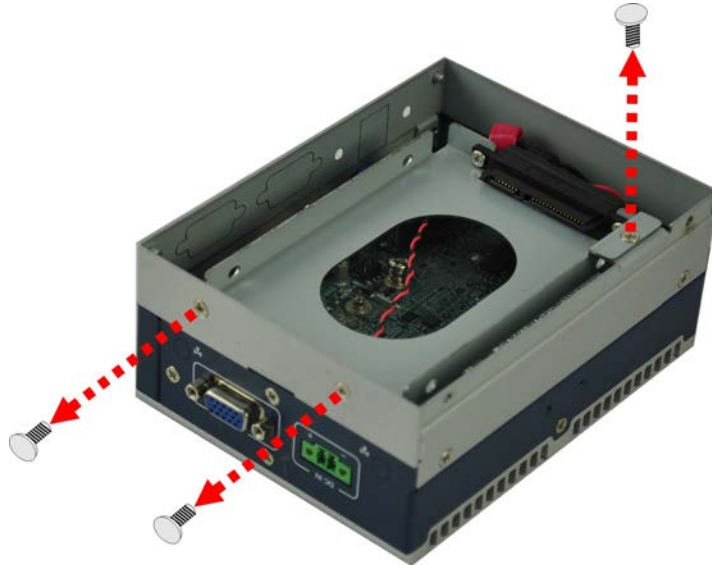

Figure 3-2: HDD Bracket

Step 3: Attach the HDD to the HDD bracket. Secure the HDD with the HDD bracket by four retention screws (**Figure 3-3**).



Figure 3-3: Install the HDD

ITG-100-AL Embedded System

Step 4: Secure the HDD bracket with the system by the three retention screws that were previously removed.

Step 5: Reinstall the bottom panel to the system.

3.5 SO-DIMM Installation



WARNING:

Using incorrectly specified SO-DIMM may cause permanently damage the ITG-100-AL. Please make sure the purchased SO-DIMM complies with the memory specifications of the ITG-100-AL.

To install a SO-DIMM into a SO-DIMM socket, please follow the steps below.

Step 1: Remove the bottom panel by removing the two retention screws from the bottom panel (**Figure 3-1**).

Step 2: Locate the SO-DIMM socket on the motherboard (**Figure 3-4**).



Figure 3-4: SO-DIMM Socket

Step 3: Align the SO-DIMM with the socket. The SO-DIMM must be oriented in such a way that the notch in the middle of the SO-DIMM must be aligned with the plastic bridge in the socket (**Figure 3-5**).

Step 4: Push the SO-DIMM into the socket at an angle (**Figure 3-5**).

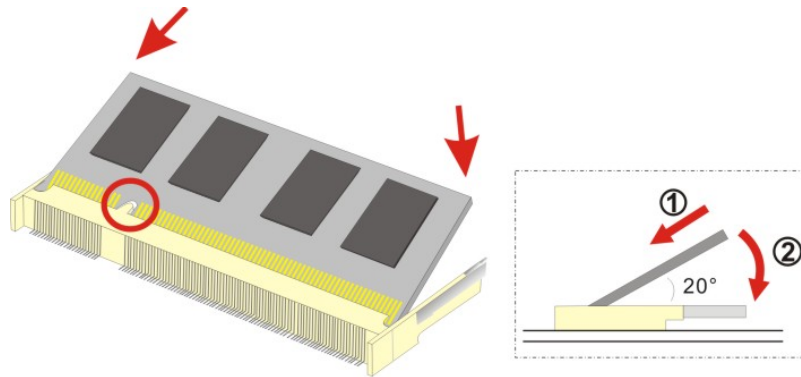

Figure 3-5: SO-DIMM Installation

- Step 5:** Gently pull the arms of the SO-DIMM socket out and push the rear of the SO-DIMM down (**Figure 3-5**).
- Step 6:** Release the arms on the SO-DIMM socket. They clip into place and secure the SO-DIMM in the socket.
- Step 7:** Install the bracket that was previously removed in the same position it was before.
- Step 8:** Reinstall the bottom panel to the ITG-100-AL.

3.6 Wireless LAN Module Installation (Optional)

To install the optional wireless LAN (WLAN) module, please follow the steps below.

- Step 1:** Remove the bottom panel by removing the two retention screws from the bottom panel (**Figure 3-1**).
- Step 2:** **Remove the two knockout holes** for antenna installation. The two knockout holes are located on the rear panel of the ITG-100-AL as shown in **Figure 3-6**.

ITG-100-AL Embedded System



Figure 3-6: Knockout Holes for Wireless Antenna

Step 3: Locate the M.2 A key slot. Remove the on-board retention screw. (Figure 3-7)

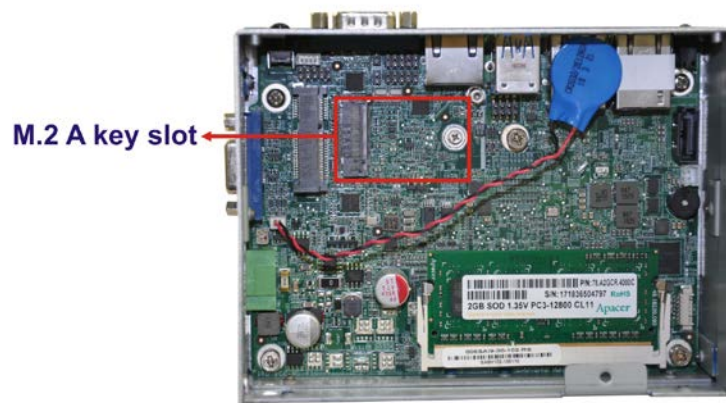

Figure 3-7: M.2 A key Slot Location

Step 4: Insert into the socket at an angle. Line up the notch on the WLAN module with the notch on the slot. Slide the WLAN module into the slot at an angle of about 20° (Figure 3-8).

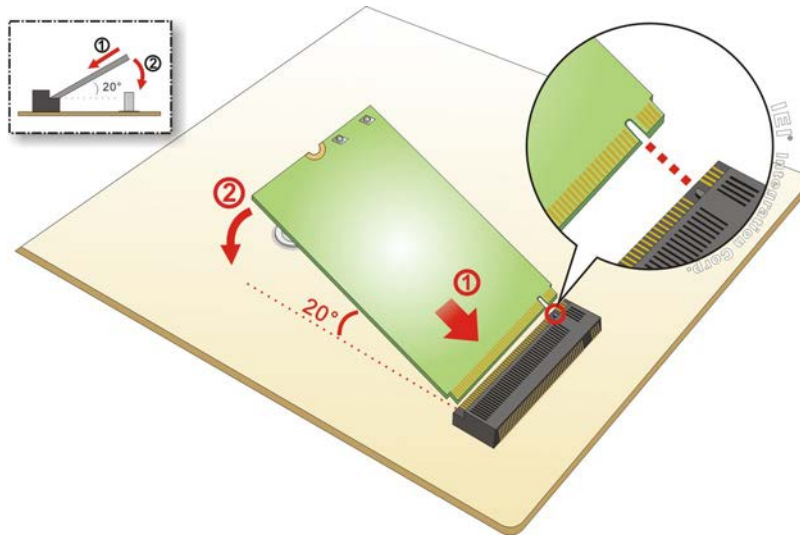

Figure 3-8: Inserting the WLAN Module

- Step 5:** **Secure the WLAN module.** Secure the WLAN module with the retention screw previously removed (**Figure 3-9**).
- Step 6:** **Connect the two RF cables** to the antenna connectors on the WLAN module (**Figure 3-9**).

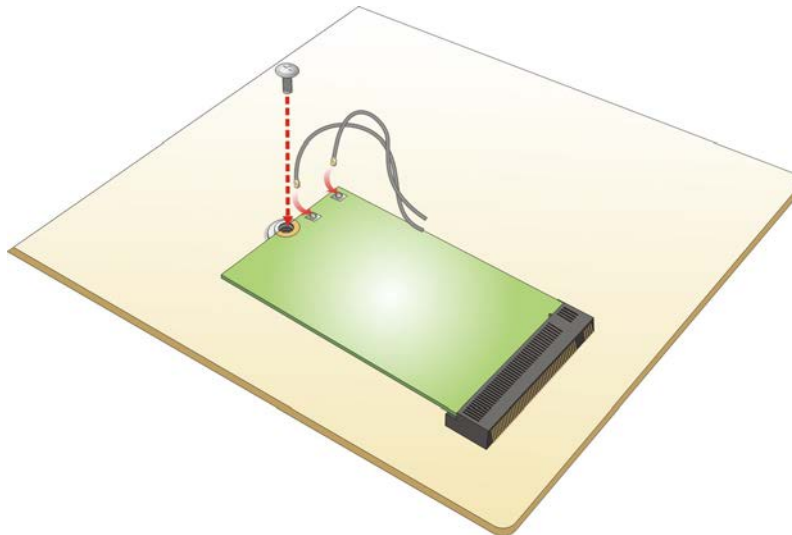

Figure 3-9: Securing WLAN Module and Connecting RF Cables

- Step 7:** **Remove the nut and washer** from the SMA connector at the other end of the RF cable.

ITG-100-AL Embedded System

Step 8: Insert the SMA connector to the antenna connector holes on the side panel.

Step 9: Secure the SMA connector by inserting the washer and tightening it with nut.

Step 10: Install the external antenna.

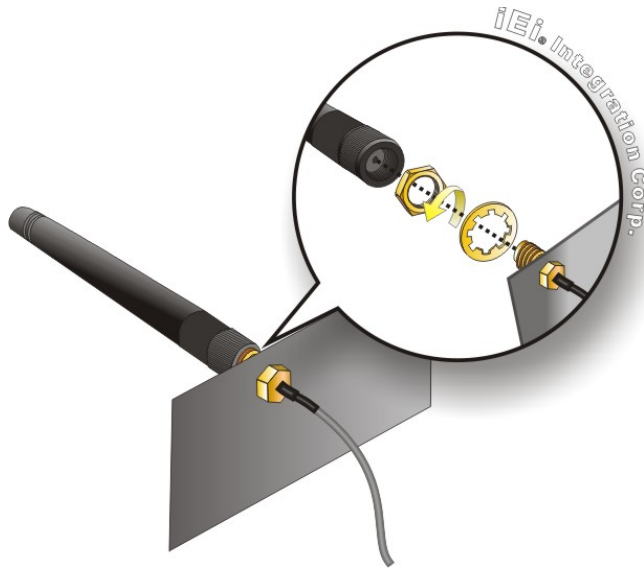

Figure 3-10: Securing SMA Connector and External Antenna Installation

3.7 Additional Block Layer Installation



NOTE:

Additional block layer can be assembled to achieve I/O interface expansion and data storage requirement. With choices of adding a 2.5" SATA HDD/SSD bay, a knockout-hole layer with selectable I/O interface, or both of above-mentioned options, the ITG-100-AL could be modularized to what best fit users' preferences and still remaining its compact size.

To install the additional block layer, please follow the steps below:

Step 1: Remove the bottom panel by removing the two retention screws from the bottom panel (**Figure 3-11**).



Figure 3-11: Remove the Bottom Panel (ITG-100-AL-E1/S)

Step 2: Install the additional block layer by securing the four retention screws. (Figure 3-12).



Figure 3-12: Additional Block Layer Installation

Step 3: Install the HDD bracket by securing the three retention screws (Figure 3-13).

ITG-100-AL Embedded System



Figure 3-13: HDD Bracket Installation

Step 4: Reinstall the bottom panel by securing the two retention screws (Figure 3-14).



Figure 3-14: Reinstall the Bottom Panel (ITG-100-AL-E1)

3.8 AT/ATX Mode Selection

AT or ATX power mode can be used on the ITG-100-AL. The selection is made through an AT/ATX switch located on the front panel (Figure 3-15). To select AT mode or ATX mode, follow the steps below.

Step 1: Locate the AT/ATX switch on the front panel (Figure 3-15).

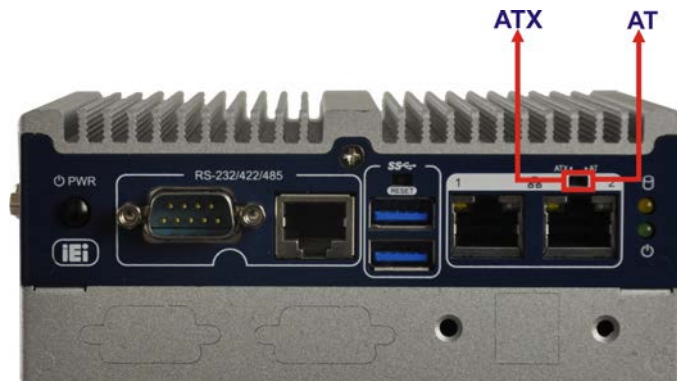

Figure 3-15: AT/ATX Switch Location

Step 2: Adjust the AT/ATX switch.

3.8.1 AT Power Mode

With the AT mode selected, the power is controlled by a central power unit rather than a power switch. The ITG-100-AL panel PC turns on automatically when the power is connected. The AT mode benefits a production line to control multiple panel PCs from a central management center and other applications including:

- ATM
- Self-service kiosk
- Plant environment monitoring system
- Factory automation platform
- Manufacturing shop flow

3.8.2 ATX Power Mode

With the ATX mode selected, the ITG-100-AL panel PC goes in a standby mode when it is turned off. The panel PC can be easily turned on via network or a power switch in standby mode. Remote power control is perfect for advertising applications since the broadcasting

ITG-100-AL Embedded System

time for each panel PC can be set individually and controlled remotely. Other possible application includes:

- Security surveillance
- Point-of-Sale (POS)
- Advertising terminal

3.9 Reset the System

The reset button enables user to reboot the system when the system is turned on. To reboot the system, follow the steps below.

Step 1: Locate the reset button on the front panel (**Figure 3-16**).

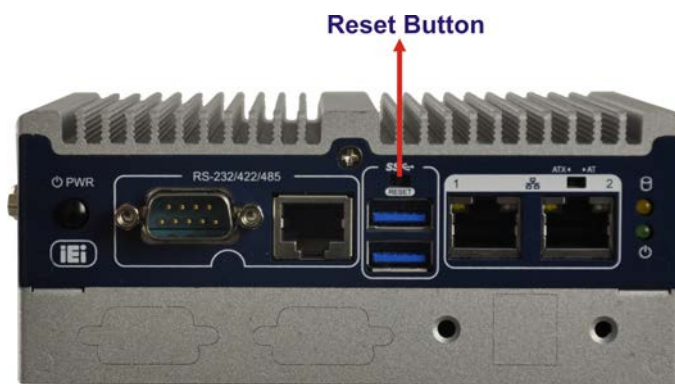

Figure 3-16: Reset Button Location

Step 2: Press the reset button.

3.10 Powering On/Off the System

- **Power on** the system: press the power button for 3 seconds
- **Power off** the system: press the power button for 6 seconds

Power button



Figure 3-17: Power Button Location

3.11 Mounting the System

3.11.1 Mounting the System with DIN Rail Mounting Kit

To mount the ITG-100-AL embedded system onto a DIN rail, please follow the steps below.

Step 1: Attach the DIN rail mounting bracket to the rear panel of the embedded system. Secure the bracket to the embedded system with the supplied retention screws (Figure 3-18).

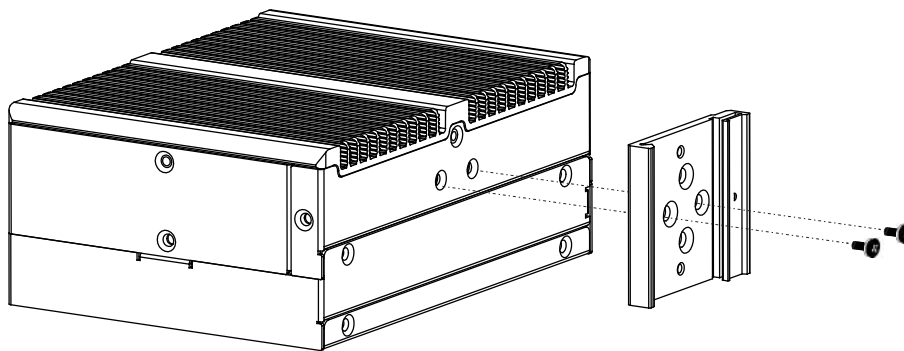

Figure 3-18: Mounting the DIN Rail

Step 2: Place the track against the back of the DIN rail mounting bracket making sure the edges of the track are between the clamps of the DIN rail mounting bracket (Figure 3-19).

ITG-100-AL Embedded System

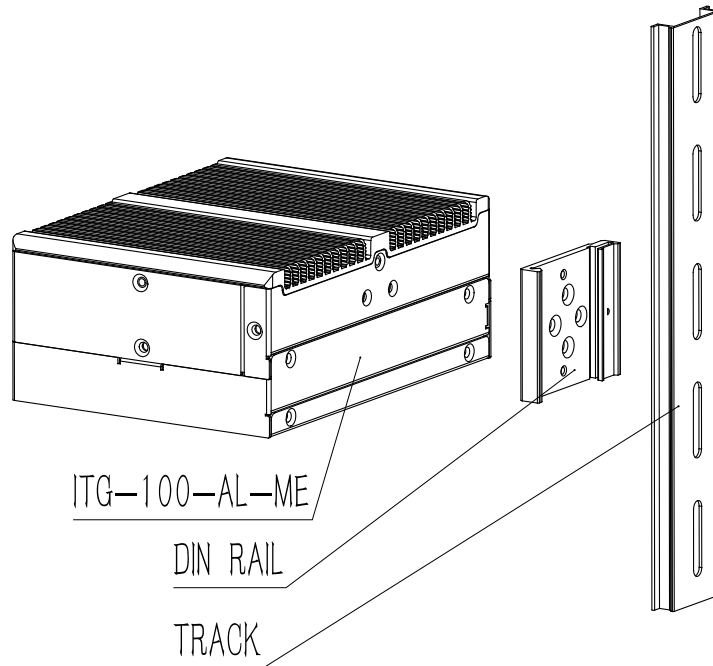

Figure 3-19: Mounting the Track to the DIN Rail

3.12 RS-232/422/485 Serial Port Connection

The ITG-100-AL has two RS-232/422/485 serial port connectors on the bottom panel. One is DB-9 connector and the other is RJ-45 connector.

3.12.1 DB-9 RS-232/422/485 Serial Port Connection

DB-9 RS-232/422/485 serial port devices can be attached to the DB-9 port on the bottom panel.

- Step 1:** Locate the DB-9 connector. The locations of the DB-9 connector are shown in Figure 1-3.
- Step 2:** Insert the serial connector. Insert the DB-9 connector of a serial device into the DB-9 connector on the external peripheral interface. See Figure 3-20.

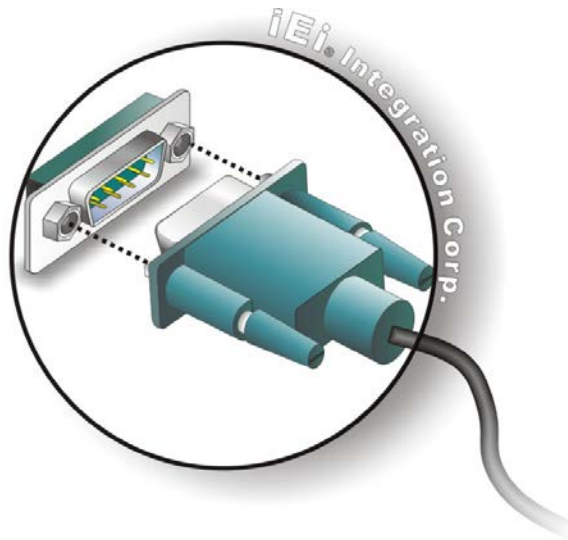

Figure 3-20: Serial Device Connector

Step 3: Secure the connector. Secure the serial device connector to the external interface by tightening the two retention screws on either side of the connector.

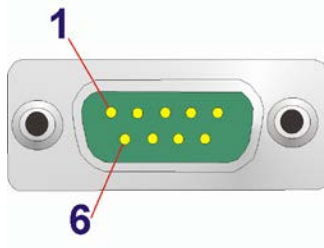

Figure 3-21: DB-9 RS-232/422/485 Serial Port Connector

3.12.2 RJ-45 RS-232/422/485 Serial Port Connection

The RJ-45 RS-232/422/485 serial port connects to a cable with a standard DB-9 connector at the other end (cables included). Follow the steps below to connect a serial device to the ITG-100-AL.

Step 1: Locate the RJ-45 connector. The location of the RJ-45 serial port connector is shown in **Chapter 2**. The RJ-45 connectors for the serial ports can be identified easily as the RJ-45 for the network has two LEDs on the port, while the connectors for the serial cables don't.

ITG-100-AL Embedded System

Step 2: Insert the RJ-45 to DB-9 cable.

Step 3: Insert the serial connector. Insert the DB-9 connector of a serial device into the DB-9 connector on the cable. See **Figure 3-22**.

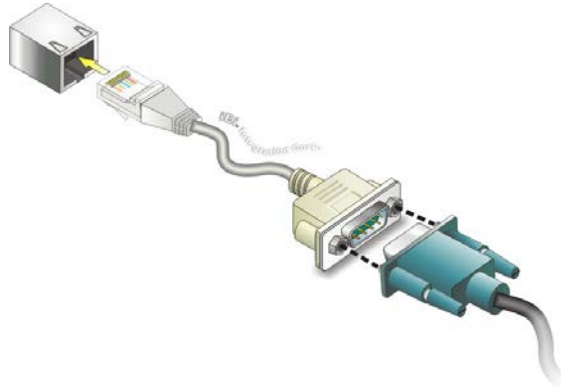

Figure 3-22: Serial Device Connector

Step 4: Secure the connector. Secure the serial device connector to the external interface by tightening the two retention screws on either side of the connector.

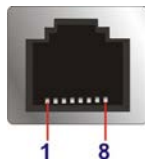

Figure 3-23: RJ-45 RS-232/422/485 Serial Port Connector

Pin	RS-232	RS-422	RS-485
1	NDCD1	TX-	DATA-
2	NDSR1		
3	NRX1	TX+	DATA+
4	NRTS1		
5	NTX1	RX+	
6	NCTS1		
7	NDTR1	RX-	
8	NRI1		

Table 3-1: RJ-45 RS-232/422/485 Serial Port Pinouts

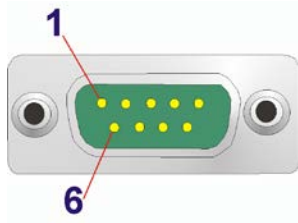

Figure 3-24: DB-9 RS-232/422/485 Connector Pinout Location

Pin	RS-232	RS-422	RS-485
1	ND CD	TX-	DATA-
2	NRX	TX+	DATA+
3	NTX	RX+	
4	NDTR	RX-	
5	GND		
6	NDSR		
7	NRTS		
8	NCTS		
9	NRI		

Table 3-2: DB-9 RS-232/422/485 Connector Pinouts



NOTE:

The communication protocol of the serial ports is set through the BIOS menu in “Advanced → F81866 Super IO Configuration → Serial Port 1/2 Configuration”. Use the **Device Mode** BIOS option to configure the correspondent serial ports (refer to **Sections 5.3.2.1.1** and **5.3.2.1.2** for detailed information).

Chapter

4

System Motherboard

4.1 Overview

This chapter details all the jumpers and connectors of the system motherboard.

4.1.1 Layout

The figures below show all the connectors and jumpers of the system motherboard. The Pin 1 locations of the on-board connectors are also indicated in the diagram below.

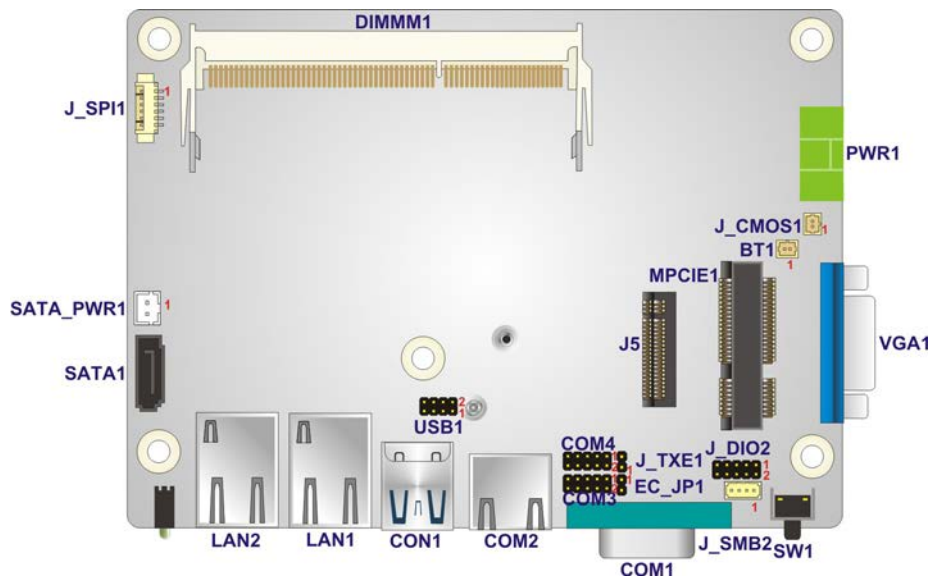

Figure 4-1: System Motherboard (Front)

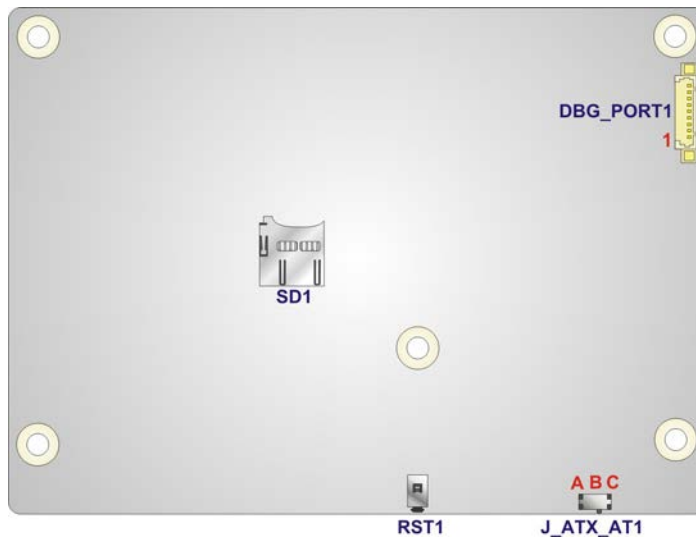

Figure 4-2: System Motherboard (Rear)

ITG-100-AL Embedded System

4.2 Internal Peripheral Connectors

The table below shows a list of the internal peripheral interface connectors on the system motherboard. Pinouts of these connectors can be found in the following sections.

Connector	Type	Label
Battery connector	2-pin wafer	BT1
BIOS programming connector	6-pin wafer	J_SPI1
Debug connector	9-pin wafer	DBG_PORT1
DIO connector	10-pin header	J_DIO2
EC ROM Flash connector	2-pin header	EC_JP1
RS-232 serial port connectors	10-pin header	COM3, COM4
SMBUS/I2Cconnector	4-pin wafer	J_SMB2
SATA 6Gb/s drive connectors	7-pin SATA connector	SATA1
SATA power connector	2-pin wafer	SATA_PWR1
Micro SD connector	microSD slot	SD

Table 4-1: Peripheral Interface Connectors

4.2.1 Battery Connector (BT1)

PIN NO.	DESCRIPTION
1	VBATT
2	GND

Table 4-2: Battery Connector Pinouts (BAT1)

4.2.2 BIOS Programming Connector (J_SPI1)

PIN NO.	DESCRIPTION	PIN NO.	DESCRIPTION
1	+1.8V_SPI	2	SPI_CS#0 -
3	SPI_SO	4	SPI_CLK
5	SPI_SI+	6	GND

Table 4-3: BIOS Programming Connector Pinouts (J_SPI1)

4.2.3 Debug Connector (DBG_PORT1)

PIN NO.	DESCRIPTION	PIN NO.	DESCRIPTION
1	BUF_PLT_RST#	2	LPC_TPM
3	GND	4	LPC_AD3
5	LPC_AD2	6	LPC_AD1
7	LPC_ADO	8	LPC_FRAME_N
9	V3P3_S		

Table 4-4: Debug Connector Pinouts (DBG_PORT1)

4.2.4 DIO Connector (J_DIO2)

PIN NO.	DESCRIPTION	PIN NO.	DESCRIPTION
1	GND	2	V5_S
3	DOUT3	4	DOUT2
5	DOUT1	6	DOUT0
7	DIN3	8	DIN2
9	DIN1	10	DIN0

Table 4-5: DIO Connector Pinouts (J_DIO2)

4.2.5 EC ROM Flash Connector (EC_JP1)

PIN NO.	DESCRIPTION	PIN NO.	DESCRIPTION
1	SMB_CLK_FW	2	SMB_DATA_FW

Table 4-6: EC ROM Flash Connector Pinouts (EC_JP1)

4.2.6 RS-232 Serial Port Connector (COM3)

PIN NO.	DESCRIPTION	PIN NO.	DESCRIPTION
1	NDCD3	2	NDSR3
3	NRX3	4	NRTS3
5	NTX3	6	NCTS3
7	NDTR3	8	NRI3
9	GND	10	GND

ITG-100-AL Embedded System

Table 4-7: RS-232 Serial Port Connector Pinouts (COM3)

4.2.7 RS-232 Serial Port Connector (COM4)

PIN NO.	DESCRIPTION	PIN NO.	DESCRIPTION
1	NDCD4	2	NDSR4
3	NRX4	4	NRTS4
5	NTX4	6	NCTS4
7	NDTR4	8	NRI4
9	GND	10	GND

Table 4-8: RS-232 Serial Port Connector Pinouts (COM4)

4.2.8 SMBUS/I2C Connector (J_SMB2)

PIN NO.	DESCRIPTION	PIN NO.	DESCRIPTION
1	GND	2	DATA
3	CLK	4	V5_S

Table 4-9: SMBUS/I2C Connector Pinouts (J_SMB2)

4.2.9 SATA 6Gb/s Drive Connectors (SATA1)

PIN NO.	DESCRIPTION	PIN NO.	DESCRIPTION
1	GND	2	SATA_TXP0
3	SATA_TXN0	4	GND
5	SATA_RXN0	6	SATA_RXP0
7	GND		

Table 4-10: SATA 6Gb/s Drive Connectors Pinouts (SATA1)

4.2.10 SATA Power Connector (SATA_PWR1)

PIN NO.	DESCRIPTION	PIN NO.	DESCRIPTION
1	+5V	2	GND

Table 4-11: SATA Power Connector Pinouts (SATA_PWR1)

4.2.11 Micro SD Connector (SD1)

PIN NO.	DESCRIPTION	PIN NO.	DESCRIPTION
1	SD_D2	5	SD_CLK
2	SD_D3	6	GND
3	SD_CMD	7	SD_D0
4	SD_V3P3	8	SD_D1
G1	VCC	G3	SD_CD#
G2	VCC	G4	GND

Table 4-12: Micro SD Connector Pinouts (SD1)

4.3 External Interface Panel Connectors

The table below shows a list of the external interface panel connectors on the system motherboard. Pinouts of these connectors can be found in the following sections.

Connector	Type	Label
Ethernet connectors	RJ-45	LAN1, LAN2
Power button	Button	SW1
DC-IN connector	Terminal block	PWR1
RS-232/422/485 serial port connector	DB-9	COM1
RS-232/422/485 serial port connector	RJ-45	COM2
USB 3.0 connectors	USB 3.0 port	CON1
VGA connector	DB-15	VGA1

Table 4-13: Rear Panel Connectors

4.3.1 Ethernet Connector (LAN1)

PIN NO.	DESCRIPTION	PIN NO.	DESCRIPTION
R1	TRD2P0	R2	TRD2N0
R3	TRD2P1	R4	TRD2N1
R5	1_5VLAN1	R6	1_5VLAN1
R7	TRD2P2	R8	TRD2N2

ITG-100-AL Embedded System

R9	TRD2P3	R10	TRD2N3
G1	LAN1_GND	G2	LAN1_GND
L1	+V3.3LAN1	L2	L1_LINK_ACT-
L3	L1_100-	L4	L1_1000-

Table 4-14: Ethernet Connector Pinouts (LAN1)

4.3.2 Ethernet Connector (LAN2)

PIN NO.	DESCRIPTION	PIN NO.	DESCRIPTION
R1	2TRD2P0	R2	2TRD2N0
R3	2TRD2P1	R4	2TRD2N1
R5	1_5VLAN2	R6	1_5VLAN2
R7	2TRD2P2	R8	2TRD2N2
R9	2TRD2P3	R10	2TRD2N3
G1	LAN2_GND	G2	LAN2_GND
L1	+V3.3LAN2	L2	L2_LINK_ACT-
L3	L2_100-	L4	L2_1000-

Table 4-15: Ethernet Connector Pinouts (LAN2)

4.3.3 Power Button (SW1)

PIN NO.	DESCRIPTION	PIN NO.	DESCRIPTION
1	NC	2	PWRBTN_SW#
3	GND	4	NC
5	NC	6	GND
L1	V3P3_S	L2	GND
G1	NC	G2	NC

Table 4-16: Power Button Pinouts (SW1)

4.3.4 DC-IN Connector (PWR1)

PIN NO.	DESCRIPTION	PIN NO.	DESCRIPTION
1	DC_IN	2	GND

Table 4-17: DC-IN Connector Pinouts (PWR1)

4.3.5 RS-232/422/485 Connector (COM1)

PIN NO.	DESCRIPTION	PIN NO.	DESCRIPTION
1	NDCD1	6	NDSR1
2	NRX1	7	NRTS1
3	NTX1	8	NCTS1
4	NDTR1	9	NRI1
5	GND		

Table 4-18: RS-232/422/485 Connector (COM1)

4.3.6 RJ45 to RS-232/422/485 Connector (COM2)

PIN NO.	DESCRIPTION	PIN NO.	DESCRIPTION
1	NRI2	6	NRX2
2	NDTR2	7	NDSR2
3	NCTS2	8	NDCD2
4	NTX2	G1	GND
5	NRTS2	G2	GND

Table 4-19: RS-232/422/485 Connector (COM2)

4.3.7 USB 3.0 Connectors (CON1)

PIN NO.	DESCRIPTION	PIN NO.	DESCRIPTION
1	VCC_USB_1_2	10	VCC_USB_1_2
2	-DATA0	11	-DATA1
3	+DATA0	12	+DATA1
4	GND	13	GND
5	USB3P0_RXDN1	14	USB3P0_RXDN2
6	USB3P0_RXDP1	15	USB3P0_RXDP2
7	GND	16	GND
8	USB3P0_TXDN1	17	USB3P0_TXDN2
9	USB3P0_TXDP1	18	USB3P0_TXDP2
G1	USB3_GND	G3	USB3_GND
G2	USB3_GND	G4	USB3_GND

ITG-100-AL Embedded System

Table 4-20: USB 3.0 Connectors Pinouts (CON1)

4.3.8 VGA Connector (VGA1)

PIN NO.	DESCRIPTION	PIN NO.	DESCRIPTION
1	BR	2	BG
3	BB	4	NC
5	GND	6	GND
7	GND	8	GND
9	CRT_VCC	10	CRT_PLUG#
11	NC	12	5VDDCDA
13	5HSYNC	14	5VSYNC
15	5VDDCLK		

Table 4-21: VGA Connector Pinouts (VGA1)

4.4 Jumper Settings

The buttons, jumper and switch on the system motherboard are listed in **Table 4-22**.

Connector	Type	Label
AT/ATX Mode select switch	switch	J_ATX_AT1
Clear CMOS button	button	J_CMOS1
System reset button	button	RST1
Flash Descriptor Security Override Jumper	2-pin header	J_TXE1

Table 4-22: Buttons, Jumper and Switch

4.4.1 AT/ATX Mode Select Switch (J_ATX_AT1)

Setting	Description
Short A-B	ATX Mode (Default)
Short B-C	AT Mode

Table 4-23: AT/ATX Mode Select Switch (J_ATX_AT1)

4.4.2 Clear CMOS Button (J_CMOS1)

Setting	Description
Open	Normal Operation (Default)
Push	Clear CMOS Setup

Table 4-24: Clear CMOS Button (J_CMOS1)

4.4.3 System Reset Button (RST1)

Setting	Description
Open	Normal Operation (Default)
Push	System Restart

Table 4-25: System Reset Button (RST1)

4.4.4 Flash Descriptor Security Override Jumper Settings (J_TXE1)

Setting	Description
Open	No override (Default)
Short	Override

Table 4-26: Flash Descriptor Security Override Jumper Settings (J_TXE1)

Chapter

5

BIOS

5.1 Introduction

The BIOS is programmed onto the BIOS chip. The BIOS setup program allows changes to certain system settings. This chapter outlines the options that can be changed.



NOTE:

Some of the BIOS options may vary throughout the life cycle of the product and are subject to change without prior notice.

5.1.1 Starting Setup

The UEFI BIOS is activated when the computer is turned on. The setup program can be activated in one of two ways.

1. Press the **DELETE** or **F2** key as soon as the system is turned on or
2. Press the **DELETE** or **F2** key when the “**Press Del to enter SETUP**” message appears on the screen.

If the message disappears before the **DELETE** or **F2** key is pressed, restart the computer and try again.

5.1.2 Using Setup

Use the arrow keys to highlight items, press **ENTER** to select, use the PageUp and PageDown keys to change entries, press **F1** for help and press **ESC** to quit. Navigation keys are shown in.

Key	Function
Up arrow	Move to previous item
Down arrow	Move to next item
Left arrow	Move to the item on the left hand side
Right arrow	Move to the item on the right hand side
+	Increase the numeric value or make changes

ITG-100-AL Embedded System

Key	Function
-	Decrease the numeric value or make changes
F1 key	General help, only for Status Page Setup Menu and Option Page Setup Menu
F2 key	Load previous values.
F3 key	Load optimized defaults
F4 key	Save changes and Exit BIOS
Esc key	Main Menu – Quit and not save changes into CMOS Status Page Setup Menu and Option Page Setup Menu -- Exit current page and return to Main Menu

Table 5-1: BIOS Navigation Keys

5.1.3 Getting Help

When **F1** is pressed a small help window describing the appropriate keys to use and the possible selections for the highlighted item appears. To exit the Help Window press **Esc** or the **F1** key again.

5.1.4 Unable to Reboot after Configuration Changes

If the computer cannot boot after changes to the system configuration is made, CMOS defaults. Use the jumper described in Chapter 3.

5.1.5 BIOS Menu Bar

The **menu bar** on top of the BIOS screen has the following main items:

- Main – Changes the basic system configuration.
- Advanced – Changes the advanced system settings.
- Chipset – Changes the chipset settings.
- Security – Sets User and Supervisor Passwords.
- Boot – Changes the system boot configuration.
- Save & Exit – Selects exit options and loads default settings

The following sections completely describe the configuration options found in the menu items at the top of the BIOS screen and listed above.

5.2 Main

The **Main** BIOS menu (**BIOS Menu 1**) appears when the **BIOS Setup** program is entered.

The **Main** menu gives an overview of the basic system information.

Aptio Setup Utility - Copyright (C) 2018 American Megatrends, Inc.					
Main	Advanced	Chipset	Security	Boot	Save & Exit
BIOS Information					Set the Date. Use Tab to switch between Data elements.
BIOS Vendor			American Megatrends		Default Ranges:
Core Version			5.12		Year: 2005-2099
Compliancy			UEFI 2.5; PI 1.4		Months: 1-12
Project Version			SE27AR11.BIN		Days: dependent on month
Build Date and Time			10/25/2018 14:22:53		
iWDD Vendor			iEi		
iWDD Version			SE27ER10.bin		
Platform firmware Information					
BXT SOC			B1		
MRC Version			0.56		
PUNIT FW			2E		
PMC FW			03.29		
TXE FW			3.1.50.2222		
ISH FW			4.1.0.3364		
GOP			0.0.0036		
CPU Flavor			BXT Notebook/Desktop...		
Board ID			Oxbow Hill CRB (06)		
Fab ID			FAB A		
Memory Information					
Total Memory			2048 MB		
Memory Speed			1600 MHz		
System Date			[Fri 11/02/2018]		
System Time			[19:43:27]		
Access Level			Administrator		
Version 2.18.1263. Copyright (C) 2018 American Megatrends, Inc.					

BIOS Menu 1: Main

The System Overview field also has two user configurable fields:

ITG-100-AL Embedded System

→ System Date [xx/xx/xx]

Use the **System Date** option to set the system date. Manually enter the day, month and year.

→ System Time [xx:xx:xx]

Use the **System Time** option to set the system time. Manually enter the hours, minutes and seconds.

5.3 Advanced

Use the **Advanced** menu (**BIOS Menu 2**) to configure the CPU and peripheral devices through the following sub-menus:



WARNING!

Setting the wrong values in the sections below may cause the system to malfunction. Make sure that the settings made are compatible with the hardware.

```

Aptio Setup Utility - Copyright (C) 2018 American Megatrends, Inc.
Main  Advanced  Chipset  Security  Boot  Save & Exit
-----
> ACPI Settings
> F81866 Super IO Configuration
> Hardware Monitor
> RTC Wake Settings
> Serial Port Console Redirection
> CPU Configuration
> USB Configuration
> iEi Feature
> SATA Configuration

System ACPI Parameters.
-----
<=>: Select Screen
↑ ↓: Select Item
Enter>Select
F1  General Help
F2  Previous Values
F3  Optimized Defaults
F4  Save
ESC Exit

Version 2.18.1263. Copyright (C) 2018 American Megatrends, Inc.
    
```

BIOS Menu 2: Advanced

5.3.1 ACPI Settings

The **ACPI Settings** menu (**BIOS Menu 3**) configures the Advanced Configuration and Power Interface (ACPI) options.

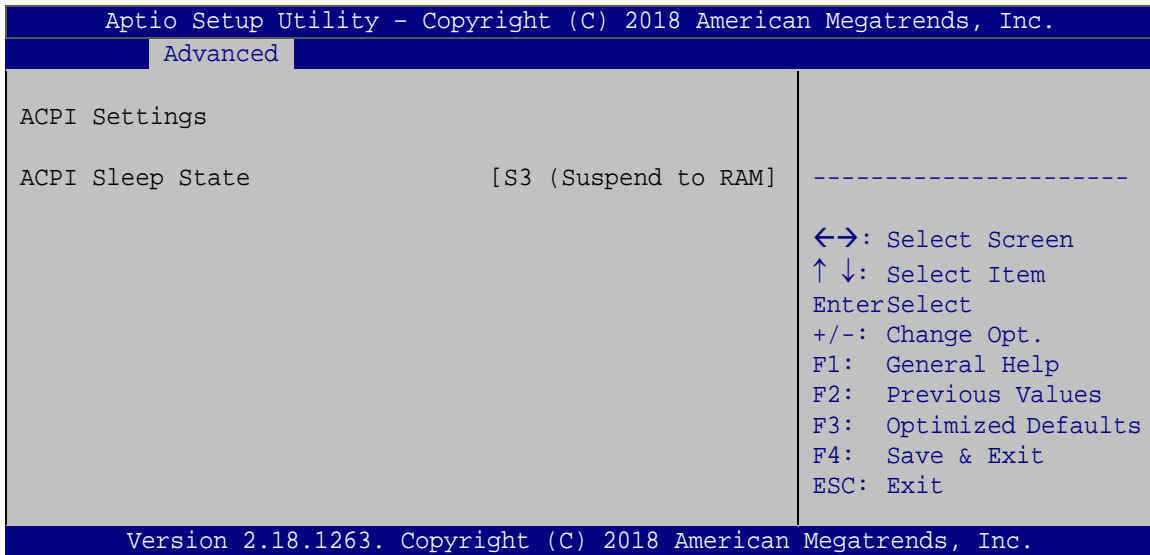

BIOS Menu 3: ACPI Configuration

→ **ACPI Sleep State [S3 only (Suspend to RAM)]**

The fields in **ACPI Sleep State** option cannot be changed.

- **Suspend Disabled** Disable the suspend function.
- **S3 (Suspend to DEFAULT RAM)** The caches are flushed and the CPU is powered off. Power to the RAM is maintained. The computer returns slower to a working state, but more power is saved.

ITG-100-AL Embedded System

5.3.2 F81866 Super IO Configuration

Use the **F81866 Super IO Configuration** menu (**BIOS Menu 10**) to set or change the configurations for the serial ports.

```

Aptio Setup Utility - Copyright (C) 2018 American Megatrends, Inc.
  Advanced
F81866 Super IO Configuration
Super IO Chip                      F81866
> Serial Port 1 Configuration
> Serial Port 2 Configuration
> Serial Port 3 Configuration
> Serial Port 4 Configuration
Set Parameters of Serial Port 1 (COMA)
-----
<=>: Select Screen
↑ ↓: Select Item
EnterSelect
F1  General Help
F2  Previous Values
F3  Optimized
Defaults
F4  Save
ESC Exit
Version 2.18.1263. Copyright (C) 2018 American Megatrends, Inc.
  
```

BIOS Menu 4: Super IO Configuration

5.3.2.1 Serial Port n Configuration

Use the **Serial Port n Configuration** menu (**BIOS Menu 5**) to configure the serial port n.

```

Aptio Setup Utility - Copyright (C) 2018 American Megatrends, Inc.
  Advanced
Serial Port 1 Configuration
Serial Port                      [Enabled]
Device Settings                  IO=3F8h; IRQ=4
Device Mode                      [RS232]
Enable or Disable Serial Port (COM)
-----
<=>: Select Screen
↑ ↓: Select Item
EnterSelect
F1  General Help
F2  Previous Values
F3  Optimized
Defaults
F4  Save
ESC Exit
Version 2.18.1263. Copyright (C) 2018 American Megatrends, Inc.
  
```

BIOS Menu 5: Serial Port 1 Configuration Menu

5.3.2.1.1 Serial Port 1 Configuration

→ Serial Port [Enabled]

Use the **Serial Port** option to enable or disable the serial port.

- **Disabled** Disable the serial port
- **Enabled** **DEFAULT** Enable the serial port

→ Device Mode [RS232]

Use the **Device Mode** option to select the serial port mode.

- **RS232** **DEFAULT** Enables serial port RS-232 support.
- **RS422** Enables serial port RS-422 support.
- **RS485** Enables serial port RS-485 support.

5.3.2.1.2 Serial Port 2 Configuration

→ Serial Port [Enabled]

Use the **Serial Port** option to enable or disable the serial port.

- **Disabled** Disable the serial port
- **Enabled** **DEFAULT** Enable the serial port

→ Device Mode [RS232]

Use the **Device Mode** option to select the serial port mode.

- **RS232** **DEFAULT** Enables serial port RS-232 support.
- **RS422** Enables serial port RS-422 support.
- **RS485** Enables serial port RS-485 support.

ITG-100-AL Embedded System

5.3.2.1.3 Serial Port 3 Configuration

→ Serial Port [Enabled]

Use the **Serial Port** option to enable or disable the serial port.

- **Disabled** Disable the serial port
- **Enabled** **DEFAULT** Enable the serial port

5.3.2.1.4 Serial Port 4 Configuration

→ Serial Port [Enabled]

Use the **Serial Port** option to enable or disable the serial port.

- **Disabled** Disable the serial port
- **Enabled** **DEFAULT** Enable the serial port

5.3.3 Hardware Monitor

The Hardware Monitor menu (**BIOS Menu 6**) contains the fan configuration submenus and displays operating temperature, fan speeds and system voltages.

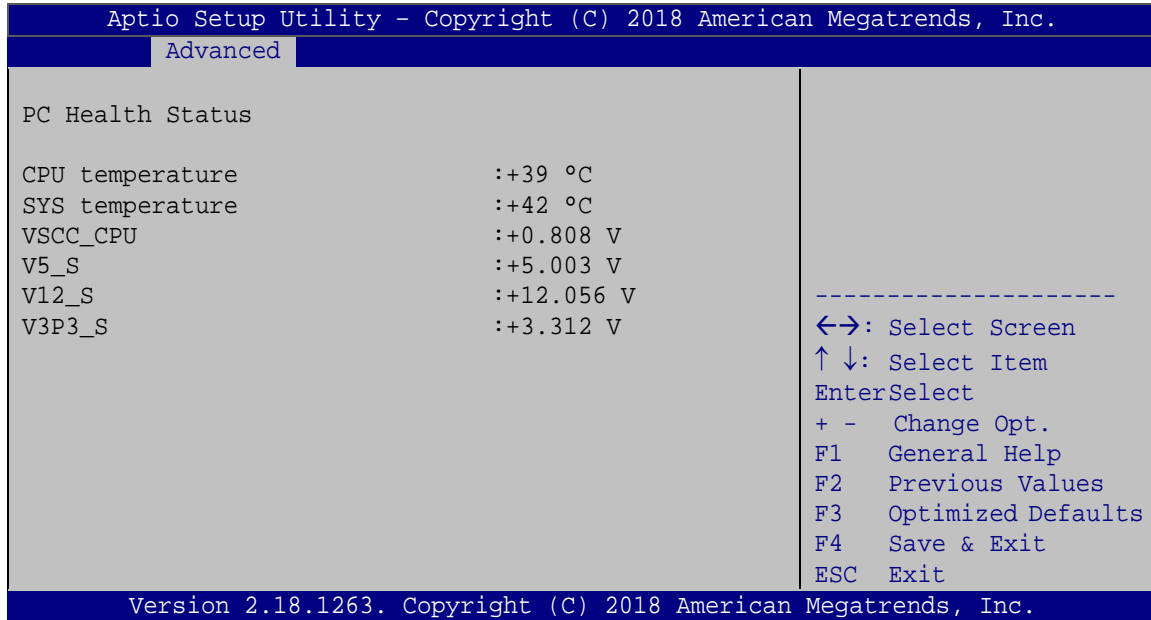

BIOS Menu 6: Hardware Monitor

→ PC Health Status

The following system parameters and values are shown. The system parameters that are monitored are:

- Temperatures:
 - CPU Temperature
 - System temperature
- Voltages:
 - VSCC_CPU
 - V5_S
 - V12_S
 - V3P3_S

5.3.4 RTC Wake Settings

The **RTC Wake Settings** menu (**BIOS Menu 8**) configures RTC wake event.

ITG-100-AL Embedded System

```

Aptio Setup Utility - Copyright (C) 2018 American Megatrends, Inc.
Advanced
RTC Wake Settings
Wake system with Fixed Time [Disabled]
-----
-
<=>: Select Screen
↑↓: Select Item
Enter>Select
F1  General Help
F2  Previous Values
F3  Optimized
Defaults
F4  Save
ESC Exit
Version 2.18.1263. Copyright (C) 2018 American Megatrends, Inc.

```

BIOS Menu 7: RTC Wake Settings

→ Wake system with Fixed Time [Disabled]

Use the **Wake system with Fixed Time** option to enable or disable the system wake on alarm event.

→ **Disabled** **DEFAULT** The real time clock (RTC) cannot generate a wake event

→ **Enabled** If selected, the **Wake up every day** option appears allowing you to enable to disable the system to wake every day at the specified time. Besides, the following options appear with values that can be selected:

Wake up date

Wake up hour

Wake up minute

Wake up second

After setting the alarm, the computer turns itself on from a suspend state when the alarm goes off.

5.3.5 Serial Port Console Redirection

The **Serial Port Console Redirection** menu (**BIOS Menu 8**) allows the console redirection options to be configured. Console redirection allows users to maintain a system remotely by re-directing keyboard input and text output through the serial port.

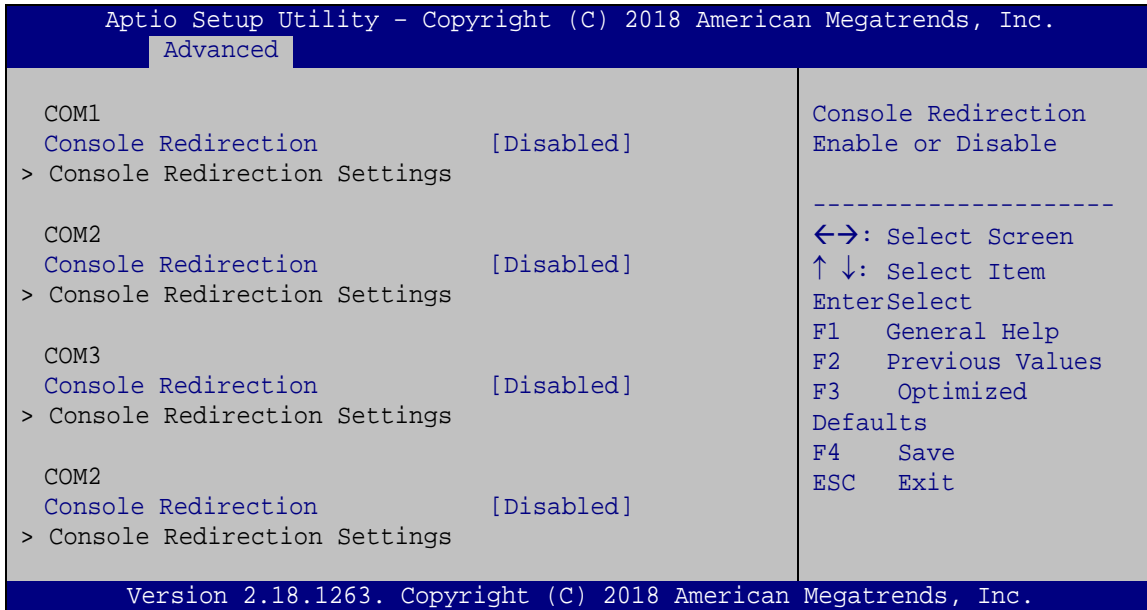

BIOS Menu 8: Serial Port Console Redirection

➔ Console Redirection [Disabled]

Use **Console Redirection** option to enable or disable the console redirection function.

- ➔ **Disabled** **DEFAULT** Disabled the console redirection function
- ➔ **Enabled** Enabled the console redirection function

5.3.5.1 Console Redirection Settings

The **Console Redirection Settings** menu (**BIOS Menu 9**) allows the console redirection options to be configured. The option is active when Console Redirection option is enabled.

ITG-100-AL Embedded System

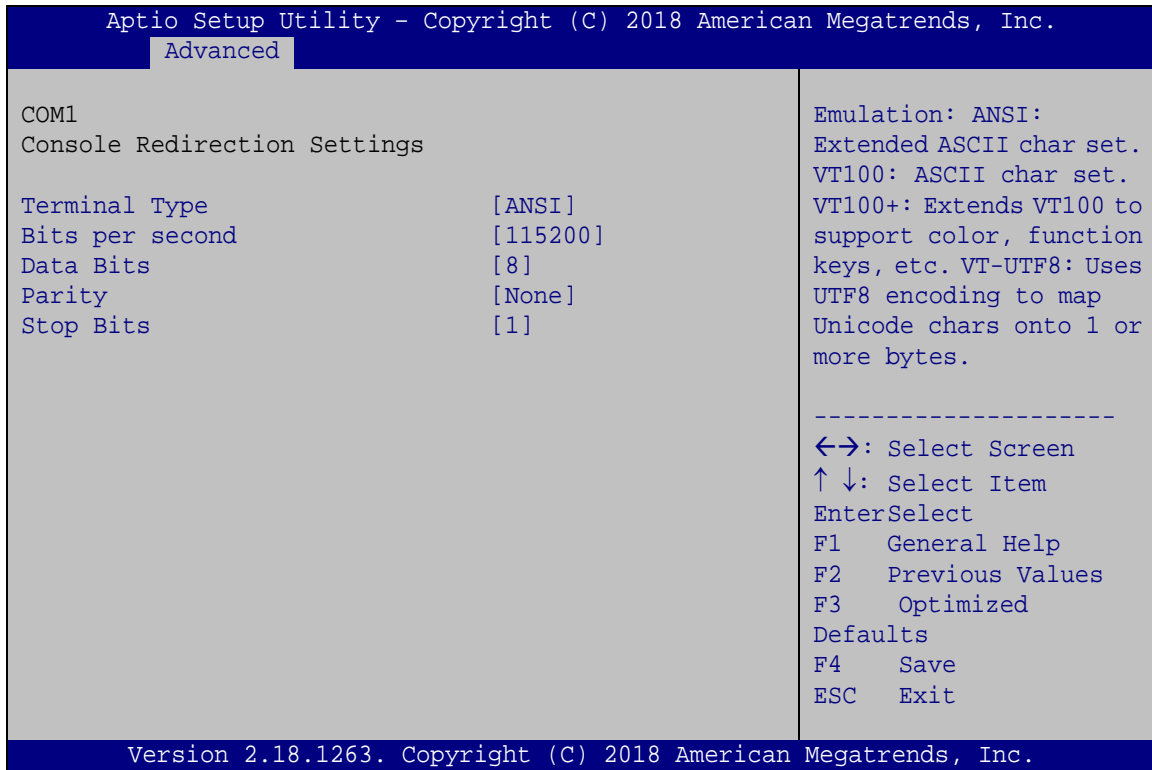

BIOS Menu 9: Console Redirection Settings

→ Terminal Type [ANSI]

Use the **Terminal Type** option to specify the remote terminal type.

- **VT100** The target terminal type is VT100
- **VT100+** The target terminal type is VT100+
- **VT-UTF8** The target terminal type is VT-UTF8
- **ANSI** **DEFAULT** The target terminal type is ANSI

→ Bits per second [115200]

Use the **Bits per second** option to specify the serial port transmission speed. The speed must match the other side. Long or noisy lines may require lower speeds.

- **9600** Sets the serial port transmission speed at 9600.
- **19200** Sets the serial port transmission speed at 19200.

- **38400** Sets the serial port transmission speed at 38400.
- **57600** Sets the serial port transmission speed at 57600.
- **115200** **DEFAULT** Sets the serial port transmission speed at 115200.

→ Data Bits [8]

Use the **Data Bits** option to specify the number of data bits.

- **7** Sets the data bits at 7.
- **8** **DEFAULT** Sets the data bits at 8.

→ Parity [None]

Use the **Parity** option to specify the parity bit that can be sent with the data bits for detecting the transmission errors.

- **None** **DEFAULT** No parity bit is sent with the data bits.
- **Even** The parity bit is 0 if the number of ones in the data bits is even.
- **Odd** The parity bit is 0 if the number of ones in the data bits is odd.
- **Mark** The parity bit is always 1. This option does not provide error detection.
- **Space** The parity bit is always 0. This option does not provide error detection.

→ Stop Bits [1]

Use the **Stop Bits** option to specify the number of stop bits used to indicate the end of a serial data packet. Communication with slow devices may require more than 1 stop bit.

- **1** **DEFAULT** Sets the number of stop bits at 1.
- **2** Sets the number of stop bits at 2.

ITG-100-AL Embedded System

5.3.6 CPU Configuration

Use the **CPU Configuration** menu (**BIOS Menu 10**) to view detailed CPU specifications and configure the CPU.

```

Aprio Setup Utility - Copyright (C) 2018 American Megatrends, Inc.
  Advanced
CPU Configuration
Intel(R) Atom(TM) Processor E3930 @ 1.30GHz
CPU Signature          506C9
Microcode Patch       2E
Max CPU Speed         1300 MHz
Min CPU Speed         800 MHz
Processor Cores       2
Intel HT Technology   Not Supported
Intel VT-x Technology Supported
Intel SMX Technology  Not Supported

L1 Data Cache        24 KB x 2
L1 Code Cache        32 KB x 2
L2 Cache             1024 KB x 2
L3 Cache             Not Present
Speed                1300 MHz
64-bit               Supported

Intel Virtualization Technology [Disabled]
EIST                  [Enabled]
C-States              [Disabled]

When enabled, a VMM can utilize the additional hardware capabilities provided by Vanderpool Technology.

-----
<->: Select Screen
↑ ↓: Select Item
Enter>Select
F1   General Help
F2   Previous Values
F3   Optimized
Defaults
F4   Save
ESC  Exit

Version 2.18.1263. Copyright (C) 2018 American Megatrends, Inc.
  
```

BIOS Menu 10: CPU Configuration

→ Intel® Virtualization Technology [Disabled]

Use the **Intel® Virtualization Technology** option to enable or disable virtualization on the system. When combined with third party software, Intel Virtualization technology allows several OSs to run on the same system at the same time.

- **Disabled** **DEFAULT** Disables Intel Virtualization Technology.
- **Enabled** Enables Intel Virtualization Technology.

→ EIST [Enabled]

Use the **EIST** option to enable or disable the Intel Speed Step Technology.

- ➔ **Disabled** Disables the Intel Speed Step Technology.
- ➔ **Enabled** **DEFAULT** Enables the Intel Speed Step Technology.

➔ **C-States [Disabled]**

Use the **C-States** option to enable or disable the CPU C state.

- ➔ **Disabled** **DEFAULT** Disables the CPU C state.
- ➔ **Enabled** Enables the CPU C state.

5.3.7 USB Configuration

Use the **USB Configuration** menu (**BIOS Menu 11**) to read USB configuration information and configure the USB settings.

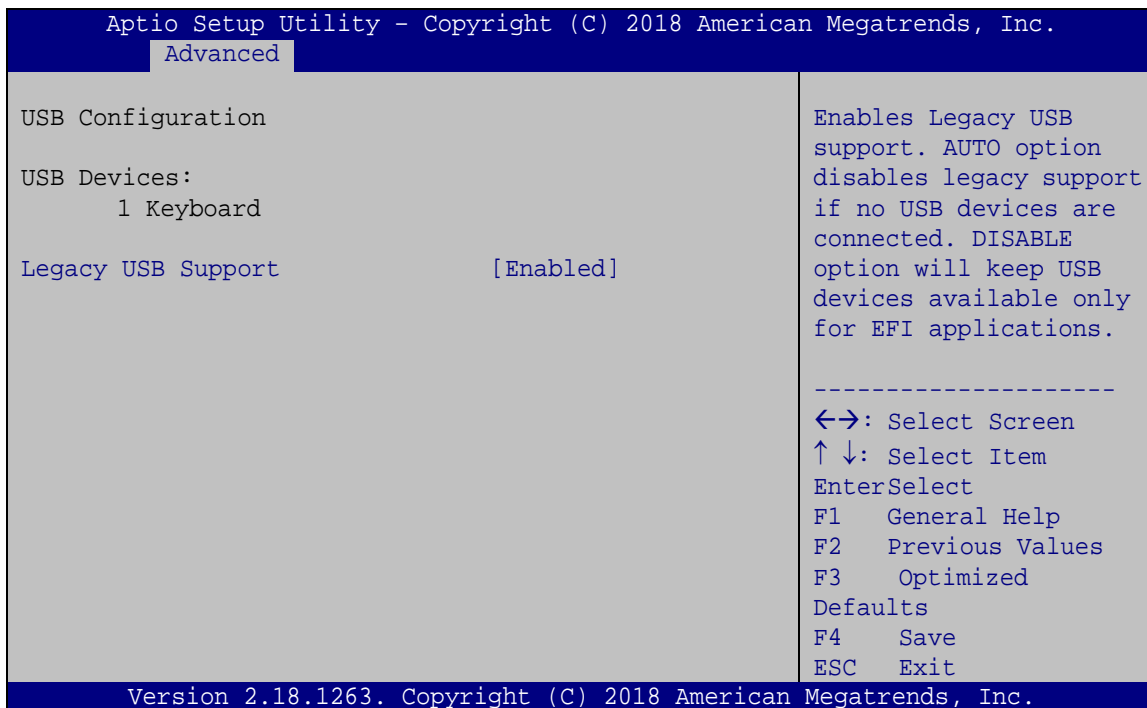

BIOS Menu 11: USB Configuration

➔ **USB Devices**

The **USB Devices Enabled** field lists the USB devices that are enabled on the system

ITG-100-AL Embedded System

➔ Legacy USB Support [Enabled]

Use the **Legacy USB Support** BIOS option to enable USB mouse and USB keyboard support. Normally if this option is not enabled, any attached USB mouse or USB keyboard does not become available until a USB compatible operating system is fully booted with all USB drivers loaded. When this option is enabled, any attached USB mouse or USB keyboard can control the system even when there is no USB driver loaded onto the system.

➔ **Enabled** **DEFAULT** Legacy USB support enabled

➔ **Disabled** Legacy USB support disabled

5.3.8 iEi Feature

Use the **iEi Feature** menu (**BIOS Menu 12**) to configure the iEi features.

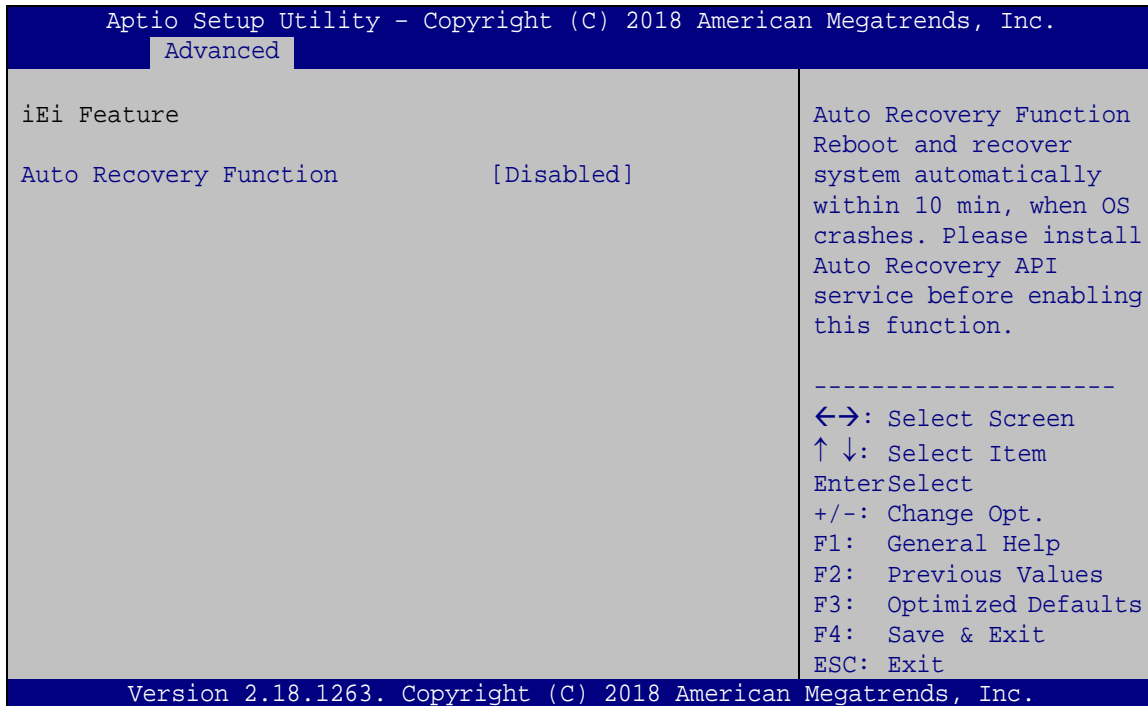

BIOS Menu 12: iEi Feature

➔ Auto Recovery Function [Disabled]

Use **Auto Recovery Function** option to enable or disable the auto recovery function.

- ➔ **Disabled** **DEFAULT** Disabled the auto recovery function
- ➔ **Enabled** Enabled the auto recovery function

5.3.9 SATA Configuration

Use the **SATA Configuration** menu (**BIOS Menu 13**) to change and/or set the configuration of the SATA devices installed in the system.

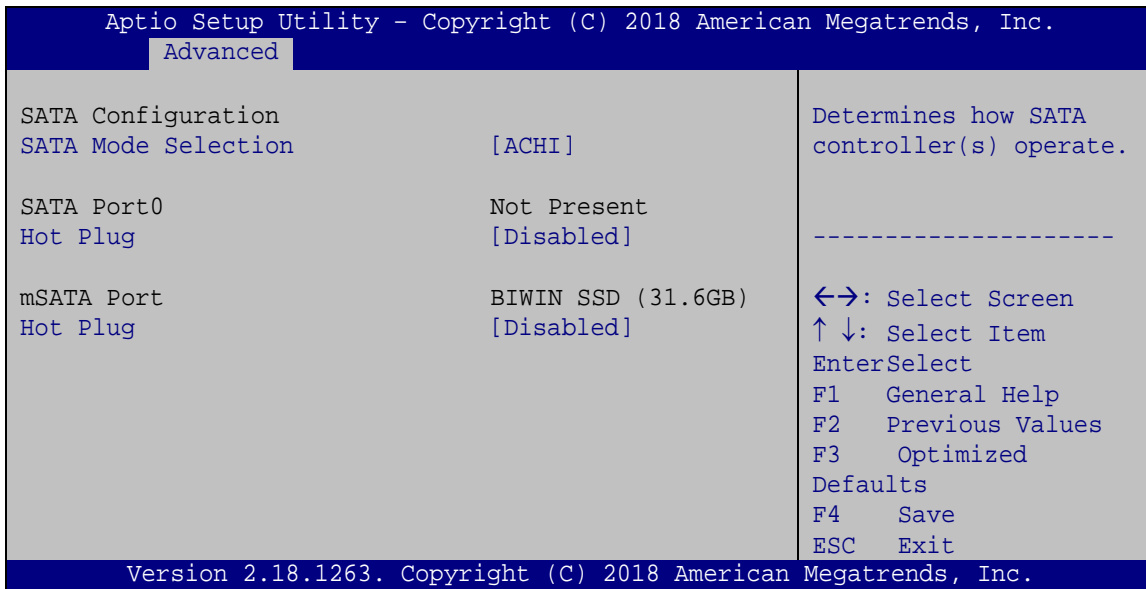

BIOS Menu 13: IDE Configuration

➔ **SATA Mode Selection [ACHI]**

Use the **SATA Mode Selection** option to configure SATA devices as normal IDE devices.

- ➔ **AHCI** **DEFAULT** Configures SATA devices as AHCI device.

➔ **Hot Plug [Disabled]**

Use the **Hot Plug** option to configure the port as Hot Pluggable.

- ➔ **Disabled** **DEFAULT** Disables the port as Hot Pluggable.
- ➔ **Enabled** Enables the port as Hot Pluggable.

ITG-100-AL Embedded System

5.4 Chipset

Use the **Chipset** menu (**BIOS Menu 14**) to access the Northbridge and Southbridge configuration menus



WARNING!

Setting the wrong values for the Chipset BIOS selections in the Chipset BIOS menu may cause the system to malfunction.

```
Aptio Setup Utility - Copyright (C) 2018 American Megatrends, Inc.
Main   Advanced  Chipset  Security  Boot   Save & Exit
-----
> North Bridge
> South Bridge

North Bridge Parameters
-----
<=>: Select Screen
↑↓: Select Item
Enter>Select
+/-: Change Opt.
F1   General Help
F2   Previous Values
F3   Optimized Defaults
F4   Save & Exit
ESC  Exit

Version 2.18.1263. Copyright (C) 2018 American Megatrends, Inc.
```

BIOS Menu 14: Chipset

5.4.1 North Bridge Configuration

Use the **North Bridge Configuration** menu (**BIOS Menu 15**) to configure the Intel IGD settings.

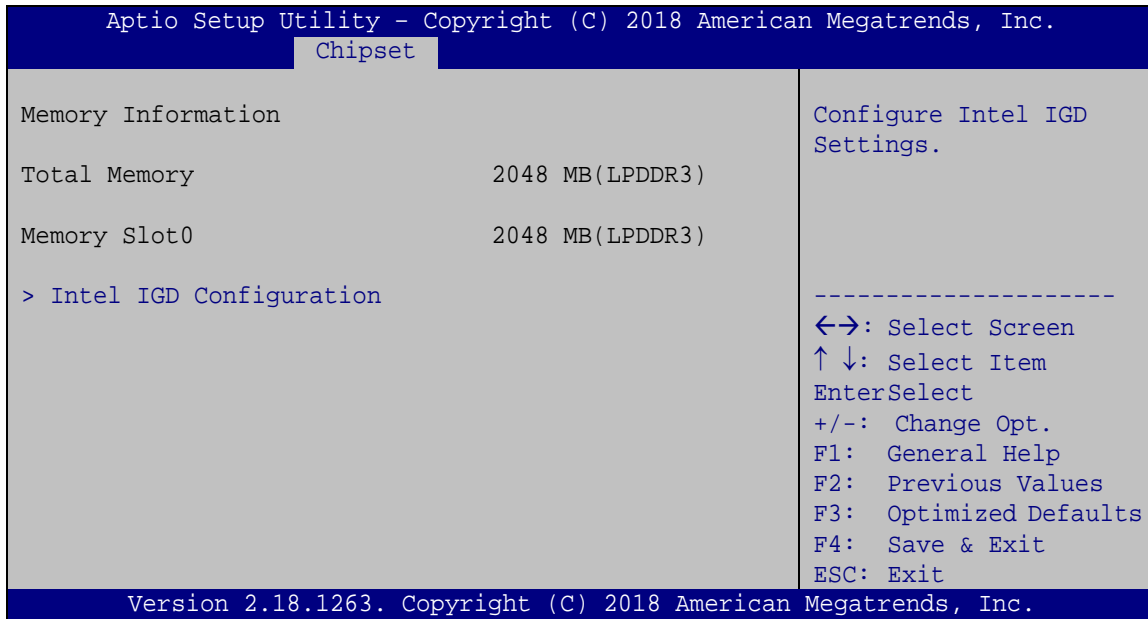

BIOS Menu 15: Northbridge Chipset Configuration

→ Memory Information

The **Memory Information** lists a brief summary of the on-board memory. The fields in **Memory Information** cannot be changed.

5.4.1.1 Intel IGD Configuration

Use the **Intel IGD Configuration** menu (**BIOS Menu 16**) to configure the video device connected to the system.

ITG-100-AL Embedded System

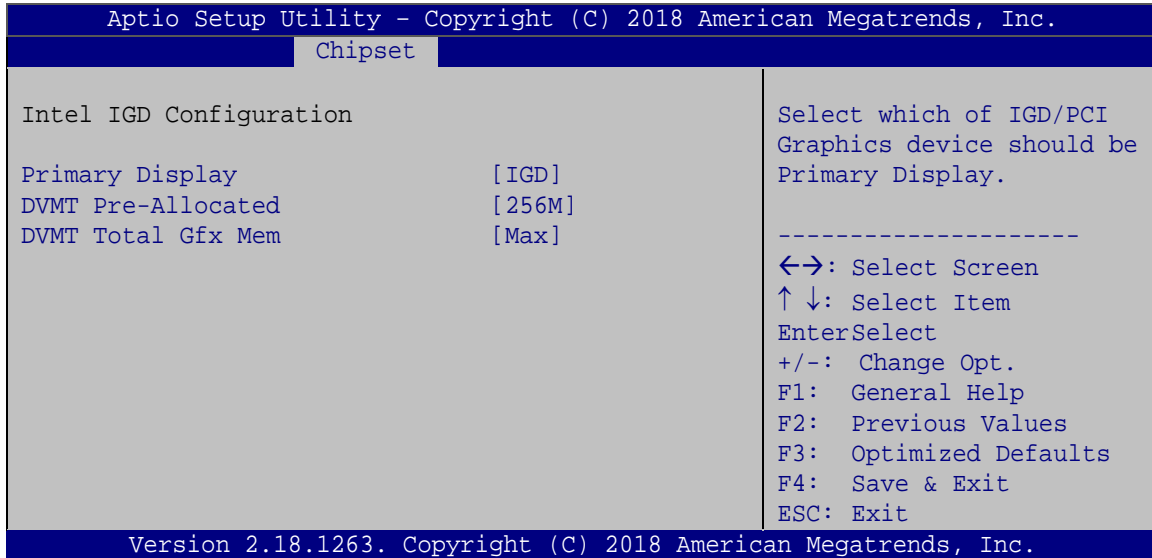

BIOS Menu 16: Integrated Graphics

→ Primary Display [IGD]

Use the **Primary Display** option to select the primary graphics controller the system uses.

The following options are available:

- IGD **Default**
- PCIe

→ DVMT Pre-Allocated [256MB]

Use the **DVMT Pre-Allocated** option to set the amount of system memory allocated to the integrated graphics processor when the system boots. The system memory allocated can then only be used as graphics memory, and is no longer available to applications or the operating system. Configuration options are listed below:

- 64M
- 128M
- 256M **Default**
- 512M

➔ **DVMT Total Gfx Mem [Max]**

Use the **DVMT Total Gfx Mem** option to select DVMT5.0 total graphic memory size used by the internal graphic device. The following options are available:

- 128M
- 256M
- Max **Default**

5.4.2 Southbridge Configuration

Use the **Southbridge Configuration** menu (**BIOS Menu 17**) to configure the Southbridge chipset.

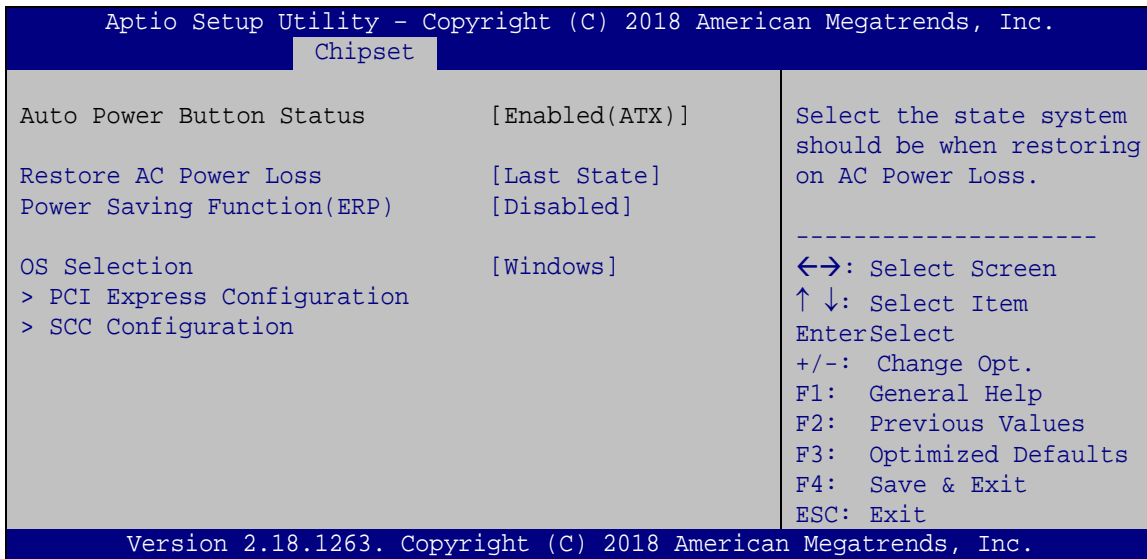

BIOS Menu 17: Southbridge Chipset Configuration

➔ **Restore AC Power Loss [Last State]**

Use the **Restore on AC Power Loss** option to specify what state the system returns to if there is a sudden loss of power to the system.

- ➔ **Power Off** The system remains turned off
- ➔ **Power On** The system turns on
- ➔ **Last State DEFAULT** The system returns to its previous state. If it was on, it turns itself on. If it was off, it remains off.

ITG-100-AL Embedded System

→ Power Saving Function (EUP) [Disabled]

Use the **Power Saving Function (EUP)** option to enable or disable the power saving function.

- **Disabled** **DEFAULT** Power saving function is disabled.
- **Enabled** Power saving function is enabled. It will reduce power consumption when the system is off.

→ OS Selection [Windows]

Use the **OS Selection** BIOS option to select the OS. Configuration options are listed below.

- Windows **DEFAULT**
- Android

5.4.2.1 PCI Express Configuration

Use the **PCI Express Configuration** menu (**BIOS Menu 18**) to select the support type of the PCIe Mini slot.

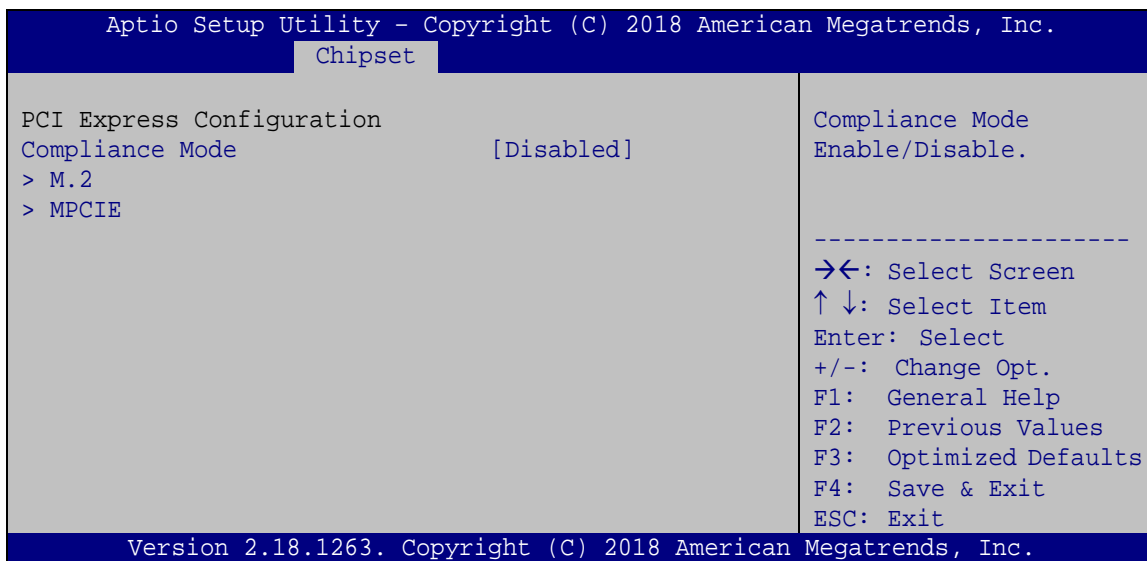

BIOS Menu 18: PCI Express Configuration

→ Compliance Mode [Disabled]

Use the **Compliance Mode** option to enable or disable the compliance mode.

- ➔ **Disabled** **DEFAULT** Disables the compliance mode.
- ➔ **Enabled** Enables the compliance mode.

The **M.2** and **MPCIE** submenus all contain the following options:

➔ **PCIe Speed [Auto]**

Use PCIe Speed option to select the speed type of the PCIe Mini slot. The following options are available:

- Auto **Default**
- Gen1
- Gen2

5.4.2.2 SCC Configuration

Use the **SCC Configuration** menu (**BIOS Menu 19**) to configure the SCC settings.

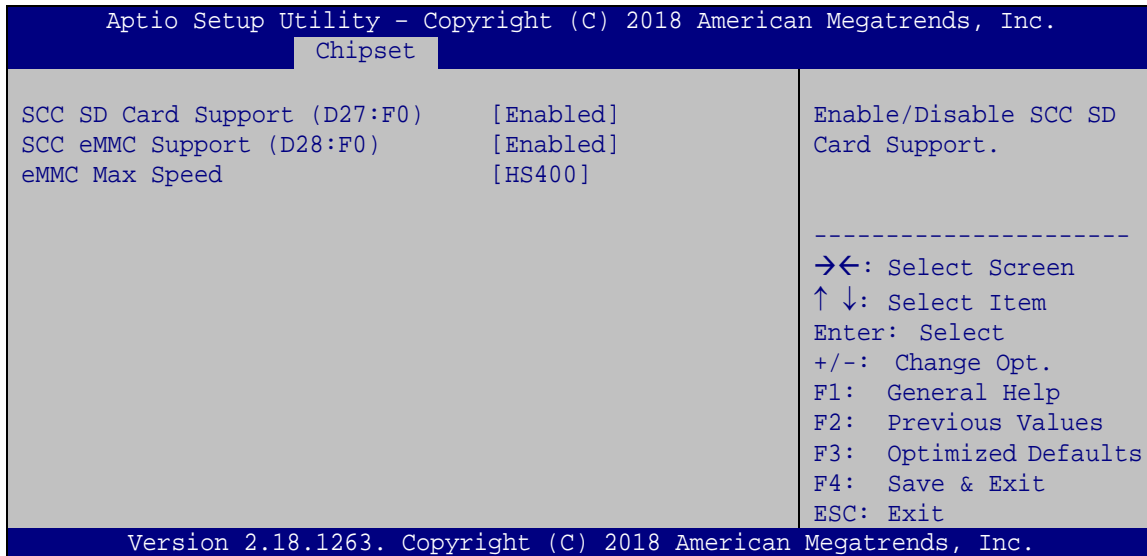

BIOS Menu 19: PCI Express Configuration

➔ **SCC SD Card Support [Enabled]**

Use the **SCC SD Card Support** option to enable or disable the SCC SD card support.

- ➔ **Disabled** Disables the SCC SD card support.

ITG-100-AL Embedded System

➔ **Enabled** **DEFAULT** Enables the SCC SD card support.

➔ **SCC eMMC Support [Enabled]**

Use the **SCC eMMC Support** option to enable or disable the SCC eMMC support.

➔ **Disabled** Disables the SCC eMMC support.

➔ **Enabled** **DEFAULT** Enables the SCC eMMC support.

➔ **eMMC Max Speed [HS400]**

Use **eMMC Max Speed** option to select the eMMC max speed. The following options are available:

- **HS400** **Default**
- HS200
- DDR50

5.5 Security

Use the **Security** menu (**BIOS Menu 20**) to set system and user passwords.

```

Aptio Setup Utility - Copyright (C) 2018 American Megatrends, Inc.
Main   Advanced   Chipset   Security   Boot   Save & Exit
-----
Password Description
If ONLY the Administrator's password is set,
then this only limits access to Setup and is
only asked for when entering Setup
If ONLY the User's password is set, then this
is a power on password and must be entered to
boot or enter Setup. In Setup the User will
have Administrator rights.
The password length must be:
Minimum length           3
Maximum length          20

Administrator Password
User Password

Set Setup Administrator
Password

-----
<->: Select Screen
↑ ↓: Select Item
Enter>Select
F1   General Help
F2   Previous Values
F3   Optimized
Defaults
F4   Save
ESC  Exit

Version 2.18.1263. Copyright (C) 2018 American Megatrends, Inc.
    
```

BIOS Menu 20: Security

→ **Administrator Password**

Use the **Administrator Password** to set or change a administrator password.

→ **User Password**

Use the **User Password** to set or change a user password.

5.6 Boot

Use the **Boot** menu (**BIOS Menu 19**) to configure system boot options.

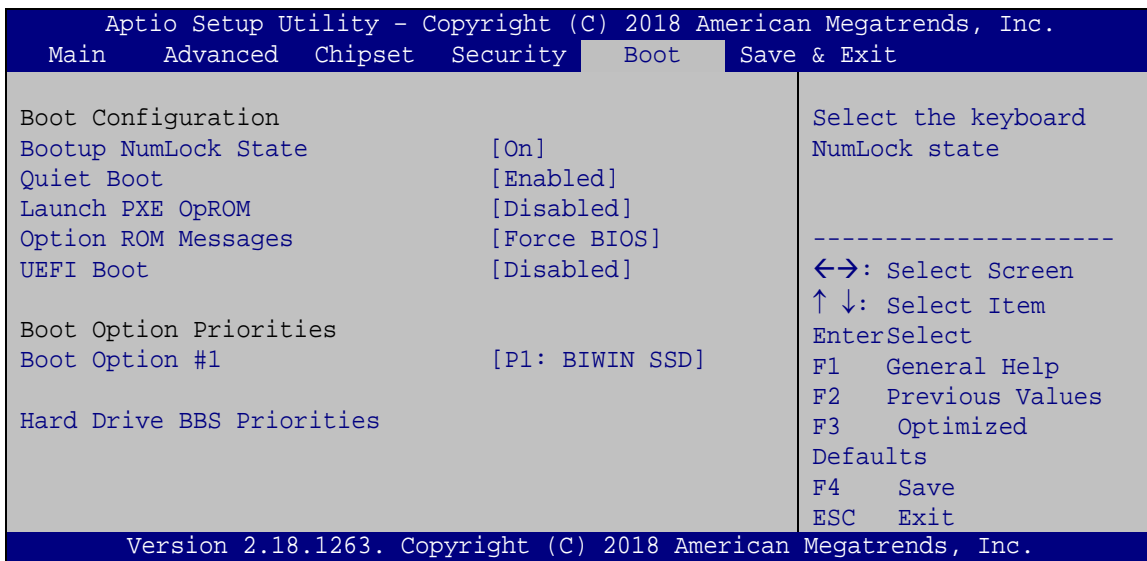

BIOS Menu 21: Boot

→ **Bootup NumLock State [On]**

Use the **Bootup NumLock State** BIOS option to specify if the number lock setting must be modified during boot up.

- **On** **DEFAULT** Allows the Number Lock on the keyboard to be enabled automatically when the computer system boots up. This allows the immediate use of the 10-key numeric keypad located on the right side of the keyboard. To confirm this, the Number Lock LED light on the keyboard is lit.

ITG-100-AL Embedded System

- **Off** Does not enable the keyboard Number Lock automatically. To use the 10-keys on the keyboard, press the Number Lock key located on the upper left-hand corner of the 10-key pad. The Number Lock LED on the keyboard lights up when the Number Lock is engaged.

→ Quiet Boot [Enabled]

Use the **Quiet Boot** BIOS option to select the screen display when the system boots.

- **Disabled** Normal POST messages displayed
- **Enabled** **DEFAULT** OEM Logo displayed instead of POST messages

→ Launch PXE OpROM [Disabled]

Use the **Launch PXE OpROM** option to enable or disable boot option for legacy network devices.

- **Disabled** **DEFAULT** Ignore all PXE Option ROMs
- **Enabled** Load PXE Option ROMs.

→ Option ROM Messages [Force BIOS]

Use the **Option ROM Messages** option to set the Option ROM display mode.

- **Force BIOS** **DEFAULT** Sets display mode to force BIOS.
- **Keep Current** Sets display mode to current.

→ UEFI Boot [Disabled]

Use the **UEFI Boot** option to enable or disable to boot from the UEFI devices.

- **Enabled** Boot from UEFI devices is enabled.

→ **Disabled** **DEFAULT** Boot from UEFI devices is disabled.

→ **Boot Option Priority**

Use the **Boot Option Priority** function to set the system boot sequence from the available devices. The drive sequence also depends on the boot sequence in the individual device section.

→ **Hard Drive BBS Priorities**

Use the **Hard Drive BBS Priorities** option to set the order of the legacy devices in this group.

5.7 Exit

Use the **Exit** menu (**BIOS Menu 22**) to load default BIOS values, optimal failsafe values and to save configuration changes.

```

Aptio Setup Utility - Copyright (C) 2018 American Megatrends, Inc.
Main   Advanced  Chipset  Security  Boot   Save & Exit
-----
Save Changes and Reset
Discard Changes and Reset

Restore Defaults
Save as User Defaults
Restore User Defaults

-----
<->: Select Screen
↑ ↓: Select Item
Enter>Select
F1   General Help
F2   Previous Values
F3   Optimized
Defaults
F4   Save
ESC  Exit

Version 2.18.1263. Copyright (C) 2018 American Megatrends, Inc.
    
```

BIOS Menu 22:Exit

ITG-100-AL Embedded System

→ Save Changes and Reset

Use the **Save Changes and Reset** option to save the changes made to the BIOS options and to exit the BIOS configuration setup program.

→ Discard Changes and Reset

Use the **Discard Changes and Reset** option to exit the system without saving the changes made to the BIOS configuration setup program.

→ Restore Defaults

Use the **Restore Defaults** option to load the optimal default values for each of the parameters on the Setup menus. **F3 key can be used for this operation.**

→ Save as User Defaults

Use the **Save as User Defaults** option to save the changes done so far as user defaults.

→ Restore User Defaults

Use the **Restore User Defaults** option to restore the user defaults to all the setup options.

Chapter

6

Software Installation

ITG-100-AL Embedded System

6.1.1 Available Drivers

All the drivers for the ITG-100-AL are available on IEI Resource Download Center (<https://download.ieiworld.com>). Type ITG-100-AL and press Enter to find all the relevant software, utilities, and documentation.

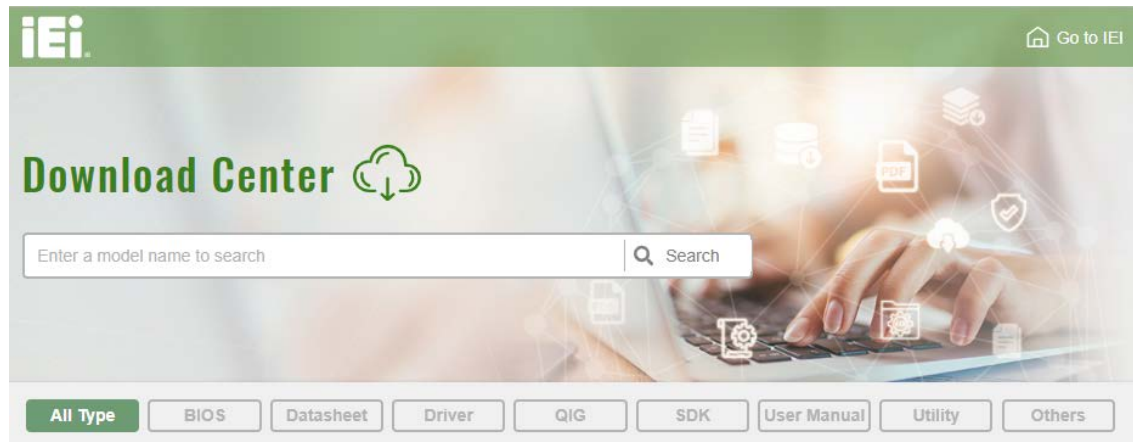
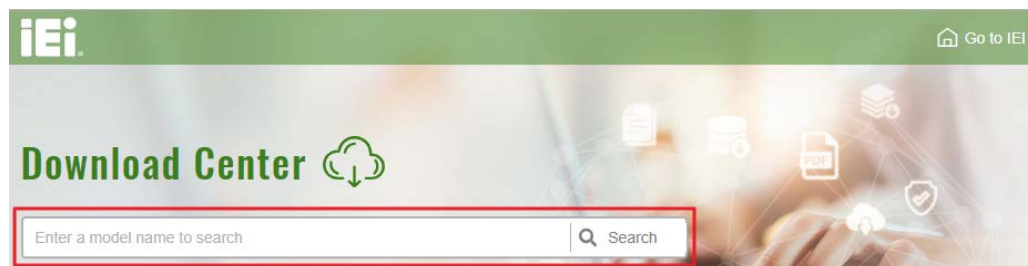

Figure 6-1: IEI Resource Download Center

6.1.2 Driver Download

To download drivers from IEI Resource Download Center, follow the steps below.

Step 5: Go to <https://download.ieiworld.com>. Type ITG-100-AL and press Enter.



Step 6: All product-related software, utilities, and documentation will be listed. You can choose **Driver** to filter the result.

[All Type](#)
[BIOS](#)
[Datasheet](#)
[Driver](#)
[QIG](#)
[SDK](#)
[User Manual](#)
[Utility](#)
[Others](#)

WAFER-BT-i1 [Product Info](#)

[Embedded Computer](#) ▶ [Single Board Computer](#) ▶ [Embedded Board](#)
 3.5" SBC with Intel® 22nm Atom™/Celeron® on-board SoC

Driver

File Name	Published	Version	File Checksum
 7B000-001033-RS V2.3.iso (2.23 GB)	2017/10/03	2.30	3B2DB1F792779A93A8F50DDBC3943E30

Step 7: Click the driver file name on the page and you will be prompted with the following window. You can download the entire ISO file (❶), or click the small arrow to find an individual driver and click the file name to download (❷).

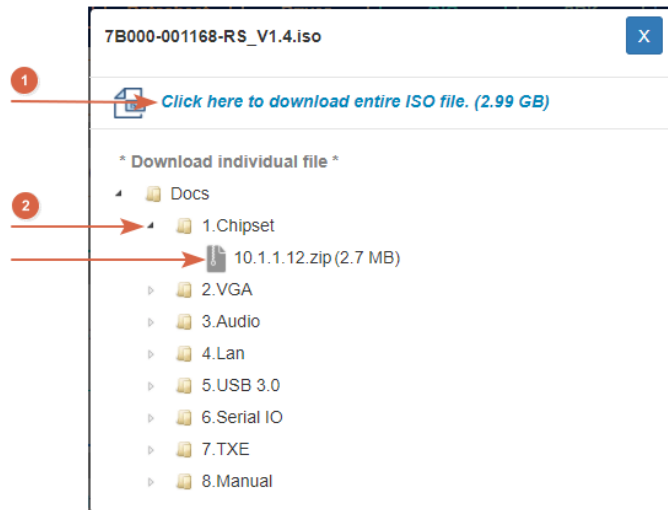

7B000-001168-RS_V1.4.iso

❶ [Click here to download entire ISO file. \(2.99 GB\)](#)

* Download individual file *

- Docs
 - 1.Chipset
 - ❷ 10.1.1.12.zip (2.7 MB)
 - 2.VGA
 - 3.Audio
 - 4.Lan
 - 5.USB 3.0
 - 6.Serial IO
 - 7.TXE
 - 8.Manual



NOTE:

To install software from the downloaded ISO image file in Windows 8, 8.1 or 10, double-click the ISO file to mount it as a virtual drive to view its content. On Windows 7 system, an additional tool (such as Virtual CD-ROM Control Panel from Microsoft) is needed to mount the file.

Appendix

A

Regulatory Compliance

DECLARATION OF CONFORMITY

This equipment is in conformity with the following EU directives:

- EMC Directive (2004/108/EC, 2014/30/EU)
- Low-Voltage Directive (2006/95/EC, 2014/35/EU)
- RoHS II Directive (2011/65/EU, 2015/863/EU)

If the user modifies and/or install other devices in the equipment, the CE conformity declaration may no longer apply.

If this equipment has telecommunications functionality, it also complies with the requirements of the Radio Equipment Directive 2014/53/EU.

English

IEI Integration Corp declares that this equipment is in compliance with the essential requirements and other relevant provisions of Directive 2014/53/EU.

Български [Bulgarian]

IEI Integration Corp. декларира, че този оборудване е в съответствие със съществените изисквания и другите приложим правила на Директива 2014/53/EU.

Česky [Czech]

IEI Integration Corp tímto prohlašuje, že tento zařizení je ve shodě s základními požadavky a dalšími příslušnými ustanoveními směrnice 2014/53/EU.

Dansk [Danish]

IEI Integration Corp erklærer herved, at følgende udstyr overholder de væsentlige krav og øvrige relevante krav i direktiv 2014/53/EU.

ITG-100-AL Embedded System

Deutsch [German]

IEI Integration Corp, erklärt dieses Gerät entspricht den grundlegenden Anforderungen und den weiteren entsprechenden Vorgaben der Richtlinie 2014/53/EU.

Eesti [Estonian]

IEI Integration Corp deklareerib seadme seadme vastavust direktiivi 2014/53/EÜ põhinõuetele ja nimetatud direktiivist tulenevatele teistele asjakohastele sätetele.

Español [Spanish]

IEI Integration Corp declara que el equipo cumple con los requisitos esenciales y cualesquiera otras disposiciones aplicables o exigibles de la Directiva 2014/53/EU.

Ελληνική [Greek]

IEI Integration Corp ΔΗΛΩΝΕΙ ΟΤΙ ΕΞΟΠΛΙΣΜΟΣ ΣΥΜΜΟΡΦΩΝΕΤΑΙ ΠΡΟΣ ΤΙΣ ΟΥΣΙΩΔΕΙΣ ΑΠΑΙΤΗΣΕΙΣ ΚΑΙ ΤΙΣ ΛΟΙΠΕΣ ΣΧΕΤΙΚΕΣ ΔΙΑΤΑΞΕΙΣ ΤΗΣ ΟΔΗΓΙΑΣ 2014/53/EU.

Français [French]

IEI Integration Corp déclare que l'appareil est conforme aux exigences essentielles et aux autres dispositions pertinentes de la directive 2014/53/EU.

Italiano [Italian]

IEI Integration Corp dichiara che questo apparecchio è conforme ai requisiti essenziali ed alle altre disposizioni pertinenti stabilite dalla direttiva 2014/53/EU.

Latviski [Latvian]

IEI Integration Corp deklarē, ka iekārta atbilst būtiskajām prasībām un citiem ar to saistītajiem noteikumiem Direktīvas 2014/53/EU.

Lietuvių [Lithuanian]

IEI Integration Corp deklaruoja, kad šis įranga atitinka esminius reikalavimus ir kitas 2014/53/EU Direktyvos nuostatas.

Nederlands [Dutch]

IEI Integration Corp dat het toestel toestel in overeenstemming is met de essentiële eisen en de andere relevante bepalingen van richtlijn 2014/53/EU.

Malti [Maltese]

IEI Integration Corp jiddikjara li dan prodott jikkonforma mal-ħtiġijiet essenzjali u ma provvedimenti oħrajn relevanti li hemm fid-Dirrettiva 2014/53/EU.

Magyar [Hungarian]

IEI Integration Corp nyilatkozom, hogy a berendezés megfelel a vonatkozó alapvető követelményeknek és az 2014/53/EU irányelv egyéb előírásainak.

Polski [Polish]

IEI Integration Corp oświadcza, że wyrobu jest zgodny z zasadniczymi wymogami oraz pozostałymi stosownymi postanowieniami Dyrektywy 2014/53/EU.

Português [Portuguese]

IEI Integration Corp declara que este equipamento está conforme com os requisitos essenciais e outras disposições da Directiva 2014/53/EU.

Româna [Romanian]

IEI Integration Corp declară că acest echipament este în conformitate cu cerințele esențiale și cu celelalte prevederi relevante ale Directivei 2014/53/EU.

ITG-100-AL Embedded System

Slovensko [Slovenian]

IEI Integration Corp izjavlja, da je ta opreme v skladu z bistvenimi zahtevami in ostalimi relevantnimi določili direktive 2014/53/EU.

Slovensky [Slovak]

IEI Integration Corp týmto vyhlasuje, že zariadenia spĺňa základné požiadavky a všetky príslušné ustanovenia Smernice 2014/53/EU.

Suomi [Finnish]

IEI Integration Corp vakuuttaa täten että laitteet on direktiivin 2014/53/EU oleellisten vaatimusten ja sitä koskevien direktiivin muiden ehtojen mukainen.

Svenska [Swedish]

IEI Integration Corp förklarar att denna utrustningstyp står i överensstämmelse med de väsentliga egenskapskrav och övriga relevanta bestämmelser som framgår av direktiv 2014/53/EU.

FCC WARNING



This equipment complies with Part 15 of the FCC Rules. Operation is subject to the following two conditions:

- This device may not cause harmful interference, and
- This device must accept any interference received, including interference that may cause undesired operation.

This equipment has been tested and found to comply with the limits for a Class A digital device, pursuant to part 15 of the FCC Rules. These limits are designed to provide reasonable protection against harmful interference when the equipment is operated in a commercial environment. This equipment generates, uses, and can radiate radio frequency energy and, if not installed and used in accordance with the instruction manual, may cause harmful interference to radio communications. Operation of this equipment in a residential area is likely to cause harmful interference in which case the user will be required to correct the interference at his own expense.

Federal Communication Commission Interference Statement

This equipment has been assembled with components that comply with the limits for a Class B digital device, pursuant to Part 15 of the FCC Rules. These limits are designed to provide reasonable protection against harmful interference in a residential installation. This equipment generates, uses and can radiate radio frequency energy and, if not installed and used in accordance with the instructions, may cause harmful interference to radio communications. However, there is no guarantee that interference will not occur in a particular installation. If this equipment does cause harmful interference to radio or television reception, which can be determined by turning the equipment off and on, the user is encouraged to try to correct the interference by one of the following measures:

- Reorient or relocate the receiving antenna.
- Increase the separation between the equipment and receiver.
- Connect the equipment into an outlet on a circuit different from that to which the receiver is connected.
- Consult the dealer or an experienced radio/TV technician for help.

Appendix

B

Safety Precautions

**WARNING:**

The precautions outlined in this chapter should be strictly followed. Failure to follow these precautions may result in permanent damage to the ITG-100-AL.

B.1 Safety Precautions

Please follow the safety precautions outlined in the sections that follow:

B.1.1 General Safety Precautions

Please ensure the following safety precautions are adhered to at all times.

- **Follow the electrostatic precautions** outlined below whenever the device is opened.
- **Make sure the power is turned off and the power cord is disconnected** whenever the ITG-100-AL is being installed, moved or modified.
- **To prevent the risk of electric shock, make sure power cord is unplugged from wall socket.** To fully disengage the power to the unit, please disconnect the power cord from the AC outlet. Refer servicing to qualified service personnel. The AC outlet shall be readily available and accessible.
- **Do not apply voltage levels that exceed the specified voltage range.** Doing so may cause fire and/or an electrical shock. Use a power cord that matches the voltage of the power outlet, which has been approved and complies with the safety standard of your particular country.
- **Electric shocks can occur** if the ITG-100-AL chassis is opened when it is running. To avoid risk of electric shock, this device must only be connected to a supply mains with protective earth.
- **Do not drop or insert any objects** into the ventilation openings of the ITG-100-AL.

ITG-100-AL Embedded System

- **If considerable amounts of dust, water, or fluids enter the device**, turn off the power supply immediately, unplug the power cord, and contact the ITG-100-AL vendor.
- **DO NOT:**
 - Drop the device against a hard surface.
 - Strike or exert excessive force onto the LCD panel.
 - Touch any of the LCD panels with a sharp object
 - In a site where the ambient temperature exceeds the rated temperature

B.1.2 Anti-static Precautions



WARNING:

Failure to take ESD precautions during the installation of the ITG-100-AL may result in permanent damage to the ITG-100-AL and severe injury to the user.

Electrostatic discharge (ESD) can cause serious damage to electronic components, including the ITG-100-AL. Dry climates are especially susceptible to ESD. It is therefore critical that whenever the ITG-100-AL is opened and any of the electrical components are handled, the following anti-static precautions are strictly adhered to.

- **Wear an anti-static wristband:** Wearing a simple anti-static wristband can help to prevent ESD from damaging any electrical component.
- **Self-grounding:** Before handling any electrical component, touch any grounded conducting material. During the time the electrical component is handled, frequently touch any conducting materials that are connected to the ground.
- **Use an anti-static pad:** When configuring or working with an electrical component, place it on an anti-static pad. This reduces the possibility of ESD damage.
- **Only handle the edges of the electrical component:** When handling the electrical component, hold the electrical component by its edges.

B.1.3 Product Disposal

**CAUTION:**

Risk of explosion if battery is replaced by an incorrect type. Only certified engineers should replace the on-board battery.

Dispose of used batteries according to instructions and local regulations.

- Outside the European Union – If you wish to dispose of used electrical and electronic products outside the European Union, please contact your local authority so as to comply with the correct disposal method.
- Within the European Union – The device that produces less waste and is easier to recycle is classified as electronic device in terms of the European Directive 2012/19/EU (WEEE), and must not be disposed of as domestic garbage.



EU-wide legislation, as implemented in each Member State, requires that waste electrical and electronic products carrying the mark (left) must be disposed of separately from normal household waste. This includes monitors and electrical accessories, such as signal cables or power cords. When you need to dispose of your display products, please follow the guidance of your local authority, or ask the shop where you purchased the product. The mark on electrical and electronic products only applies to the current European Union Member States.

Please follow the national guidelines for electrical and electronic product disposal.

ITG-100-AL Embedded System

B.2 Maintenance and Cleaning Precautions

When maintaining or cleaning the ITG-100-AL, please follow the guidelines below.



WARNING:

- For safety reasons, turn-off the power and unplug the panel PC before cleaning.
 - If you dropped any material or liquid such as water onto the panel PC when cleaning, unplug the power cable immediately and contact your dealer or the nearest service center. Always make sure your hands are dry when unplugging the power cable.
-

B.2.1 Maintenance and Cleaning

Prior to cleaning any part or component of the ITG-100-AL, please read the details below.

- Except for the LCD panel, never spray or squirt liquids directly onto any other components. To clean the LCD panel, gently wipe it with a piece of soft dry cloth or a slightly moistened cloth.
- The interior of the device does not require cleaning. Keep fluids away from the device interior.
- Be cautious of all small removable components when vacuuming the device.
- Never drop any objects or liquids through the openings of the device.
- Be cautious of any possible allergic reactions to solvents or chemicals used when cleaning the device.
- Avoid eating, drinking and smoking within vicinity of the device.

B.2.2 Cleaning Tools

Some components in the ITG-100-AL may only be cleaned using a product specifically designed for the purpose. In such case, the product will be explicitly mentioned in the cleaning tips. Below is a list of items to use when cleaning the ITG-100-AL.

- **Cloth** – Although paper towels or tissues can be used, a soft, clean piece of cloth is recommended when cleaning the device.
- **Water or rubbing alcohol** – A cloth moistened with water or rubbing alcohol

can be used to clean the device.

- **Using solvents** – The use of solvents is not recommended when cleaning the device as they may damage the plastic parts.
- **Vacuum cleaner** – Using a vacuum specifically designed for computers is one of the best methods of cleaning the device. Dust and dirt can restrict the airflow in the device and cause its circuitry to corrode.
- **Cotton swabs** – Cotton swabs moistened with rubbing alcohol or water are excellent tools for wiping hard to reach areas.
- **Foam swabs** – Whenever possible, it is best to use lint free swabs such as foam swabs for cleaning.

Appendix

C

BIOS Menu Options

Below is a list of BIOS configuration options in the BIOS chapter.

➔ System Date [xx/xx/xx]	45
➔ System Time [xx:xx:xx]	45
➔ ACPI Sleep State [S3 only (Suspend to RAM)]	46
➔ Serial Port [Enabled].....	48
➔ Device Mode [RS232].....	48
➔ Serial Port [Enabled].....	48
➔ Device Mode [RS232].....	48
➔ Serial Port [Enabled].....	49
➔ Serial Port [Enabled].....	49
➔ PC Health Status	50
➔ Wake system with Fixed Time [Disabled].....	51
➔ Console Redirection [Disabled]	52
➔ Terminal Type [ANSI].....	53
➔ Bits per second [115200].....	53
➔ Data Bits [8]	54
➔ Parity [None].....	54
➔ Stop Bits [1].....	54
➔ Intel® Virtualization Technology [Disabled].....	55
➔ EIST [Enabled].....	55
➔ C-States [Disabled]	56
➔ USB Devices	56
➔ Legacy USB Support [Enabled].....	57
➔ Auto Recovery Function [Disabled].....	57
➔ SATA Mode Selection [AHCI].....	58
➔ Hot Plug [Disabled].....	58
➔ Memory Information	60
➔ Primary Display [IGD].....	61
➔ DVMT Pre-Allocated [256MB].....	61
➔ DVMT Total Gfx Mem [Max].....	62
➔ Restore AC Power Loss [Last State]	62
➔ Power Saving Function (EUP) [Disabled].....	63
➔ OS Selection [Windows].....	63
➔ Compliance Mode [Disabled].....	63

ITG-100-AL Embedded System

➔	PCIe Speed [Auto].....	64
➔	SCC SD Card Support [Enabled].....	64
➔	SCC eMMC Support [Enabled].....	65
➔	eMMC Max Speed [HS400]	65
➔	Administrator Password	66
➔	User Password	66
➔	Bootup NumLock State [On].....	66
➔	Quiet Boot [Enabled]	67
➔	Launch PXE OpROM [Disabled]	67
➔	Option ROM Messages [Force BIOS].....	67
➔	UEFI Boot [Disabled]	67
➔	Boot Option Priority.....	68
➔	Hard Drive BBS Priorities.....	68
➔	Save Changes and Reset	69
➔	Discard Changes and Reset	69
➔	Restore Defaults	69
➔	Save as User Defaults	69
➔	Restore User Defaults	69

Appendix

D

Terminology

ITG-100-AL Embedded System

AC '97	Audio Codec 97 (AC'97) refers to a codec standard developed by Intel® in 1997.
ACPI	Advanced Configuration and Power Interface (ACPI) is an OS-directed configuration, power management, and thermal management interface.
AHCI	Advanced Host Controller Interface (AHCI) is a SATA Host controller register-level interface.
ATA	The Advanced Technology Attachment (ATA) interface connects storage devices including hard disks and CD-ROM drives to a computer.
ARMD	An ATAPI Removable Media Device (ARMD) is any ATAPI device that supports removable media, besides CD and DVD drives.
ASKIR	Amplitude Shift Keyed Infrared (ASKIR) is a form of modulation that represents a digital signal by varying the amplitude (“volume”) of the signal. A low amplitude signal represents a binary 0, while a high amplitude signal represents a binary 1.
BIOS	The Basic Input/Output System (BIOS) is firmware that is first run when the computer is turned on and can be configured by the end user
CODEC	The Compressor-Decompressor (CODEC) encodes and decodes digital audio data on the system.
CompactFlash®	CompactFlash® is a solid-state storage device. CompactFlash® devices use flash memory in a standard size enclosure. Type II is thicker than Type I, but a Type II slot can support both types.
CMOS	Complimentary metal-oxide-conductor is an integrated circuit used in chips like static RAM and microprocessors.
COM	COM refers to serial ports. Serial ports offer serial communication to expansion devices. The serial port on a personal computer is usually a male D-sub 9 connector.
DAC	The Digital-to-Analog Converter (DAC) converts digital signals to analog signals.
DDR	Double Data Rate refers to a data bus transferring data on both the rising and falling edges of the clock signal.

DMA	Direct Memory Access (DMA) enables some peripheral devices to bypass the system processor and communicate directly with the system memory.
DIMM	Dual Inline Memory Modules are a type of RAM that offer a 64-bit data bus and have separate electrical contacts on each side of the module.
DIO	The digital inputs and digital outputs are general control signals that control the on/off circuit of external devices or TTL devices. Data can be read or written to the selected address to enable the DIO functions.
EHCI	The Enhanced Host Controller Interface (EHCI) specification is a register-level interface description for USB 2.0 Host Controllers.
EIDE	Enhanced IDE (EIDE) is a newer IDE interface standard that has data transfer rates between 4.0 MBps and 16.6 MBps.
EIST	Enhanced Intel® SpeedStep Technology (EIST) allows users to modify the power consumption levels and processor performance through application software. The application software changes the bus-to-core frequency ratio and the processor core voltage.
FSB	The Front Side Bus (FSB) is the bi-directional communication channel between the processor and the Northbridge chipset.
GbE	Gigabit Ethernet (GbE) is an Ethernet version that transfers data at 1.0 Gbps and complies with the IEEE 802.3-2005 standard.
GPIO	General purpose input
HDD	Hard disk drive (HDD) is a type of magnetic, non-volatile computer storage device that stores digitally encoded data.
ICH	The Input/Output Control Hub (ICH) is an Intel® Southbridge chipset.
IrDA	Infrared Data Association (IrDA) specify infrared data transmission protocols used to enable electronic devices to wirelessly communicate with each other.
L1 Cache	The Level 1 Cache (L1 Cache) is a small memory cache built into the system processor.
L2 Cache	The Level 2 Cache (L2 Cache) is an external processor memory cache.

ITG-100-AL Embedded System

LCD	Liquid crystal display (LCD) is a flat, low-power display device that consists of two polarizing plates with a liquid crystal panel in between.
LVDS	Low-voltage differential signaling (LVDS) is a dual-wire, high-speed differential electrical signaling system commonly used to connect LCD displays to a computer.
POST	The Power-on Self Test (POST) is the pre-boot actions the system performs when the system is turned-on.
RAM	Random Access Memory (RAM) is volatile memory that loses data when power is lost. RAM has very fast data transfer rates compared to other storage like hard drives.
SATA	Serial ATA (SATA) is a serial communications bus designed for data transfers between storage devices and the computer chipsets. The SATA bus has transfer speeds up to 1.5 Gbps and the SATA II bus has data transfer speeds of up to 3.0 Gbps.
S.M.A.R.T	Self Monitoring Analysis and Reporting Technology (S.M.A.R.T) refers to automatic status checking technology implemented on hard disk drives.
UART	Universal Asynchronous Receiver-transmitter (UART) is responsible for asynchronous communications on the system and manages the system's serial communication (COM) ports.
UHCI	The Universal Host Controller Interface (UHCI) specification is a register-level interface description for USB 1.1 Host Controllers.
USB	The Universal Serial Bus (USB) is an external bus standard for interfacing devices. USB 1.1 supports 12Mbps data transfer rates and USB 2.0 supports 480Mbps data transfer rates.
VGA	The Video Graphics Array (VGA) is a graphics display system developed by IBM.

Appendix

E

Hazardous Materials Disclosure

ITG-100-AL Embedded System

The details provided in this appendix are to ensure that the product is compliant with the Peoples Republic of China (China) RoHS standards. The table below acknowledges the presences of small quantities of certain materials in the product, and is applicable to China RoHS only.

A label will be placed on each product to indicate the estimated “Environmentally Friendly Use Period” (EFUP). This is an estimate of the number of years that these substances would “not leak out or undergo abrupt change.” This product may contain replaceable sub-assemblies/components which have a shorter EFUP such as batteries and lamps. These components will be separately marked.

Please refer to the following table.

Part Name	Toxic or Hazardous Substances and Elements					
	Lead (Pb)	Mercury (Hg)	Cadmium (Cd)	Hexavalent Chromium (CR(VI))	Polybrominated Biphenyls (PBB)	Polybrominated Diphenyl Ethers (PBDE)
Housing	O	O	O	O	O	O
Display	O	O	O	O	O	O
Printed Circuit Board	O	O	O	O	O	O
Metal Fasteners	O	O	O	O	O	O
Cable Assembly	O	O	O	O	O	O
Fan Assembly	O	O	O	O	O	O
Power Supply Assemblies	O	O	O	O	O	O
Battery	O	O	O	O	O	O

O: This toxic or hazardous substance is contained in all of the homogeneous materials for the part is below the limit requirement in SJ/T11363-2006 (now replaced by GB/T 26572-2011).

X: This toxic or hazardous substance is contained in at least one of the homogeneous materials for this part is above the limit requirement in SJ/T11363-2006 (now replaced by GB/T 26572-2011).

此附件旨在确保本产品符合中国 RoHS 标准。以下表格标示此产品中某有毒物质的含量符合中国 RoHS 标准规定的限量要求。

本产品上会附有“环境友好使用期限”的标签，此期限是估算这些物质“不会有泄漏或突变”的年限。本产品可能包含有较短的环境友好使用期限的可替换元件，像是电池或灯管，这些元件将会单独标示出来。

部件名称	有毒有害物质或元素					
	铅 (Pb)	汞 (Hg)	镉 (Cd)	六价铬 (CR(VI))	多溴联苯 (PBB)	多溴二苯 醚 (PBDE)
壳体	○	○	○	○	○	○
显示	○	○	○	○	○	○
印刷电路板	○	○	○	○	○	○
金属螺帽	○	○	○	○	○	○
电缆组装	○	○	○	○	○	○
风扇组装	○	○	○	○	○	○
电力供应组装	○	○	○	○	○	○
电池	○	○	○	○	○	○

○: 表示该有毒有害物质在该部件所有物质材料中的含量均在 SJ/T 11363-2006 (现由 GB/T 26572-2011 取代) 标准规定的限量要求以下。

X: 表示该有毒有害物质至少在该部件的某一均质材料中的含量超出 SJ/T 11363-2006 (现由 GB/T 26572-2011 取代) 标准规定的限量要求。