



**MODEL:  
IVS-110**

**IEI Fanless Embedded System with Intel® Atom® x7-E3950 Processor, RS-232/422/485, OBD-II, On-board GPS, HDMI, VGA, Dual SIM Slot, RoHS Compliant,**

# User Manual

# Revision

---

Date	Version	Changes
April 30, 2018	1.01	Modified specifications
January 31, 2018	1.00	Initial release



# Safety Instructions

---

- en** Warning! Read the user manual before connecting the system to the power source.
- de** Vorsicht! Bitte lesen Sie die Bedienungsanleitung, bevor Sie das System an eine Stromquelle anschließen.
- fr** Attention! Avant de brancher le système à la source d'alimentation, consultez le mode d'emploi.
- it** Avvertenza! Consultare il manuale utente prima di collegare il sistema all'alimentatore.
- es** Atención! Lea atentamente este manual del usuario antes de operar la fuente de alimentación.
- zh** 警告！在將系統連接到電源之前，請仔細閱讀使用手冊。
- cn** 警告！在將系統連接到電源之前，請仔細閱讀使用手冊。
- 

- en** Warning! To prevent the system from overheating, do not operate it in an area that exceeds the maximum operating temperature described in the user manual.
- de** Vorsicht! Um eine Überhitzung des Systems zu vermeiden, betreiben Sie es ausschließlich im zulässigen Betriebstemperaturbereich. Dieser ist in der Bedienungsanleitung vermerkt.
- fr** Attention! Pour éviter la surchauffe du système, ne l'utilisez pas dans une zone dont la température dépasse les limites décrits dans le mode d'emploi.
- it** Avvertenza! Per evitare che il sistema si surriscaldi, non utilizzarlo in aree che superino la temperatura massima d'esercizio descritta nel manuale utente.
- es** Atención! Para evitar el excesivo calentamiento del sistema, no opere en las condiciones de temperatura superior a lo recomendado en este manual del usuario.
- zh** 警告！為防止系統過熱，不要在超過使用手冊上記載的產品工作溫度範圍之外操作此系統。
- cn** 警告！為防止系統過熱，不要在超過使用手冊上記載的產品工作溫度範圍之外操作此系統。
-

- en** Warning! Use only the adapter and power cord approved for this system. Use of another type of adapter may risk fire or explosion. Please refer to the user manual for the power adapter specifications.
- de** Vorsicht! Nur zugelassene Netzteile und Netzkabel dürfen verwendet werden. Die Benutzung von anderen Netzteilen kann einen Brand oder eine Explosion zur Folge haben. Prüfen Sie die jeweiligen Spezifikationen in der Bedienungsanleitung.
- fr** Attention! Utilisez exclusivement le câble d'alimentation et l'adaptateur homologués pour ce système. L'utilisation d'un autre type d'adaptateur risquerait de provoquer un incendie ou une explosion. Veuillez référer au mode d'emploi pour les spécifications de l'adaptateur d'alimentation.
- it** Avvertenza! Utilizzare solo l'adattatore e il cavo di alimentazione approvati per questo sistema. L'uso di un altro tipo di adattatore può causare rischio d'incendio o esplosione. Si prega di fare riferimento al manuale utente per le specifiche sull'alimentazione.
- es** Atención! Utilice solamente el adaptador de corriente alterna (CA) con Marcas Conformidad otorgadas. Cualquier otro adaptador no otorgado aumenta el riesgo de explosión o incendio. Por favor consulte el manual del usuario para las especificaciones del adaptador de alimentación.
- zh** 警告！只能使用經過認證、適用於本系統的電源變壓器與電源線。使用不適用的電源變壓器將可能導致火災或爆炸。電源變壓器規格請參考使用手冊。
- cn** 警告！只能使用经过认证，适用于本系统的电源适配器与电源线。使用不适用的电源适配器将可能导致火灾或爆炸。电源适配器规格请参考使用手冊。

- 
- en** Warning! Ultimate disposal of this product should be handled according to all national laws and regulations.
- de** Vorsicht! Die Entsorgung dieses Produkts sollte gemäß allen Bestimmungen und Gesetzen des Landes erfolgen.
- fr** Attention! La mise au rebut ou le recyclage de ce produit sont généralement soumis aux lois et/ou directives de respect de l'environnement. Renseignez-vous auprès de l'organisme compétent.
- it** Avvertenza! Lo smaltimento di questo prodotto deve essere eseguito secondo le leggi e i regolamenti locali.
- es** Atención! La disposición final de residuos de este producto se debe cumplir con las normativas y leyes del país.
- zh** 警告！本產品的廢棄處理應根據該國家的法律和規章進行。
- cn** 警告！本产品的废弃处理应根据该国家的法律和规章进行。
-

# Copyright

---

## **COPYRIGHT NOTICE**

The information in this document is subject to change without prior notice in order to improve reliability, design and function and does not represent a commitment on the part of the manufacturer.

In no event will the manufacturer be liable for direct, indirect, special, incidental, or consequential damages arising out of the use or inability to use the product or documentation, even if advised of the possibility of such damages.

This document contains proprietary information protected by copyright. All rights are reserved. No part of this manual may be reproduced by any mechanical, electronic, or other means in any form without prior written permission of the manufacturer.

## **TRADEMARKS**

All registered trademarks and product names mentioned herein are used for identification purposes only and may be trademarks and/or registered trademarks of their respective owners.



# Manual Conventions

---



## **WARNING**

Warnings appear where overlooked details may cause damage to the equipment or result in personal injury. Warnings should be taken seriously.



## **CAUTION**

Cautionary messages should be heeded to help reduce the chance of losing data or damaging the product.



## **NOTE**

These messages inform the reader of essential but non-critical information. These messages should be read carefully as any directions or instructions contained therein can help avoid making mistakes.



## **HOT SURFACE**

This symbol indicates a hot surface that should not be touched without taking care.

# Table of Contents

<b>1 INTRODUCTION.....</b>	<b>1</b>
1.1 OVERVIEW.....	2
1.2 BENEFITS .....	2
1.3 FEATURES.....	3
1.4 FRONT PANEL.....	3
1.4.1 LED Indicators.....	4
1.5 REAR PANEL.....	5
1.6 BOTTOM PANEL.....	6
1.7 DIMENSIONS.....	7
1.8 TECHNICAL SPECIFICATIONS .....	8
<b>2 UNPACKING .....</b>	<b>10</b>
2.1 UNPACKING.....	11
2.2 PACKING LIST.....	11
2.3 OPTIONAL ITEMS.....	12
<b>3 INSTALLATION .....</b>	<b>14</b>
3.1 ANTI-STATIC PRECAUTIONS .....	15
3.2 INSTALLATION PRECAUTIONS .....	15
3.2.1 High Surface Temperature .....	16
3.3 INSTALLATION PROCEDURE .....	16
3.4 OPEN THE BOTTOM COVER .....	17
3.5 PCIE MINI / mSATA CARD INSTALLATION .....	18
3.5.1 mSATA/E-Window Module Slot (MINI-PCIE3) Pinouts .....	20
3.6 WLAN/WWAN MODULE INSTALLATION .....	21
3.6.1 WWAN Module Slot (MINI-PCIE1) Pinouts.....	22
3.6.2 WLAN Module Slot (MINI-PCIE2) Pinouts.....	23
3.7 SIM CARD INSTALLATION .....	24
3.8 SOLID-STATE DRIVE INSTALLATION .....	26
3.9 MOUNTING THE SYSTEM .....	28
3.9.1 VESA Mount.....	29

3.10 EXTERNAL I/O CONNECTORS .....	30
3.10.1 COM Port Connection .....	30
3.10.2 DIO Connection .....	31
3.10.3 OBD-II Connection .....	32
3.11 POWER-ON PROCEDURE .....	33
3.11.1 Installation Checklist .....	33
3.11.2 Power Input Connection .....	34
3.11.3 Power-on Procedure .....	35
3.12 DRIVER INSTALLATION .....	36
3.13 MOBILE AP .....	37
3.13.1 Installation .....	37
3.13.2 Usage .....	38
<b>4 BIOS .....</b>	<b>39</b>
4.1 INTRODUCTION .....	40
4.1.1 Starting Setup .....	40
4.1.2 Using Setup .....	40
4.1.3 Getting Help .....	41
4.1.4 BIOS Menu Bar .....	41
4.2 MAIN .....	42
4.3 ADVANCED .....	43
4.3.1 Trusted Computing .....	44
4.3.2 ACPI Settings .....	45
4.3.3 F81866 Super IO Configuration .....	46
4.3.3.1 Serial Port n Configuration .....	46
4.3.4 F81866 H/W Monitor .....	50
4.3.4.1 Smart Fan Mode Configuration .....	51
4.3.5 Power Management .....	53
4.3.5.1 Power State .....	54
4.3.6 USB Configuration .....	55
4.3.7 CPU Configuration .....	56
4.3.8 RTC Wake Settings .....	58
4.3.9 Serial Port Console Redirection .....	59
4.3.9.1 Legacy Console Redirection Settings .....	60
4.3.10 IEI Feature .....	61



## IVS-110 Embedded System

4.4 CHIPSET .....	62
4.4.1 North Bridge Configuration.....	63
4.4.1.1 Intel IGD Configuration.....	63
4.4.2 South Bridge Configuration.....	65
4.4.2.1 HD-Audio Configuration .....	66
4.4.2.2 PCI Express Configuration .....	67
4.4.2.3 SATA Configuration.....	70
4.5 SECURITY.....	72
4.6 BOOT.....	73
4.7 SAVE & EXIT .....	75
<b>5 TROUBLESHOOTING AND MAINTENANCE .....</b>	<b>77</b>
5.1 SYSTEM MAINTENANCE OVERVIEW .....	78
5.2 SYSTEM TROUBLESHOOTING.....	78
5.2.1 The System Doesn't Turn On.....	78
5.2.2 The System Doesn't Boot Up.....	79
5.2.3 More Troubleshooting .....	79
5.3 MAINTENANCE.....	79
5.3.1 TXE Override Jumper .....	80
<b>6 INTERFACE CONNECTORS .....</b>	<b>81</b>
6.1 PERIPHERAL INTERFACE CONNECTORS.....	82
6.2 INTERNAL PERIPHERAL CONNECTORS .....	83
6.2.1 Battery Connector (BT1).....	83
6.2.2 MCU Programming Connector (JMCU1).....	84
6.2.3 OBD-II Programming Connector (JOB D1) .....	84
6.2.4 SATA Power Connector (SATA_PWR1).....	84
6.2.5 SPI Flash Connector, BIOS (J_SPI1) .....	85
6.2.6 TPM Connector (TPM1, Debug Only).....	85
<b>A REGULATORY COMPLIANCE .....</b>	<b>86</b>
<b>B SAFETY PRECAUTIONS .....</b>	<b>91</b>
B.1 SAFETY PRECAUTIONS.....	92
B.1.1 General Safety Precautions .....	92
B.1.2 Anti-static Precautions .....	93

*B.1.3 Product Disposal* ..... 94

**B.2 MAINTENANCE AND CLEANING PRECAUTIONS** ..... 95

*B.2.1 Maintenance and Cleaning*..... 95

*B.2.2 Cleaning Tools*..... 95

**C BIOS MENU OPTIONS**..... **97**

    C.1 BIOS CONFIGURATION OPTIONS ..... 98

**D WATCHDOG TIMER** ..... **100**

**E HAZARDOUS MATERIALS DISCLOSURE** ..... **103**

# List of Figures

Figure 1-1: IVS-110 Series Embedded System .....	2
Figure 1-2: Front Panel .....	3
Figure 1-3: LED Indicators .....	4
Figure 1-4: Rear Panel.....	5
Figure 1-5: Bottom Panel .....	6
Figure 1-6: Dimensions (mm).....	7
Figure 3-1: Bottom Panel Retention Screws.....	18
Figure 3-2: PCIe Mini Slot Location .....	19
Figure 3-3: Inserting the Full-size PCIe Mini Card into the Slot at an Angle .....	19
Figure 3-4: Securing the Full-size PCIe Mini Card .....	20
Figure 3-5: WLAN and WWAN Card Slot Locations.....	21
Figure 3-6: Connecting RF Cables.....	22
Figure 3-7: SIM Card Slot Cover Retention Screws .....	24
Figure 3-8: SIM Card Slot Locations.....	25
Figure 3-9: SSD Bracket Retention Screws .....	26
Figure 3-10: SSD Retention Screws.....	27
Figure 3-11: Mounting Bracket Retention Screws .....	28
Figure 3-12: VESA Mounting Retention Screw Holes.....	29
Figure 3-13: RS-232/422/485 Connector (COM1).....	30
Figure 3-14: DIO Connector.....	31
Figure 3-15: OBD-II Connector .....	32
Figure 3-16: OBD-II Cable and Connector Pinouts .....	33
Figure 3-17: Power Input Connector.....	34
Figure 3-18: ACC Power Cable.....	34
Figure 3-19: Optional Cigarette Lighter Cable.....	35
Figure 3-20: Optional Power Adapter and Transfer Cable .....	35
Figure 3-21: Power Button.....	36
Figure 3-22: IEI Resource Download Center.....	36
Figure 3-23: Mobile AP–Connection .....	38
Figure 5-1: TXE Override Jumper Location .....	80
Figure 6-1: Main Board Layout Diagram .....	82

# List of Tables

---

Table 1-1: LED Indicators .....	4
Table 1-2: Technical Specifications.....	9
Table 2-1: Package List.....	12
Table 2-2: Optional Items.....	13
Table 3-1: mSATA/E-Window Module Slot (MINI-PCIE3) Pinouts.....	21
Table 3-2: WWAN Module Slot (MINI-PCIE1) Pinouts .....	23
Table 3-3: WLAN Module Slot (MINI-PCIE2) Pinouts.....	24
Table 3-4: RS-232/422/485 Connector Pinouts .....	30
Table 3-5: DIO Connector Pinouts .....	31
Table 3-6: OBD-II Connector Pinouts .....	32
Table 3-7: Power Input Connector Pinouts .....	34
Table 4-1: BIOS Navigation Keys .....	41
Table 4-2: Power State and Ignition System.....	54
Table 5-1: TXE Override Jumper Settings.....	80
Table 6-1: Peripheral Interface Connectors .....	83
Table 6-2: Battery Connector (BT1) Pinouts.....	83
Table 6-3: MCU Programming Connector (JMCU1) Pinouts .....	84
Table 6-4: OBD-II Programming Connector (JOB1) Pinouts .....	84
Table 6-5: SATA Power Connector (SATA_PWR1) Pinouts .....	84
Table 6-6: SPI Flash Connector (J_SPI1) Pinouts .....	85
Table 6-7: TPM Connector (TPM1, Debug Only) Pinouts.....	85

# List of BIOS Menus

---

BIOS Menu 1: Main .....	42
BIOS Menu 2: Advanced .....	43
BIOS Menu 3: Trusted Computing .....	44
BIOS Menu 4: ACPI Settings .....	45
BIOS Menu 5: F81866 Super IO Configuration .....	46
BIOS Menu 6: Serial Port n Configuration Menu .....	46
BIOS Menu 7: F81866 H/W Monitor .....	50
BIOS Menu 8: Smart Fan Mode Configuration .....	51
BIOS Menu 9: Power Management .....	53
BIOS Menu 10: USB Configuration .....	55
BIOS Menu 11: CPU Configuration .....	56
BIOS Menu 12: RTC Wake Settings .....	58
BIOS Menu 13: Serial Port Console Redirection .....	59
BIOS Menu 14: Legacy Console Redirection Settings .....	60
BIOS Menu 15: IEI Feature .....	61
BIOS Menu 16: Chipset .....	62
BIOS Menu 17: North Bridge .....	63
BIOS Menu 18: Intel IGD Configuration .....	63
BIOS Menu 19: South Bridge .....	65
BIOS Menu 20: HD-Audio Configuration .....	66
BIOS Menu 21: PCI Express Configuration .....	67
BIOS Menu 22: RTL8111GN LAN .....	68
BIOS Menu 23: MINI-PCIE .....	69
BIOS Menu 24: SATA Configuration .....	70
BIOS Menu 25: Security .....	72
BIOS Menu 26: Boot .....	73
BIOS Menu 27: Save & Exit .....	75





Chapter

1

# Introduction

---

## 1.1 Overview



**Figure 1-1: IVS-110 Series Embedded System**

The IVS-110 fanless embedded system is powered by Intel® Intel® Atom® x7-E3950 processor. It is designed for in-vehicle applications that require minimum installation space.

The IVS-110 accepts a wide range of DC power input (9 V – 36 V), allowing it to be powered anywhere. Wi-Fi and WWAN capabilities plus one RJ-45 Ethernet connector ensure smooth network connectivity. The display interface options include VGA and HDMI that supports resolutions up to 3840x2160 @ 30Hz.

Four USB 3.0 ports, one RS-232/422/485 port, one OBD-II port and one digital I/O port provide rich I/O options for various applications. The IVS-110 embedded systems are all capable of supporting one 2.5" SATA 6Gb/s solid-state drives.

## 1.2 Benefits

The IVS-110 embedded system has the following benefits:

- Complete integration saves solution development time and cost
- Secure storage with SATA SSD and mSATA supported
- Compact size saves space
- Powerful Intel® processor and motherboard ensures rigorous processing needs can be met

## IVS-110 Embedded System

### 1.3 Features

The IVS-110 has the following features

- RoHS compliant design
- Fanless system
- Intel® Atom® x7-E3950 processor supported
- Dual external SIM card slot for WWAN connection
- 16-bit digital I/O
- One VGA; one HDMI supports resolutions up to 3840x2160 @ 30Hz
- Built-in GPS, OBD-II and J1939 functions
- SATA 6Gb/s SSD and mSATA module supported
- E-mark certification
- IP 4X rating protection
- Optional 802.11a/b/g/n/ac wireless connection

### 1.4 Front Panel

An overview of the front panel is shown in **Figure 1-2** below.

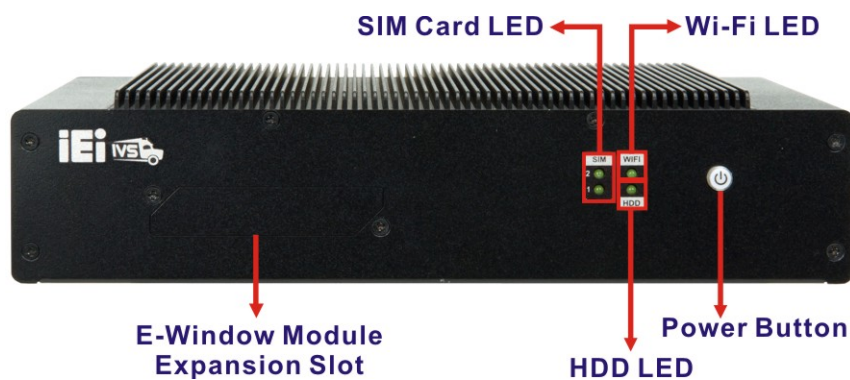

**Figure 1-2: Front Panel**

**1.4.1 LED Indicators**

The LED indicators on the front panel show the status of power, HDD, Wi-Fi and GPRS/HSUPA connection.

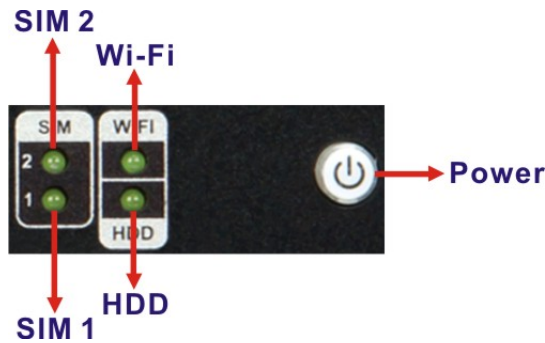

**Figure 1-3: LED Indicators**

<b>Power LED</b>	Amber	The system is off with power connected
	Blue	The system is turned on
	Blinking	At regular intervals: low voltage warning (configured by BIOS option: <b>Section 4.3.5</b> ) At irregular intervals (long-short-short): GPS antenna is not connected.
<b>SIM LED</b>	Off	The WWAN module is not installed or the SIM slot is not being used.
	Green	The WWAN module is installed and the SIM slot is being used for WWAN connection.
<b>Wi-Fi LED</b>	Off	The Wi-Fi module is not installed.
	Green	The Wi-Fi module is installed.
<b>HDD LED</b>	Off	HDD is not active
	Blinking	HDD is active

**Table 1-1: LED Indicators**



## IVS-110 Embedded System

### 1.5 Rear Panel

An overview of the rear panel is shown in **Figure 1-4**. Each I/O connector comes with a dust cover to keep it well protected from dust.

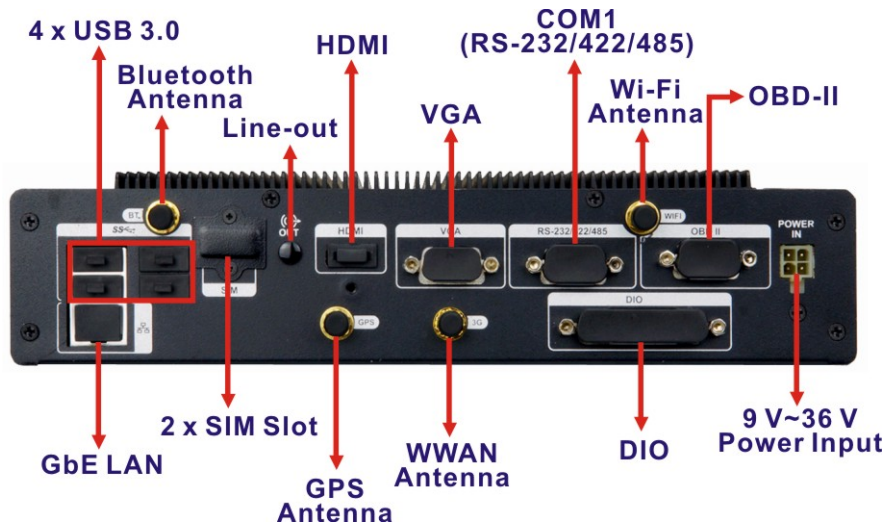
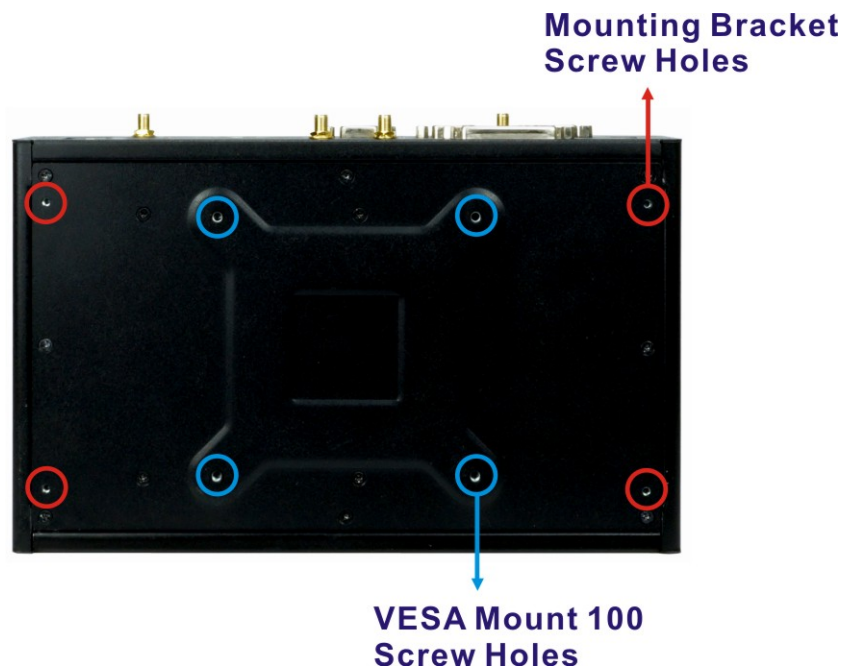

Figure 1-4: Rear Panel

## 1.6 Bottom Panel

The bottom panel of the IVS-110 contains several screw holes for VESA mount and wall mounting brackets. The bottom panel also provides access to the internal components, including SATA drive bay, mSATA slot and PCIe Mini card slots.



**Figure 1-5: Bottom Panel**

## IVS-110 Embedded System

### 1.7 Dimensions

The dimensions of the IVS-110 are listed below and shown in **Figure 1-6**.

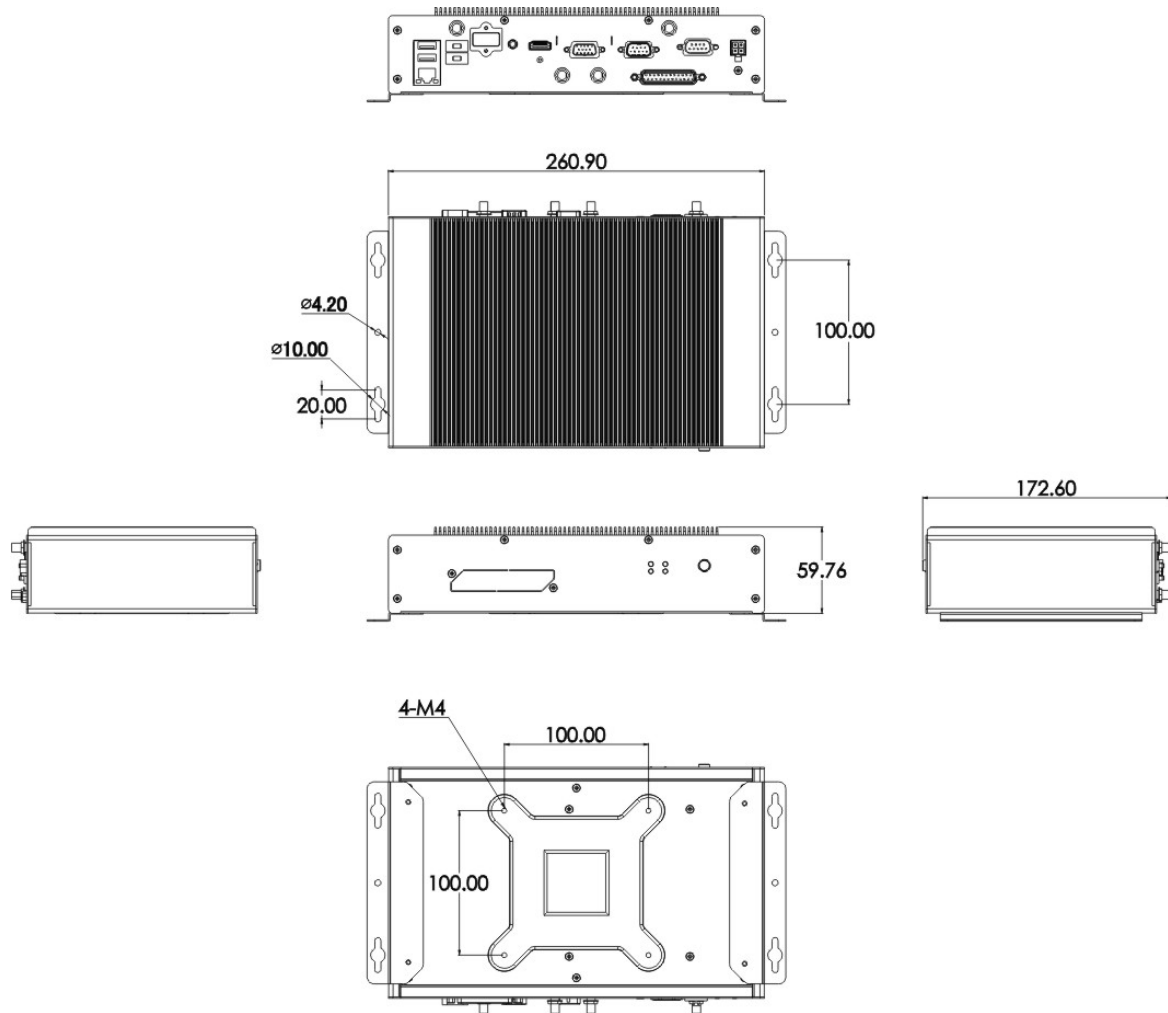

Figure 1-6: Dimensions (mm)

## 1.8 Technical Specifications

The specifications for the Intel based embedded systems are listed below.

	<b>IVS-110-AL-E3/4G</b>
<b>CPU (SoC)</b>	Intel® Atom® x7-E3950 (quad-core, 2.0 GHz, 12W TDP)
<b>System Memory</b>	1 x 204-pin DDR3L SO-DIMM slot Preinstalled 4 GB DDR3L SDRAM SO-DIMM
<b>Ethernet</b>	1 x RJ-45 PCIe GbE by Intel® I211
<b>GPS</b>	On-board GPS
<b>Wireless LAN</b>	PCIe Mini Wi-Fi 802.11 a/b/g/n/ac (optional)
<b>WWAN</b>	PCIe Mini WCDMA/HSDPA/HSUPA (optional) 2 x SIM card slot
<b>Bluetooth</b>	Bluetooth 4.0/3.0 + HS (optional, combo with WLAN module)
<b>Storage</b>	1 x 2.5" SATA 6Gb/s HDD/SSD bay 1 x eMMC 5.0 8GB (reserved) 1 x mSATA module slot
<b>Serial Port</b>	1 x RS-232/422/485 (configured by BIOS)
<b>Digital I/O</b>	1 x 16-bit digital I/O, 8-bit input/8-bit output
<b>Display</b>	1 x VGA port (up to 1920x1200 @ 60 Hz) 1 x HDMI port (up to 3840x2160 @ 30Hz)
<b>OBD-II/J1939</b>	1 x DB-9 OBD-II/J1939 connector
<b>Audio</b>	1 x Audio line-out
<b>USB</b>	4 x USB 3.0 port

## IVS-110 Embedded System

<b>Expansion Slot</b>	<p>1 x Full/Half-size PCIe Mini slot (reserved for WWAN)</p> <p>1 x Full/Half-size PCIe Mini slot (reserved for mSATA or IEI E-Window module)</p> <p>1 x Half-size PCIe Mini slot (reserved for WLAN)</p>
<b>Indicators</b>	<p>2 x SIM LED</p> <p>1 x HDD LED</p> <p>1 x Radio frequency LED</p>
<b>Chassis Construction</b>	Extruded aluminum alloy
<b>Thermal Design</b>	Fanless
<b>Power Input</b>	9 V – 36 V ( $\pm 0.3$ V) DC
<b>Power Consumption</b>	9 V @ 6.41 A; 36 V @ 1.19 A
<b>Operating Shock</b>	50 Grms, Half-sine 11 ms duration (with SSD, according to IEC60068-2-27)
<b>Operating Vibration</b>	5 Grms, 5-500 Hz, 3 axes (with SSD, according to IEC60068-2-64) MIL-STD-810F 514.5C-2 (with SSD)
<b>Operating Temperature</b>	-30°C – 70°C with air flow
<b>Storage Temperature</b>	-40°C – 80°C
<b>Humidity</b>	10% – 95%, non-condensing
<b>Mounting</b>	VESA 100
<b>Weight (Net/Gross)</b>	2.3 kg/3.6 kg
<b>Dimensions (W x D x H)</b>	261 mm x 170 mm x 60 mm
<b>EMC</b>	FCC, CE, E-Mark
<b>Supported OS</b>	Microsoft Windows 10 IoT Enterprise

**Table 1-2: Technical Specifications**



Chapter

**2**

# Unpacking

---

## IVS-110 Embedded System

### 2.1 Unpacking

To unpack the embedded system, follow the steps below:

- Step 1:** Use box cutters, a knife or a sharp pair of scissors that seals the top side of the external (second) box.
- Step 2:** Open the external (second) box.
- Step 3:** Use box cutters, a knife or a sharp pair of scissors that seals the top side of the internal (first) box.
- Step 4:** Lift the system out of the boxes.
- Step 5:** Remove both polystyrene ends, one from each side.
- Step 6:** Make sure all the components listed in the packing list are present.

### 2.2 Packing List



#### NOTE:

If any of the components listed in the checklist below are missing, do not proceed with the installation. Contact the IEI reseller or vendor the IVS-110 was purchased from or contact an IEI sales representative directly by sending an email to [sales@ieiworld.com](mailto:sales@ieiworld.com).

The IVS-110 embedded system is shipped with the following components:



Quantity	Item	Image
1	IVS-110 embedded system	

2	Mounting brackets	
4	Screws (M3*8) for mounting brackets	
4	Screws (M4*5) for VESA mounting	
4	Screws (M3*5) for SSD installation	
5	Screws (M2*3) for PCIe module installation	

**Table 2-1: Package List**

### 2.3 Optional Items

The following are optional component(s) which may be separately purchased:

Power adapter with transfer cable (P/N: IVIPOWER-4PIN-R10)	
Cigarette lighter power cable (P/N: 32002-004000-100-RS)	
ACC power cable (P/N: 32002-001900-100-RS)	

**IVS-110 Embedded System**

<p>OBD-II cable (P/N: 32025-003400-100-RS)</p>	
<p>Wi-Fi kit with AW-CB161H 802.11a/b/g/n/ac and Bluetooth 4.0 combo module (P/N: IVS-WIFI-KIT02-R10)</p>	
<p>WWAN kit (P/N: IVS-3G-KIT02-R10)</p>	
<p>GPS/LTE antenna (supports 2G/3G/4G) (P/N: 32506-000400-100-RS)</p>	

**Table 2-2: Optional Items**

Chapter

**3**

# Installation

---



## IVS-110 Embedded System

### 3.1 Anti-static Precautions

---



#### **WARNING:**

Failure to take ESD precautions during the maintenance of the IVS-110 may result in permanent damage to the IVS-110 and severe injury to the user.

---

Electrostatic discharge (ESD) can cause serious damage to electronic components, including the WAFER series motherboard and the power module. (Dry climates are especially susceptible to ESD.) It is therefore critical that whenever the IVS-110 is opened and any electrical component handled, the following anti-static precautions are strictly adhered to.

- **Wear an anti-static wristband:** Wearing a simple anti-static wristband can help to prevent ESD from damaging the board.
- **Self-grounding:** Before handling the board, touch any grounded conducting material. During the time the board is handled, frequently touch any conducting materials that are connected to the ground.
- **Use an anti-static pad:** When configuring the IVS-110, place it on an anti-static pad. This reduces the possibility of ESD damaging the IVS-110.

### 3.2 Installation Precautions

During installation, be aware of the precautions below:

- **Read the user manual:** The user manual provides a complete description of the IVS-110, installation instructions and configuration options.
- **DANGER! Disconnect Power:** Power to the IVS-110 must be disconnected during the installation process. Failing to disconnect the power may cause severe injury to the body and/or damage to the system.
- **Qualified Personnel:** The IVS-110 must be installed and operated only by trained and qualified personnel. Maintenance, upgrades, or repairs may only

be carried out by qualified personnel who are familiar with the associated dangers.

- **Air Circulation:** Make sure there is sufficient air circulation when installing the IVS-110. The IVS-110's cooling vents must not be obstructed by any objects. Blocking the vents can cause overheating of the IVS-110. Leave at least 5 cm of clearance around the IVS-110 to prevent overheating.
- **Grounding:** The IVS-110 should be properly grounded. The voltage feeds must not be overloaded. Adjust the cabling and provide external overcharge protection per the electrical values indicated on the label attached to the back of the IVS-110.

### 3.2.1 High Surface Temperature

---



#### **WARNING:**

Some surfaces of the equipment may become hot during operation.

The surface temperature may be up to several tens of degrees hotter than the ambient temperature. Under these circumstances, the equipment needs to be protected against accidental contact.

---

The equipment is intended for installation in a RESTRICTED ACCESS LOCATION.

- Access can only be gained by SERVICE PERSONS or by USERS who have been instructed about the reasons for the restrictions applied to the location and about any precautions that shall be taken.
- Access is through the use of a TOOL or lock and key, or other means of security, and is controlled by the authority responsible for the location.

## 3.3 Installation Procedure

To properly install the IVS-110, the following steps must be followed. Detailed descriptions of these instructions are listed in the sections that follow.

**Step 1:** Unpacking the IVS-110 embedded system

## IVS-110 Embedded System

**Step 2:** Install WLAN/WWAN module and SIM card (optional)

**Step 3:** Install mSATA module or SATA SSD

**Step 4:** Mount the IVS-110

**Step 5:** Connect the peripheral devices

**Step 6:** Power the system up

### 3.4 Open the Bottom Cover

---



#### **WARNING:**

1. Never open the system cover while power is still being fed into the system. Before opening the system, make sure the system has been turned off and all power connectors unplugged.
  2. Over-tightening bottom cover screws will cause damage to the bottom surface. Maximum torque for cover screws is 5 kg-cm (0.36 lb-ft/0.49 Nm).
- 

Before the internal component can be installed, the bottom cover must be removed to access the main board. To remove the back cover, please follow the steps below:

**Step 1:** Turn the IVS-110 over.

**Step 2:** Remove the bottom panel retention screws to detach the bottom panel from the chassis (**Figure 3-1**).

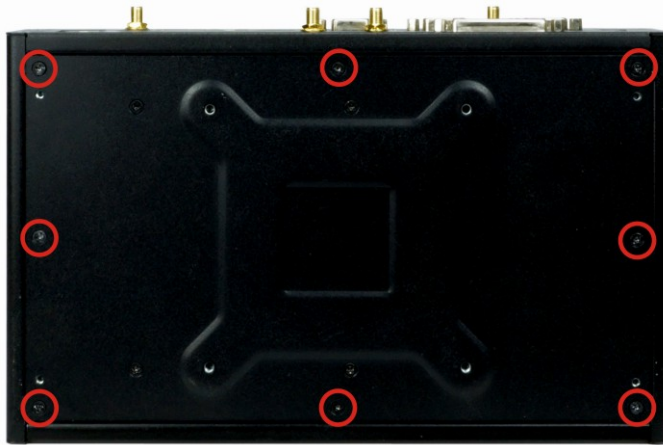

**Figure 3-1: Bottom Panel Retention Screws**

**Step 3:** Lift and carefully remove the bottom cover. Please be noted that a bracket for installing SSD is attached on the inside of the bottom cover. Be careful when removing the bottom cover.

### 3.5 PCIe Mini / mSATA Card Installation

The PCIe Mini slot allows installation of either a full-size or half-size PCIe Mini card. To install a full-size PCIe Mini card, an mSATA module or an E-Window module, please follow the steps below.

**Step 1:** Open the bottom cover. See **Section 3.4**.

**Step 2:** Locate the PCIe Mini slot for mSATA module as shown in **Figure 3-2**.



## IVS-110 Embedded System

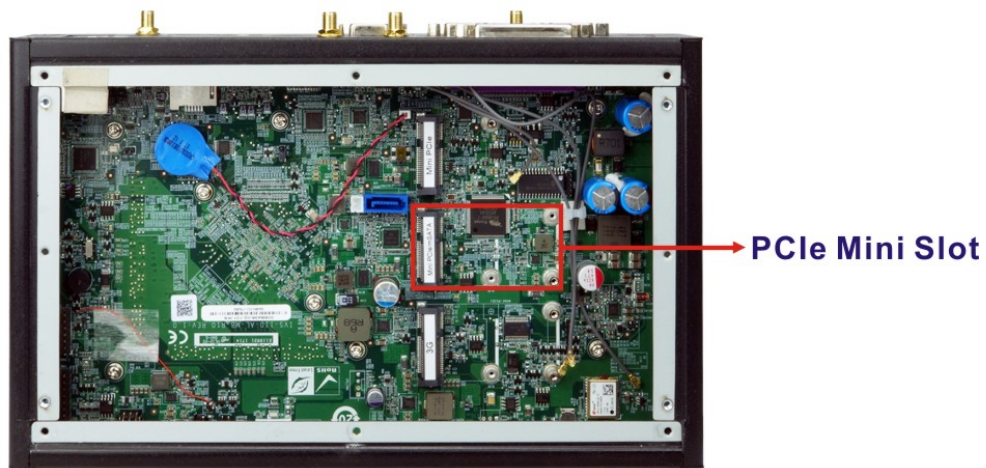

Figure 3-2: PCIe Mini Slot Location

**Step 3:** Line up the notch on the card with the notch on the slot. Slide the PCIe Mini card into the socket at an angle of about 20° (Figure 3-3).

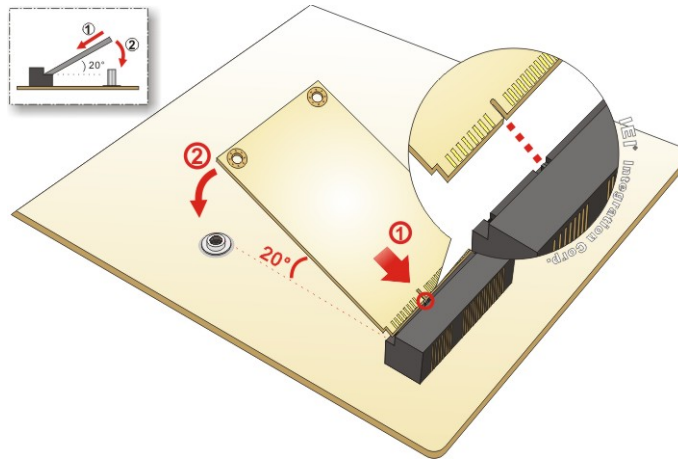
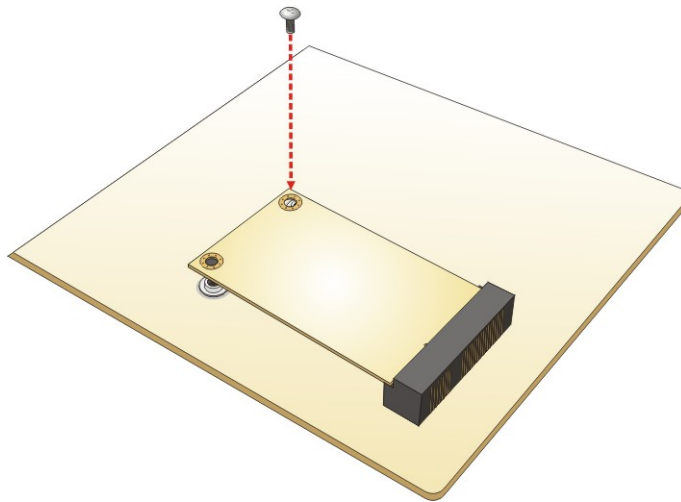

Figure 3-3: Inserting the Full-size PCIe Mini Card into the Slot at an Angle

**Step 4:** Secure the full-size PCIe Mini card with the M2\*3 screw shipped with the IVS-110 (Figure 3-4).





**Figure 3-4: Securing the Full-size PCIe Mini Card**

### 3.5.1 mSATA/E-Window Module Slot (MINI-PCIE3) Pinouts

The pinouts for the mSATA/E-Window module slot (MINI-PCIE3) are listed in the table below.

PIN NO.	DESCRIPTION	PIN NO.	DESCRIPTION
1	WAKE#	2	VCC3
3	NC	4	GND
5	NC	6	VCC1.5
7	PCIE_CLKREQ_N	8	NC
9	GND	10	NC
11	CLK_PCIE_CLK_N	12	NC
13	CLK_PCIE_CLK_P	14	NC
15	GND	16	NC
17	NC	18	GND
19	NC	20	WIFI1_ON
21	GND	22	PCIRST#
23	PCIE_RXN	24	VCC3
25	PCIE_RXP	26	GND
27	GND	28	VCC1.5
29	GND	30	SMB_CLK

IVS-110 Embedded System

31	PCIE_TXN	32	SMB_DATA
33	PCIE_TXP	34	GND
35	GND	36	USB_DATA_N
37	NC	38	USB_DATA_P
39	VCC3	40	GND
41	VCC3	42	NC
43	NC	44	NC
45	NC	46	NC
47	NC	48	VCC1.5
49	NC	50	GND
51	SATADET#	52	VCC3

Table 3-1: mSATA/E-Window Module Slot (MINI-PCIE3) Pinouts

### 3.6 WLAN/WWAN Module Installation

To install the optional WLAN or WWAN module, please follow the steps below.

**Step 1:** Open the bottom cover. See **Section 3.4**.

**Step 2:** Locate the half-size PCIe Mini slot for WLAN modules and the full-size PCIe Mini slot for WWAN modules (**Figure 3-5**).

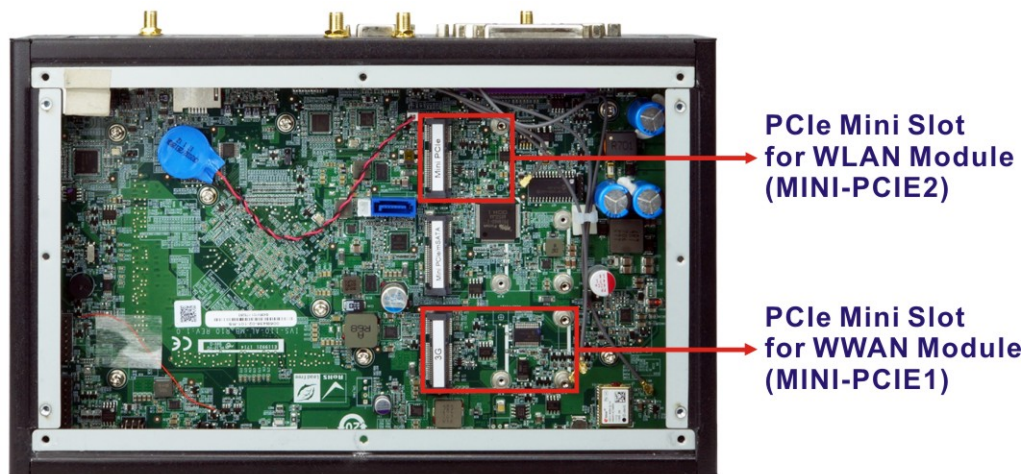
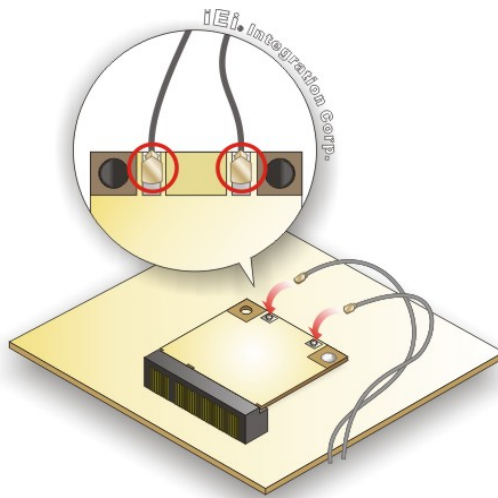

Figure 3-5: WLAN and WWAN Card Slot Locations

- Step 3:** Line up the notch on the WLAN/WWAN module with the notch on the slot. Slide the WLAN/WWAN module into the slot at an angle of about 20°.
- Step 4:** Secure the WLAN/WWAN module with the M2\*3 screw shipped with the IVS-110.
- Step 5:** Connect the RF cable(s) from the system to the antenna connector(s) on the WLAN/WWAN module (**Figure 3-6**).



**Figure 3-6: Connecting RF Cables**

### 3.6.1 WWAN Module Slot (MINI-PCIE1) Pinouts

The pinouts for the WWAN module slot (MINI-PCIE1) are listed in the table below.

PIN NO.	DESCRIPTION	PIN NO.	DESCRIPTION
1	NC	2	VCC3
3	NC	4	GND
5	NC	6	VCC1.5
7	NC	8	SIM_VCC
9	GND	10	SIM_CIO
11	NC	12	SIM_CLK
13	NC	14	SIM_RST
15	GND	16	NC

## IVS-110 Embedded System

17	NC	18	GND
19	NC	20	HSUPA_ON
21	GND	22	NC
23	NC	24	VCC3
25	NC	26	GND
27	GND	28	VCC1.5
29	GND	30	NC
31	NC	32	NC
33	NC	34	GND
35	GND	36	USB_DATA_N
37	NC	38	USB_DATA_P
39	VCC3	40	GND
41	VCC3	42	NC
43	3GLED_EN	44	NC
45	NC	46	NC
47	NC	48	VCC1.5
49	NC	50	GND
51	NC	52	VCC3

**Table 3-2: WWAN Module Slot (MINI-PCIE1) Pinouts**

### 3.6.2 WLAN Module Slot (MINI-PCIE2) Pinouts

The pinouts for the WLAN module slot (MINI-PCIE2) are listed in the table below.

PIN NO.	DESCRIPTION	PIN NO.	DESCRIPTION
1	WAKE#	2	VCC3
3	NC	4	GND
5	NC	6	VCC1.5
7	NC	8	NC
9	GND	10	NC
11	CLK_PCIE_CLK_N	12	NC
13	CLK_PCIE_CLK_P	14	NC
15	GND	16	NC
17	NC	18	GND



19	NC	20	WIFI_ON
21	WIFI_LED1	22	PCIRST#
23	PCIE_RXN	24	VCC3
25	PCIE_RXP	26	GND
27	GND	28	VCC1.5
29	GND	30	SMB_CLK
31	PCIE_TXN	32	SMB_DATA
33	PCIE_TXP	34	GND
35	GND	36	USB_DATA_N
37	NC	38	USB_DATA_P
39	NC	40	GND
41	NC	42	WIFI_LED3
43	NC	44	WIFI_LED2
45	NC	46	NC
47	NC	48	VCC1.5
49	NC	50	GND
51	NC	52	VCC3

**Table 3-3: WLAN Module Slot (MINI-PCIE2) Pinouts**

### 3.7 SIM Card Installation

To be able to use the WWAN network connection, SIM cards must be installed in the IVS-110. Follow the steps below to install SIM cards.

**Step 1:** Install a WWAN module into the IVS-110. See **Section 3.6**.

**Step 2:** Remove the two retention screws (**Figure 3-7**) to detach the SIM slot cover.

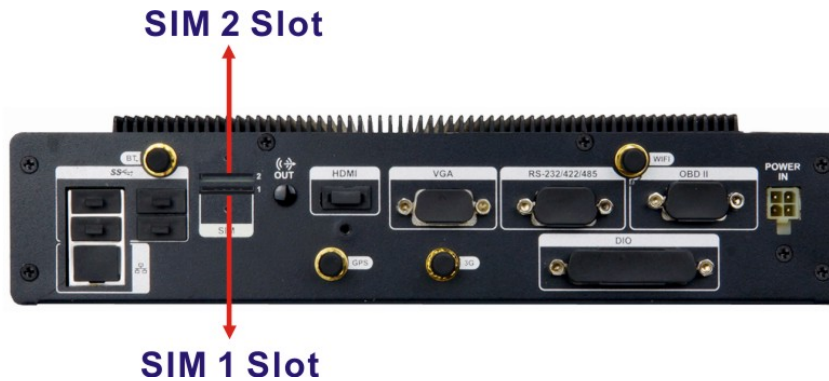

**Figure 3-7: SIM Card Slot Cover Retention Screws**



## IVS-110 Embedded System

**Step 3:** Locate the SIM card slots on the rear panel (**Figure 3-8**).



**Figure 3-8: SIM Card Slot Locations**

- Step 4:** Insert a SIM card into the SIM 1 slot with the gold contacts facing down. Insert a SIM card into the SIM 2 slot with the gold contacts facing up. To remove the SIM card, push the SIM card to release it.
- Step 5:** Install IEI Mobile AP to designate a SIM card to use. The Mobile AP instruction is described in detail in **Section 3.13**.
- Step 6:** The SIM LED indicators on the front panel show the user which SIM card is being used. See **Section 1.4.1**.

### 3.8 Solid-State Drive Installation

One 2.5" SATA SSD can be installed in the IVS-110. The SATA SSD is installed into a hard drive bracket attached on the inside of the bottom surface. To install the SSD into the system, please follow the steps below.

**Step 1:** Open the bottom cover. See **Section 3.4**.

**Step 2:** The SSD bracket for installing SSD is located on the internal side of the bottom cover. Remove the four screws shown below to remove the SSD bracket.

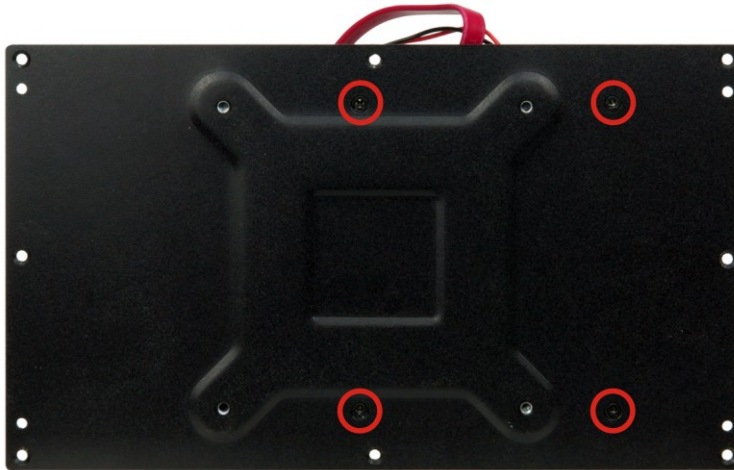
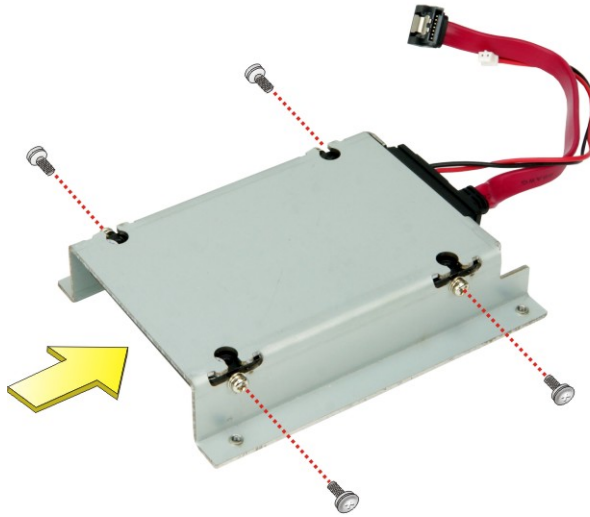

**Figure 3-9: SSD Bracket Retention Screws**

**Step 3:** Insert a SSD into the bracket until the SSD is firmly connected to the SATA interface on the bracket.

**Step 4:** Align the retention screw holes in the SSD with those in both sides of the bracket. Secure the SSD with the bracket by inserting four retention screws (M3\*5) into the sides of the bracket (**Figure 3-10**).

## IVS-110 Embedded System



**Figure 3-10: SSD Retention Screws**

- Step 5:** Connect the SATA cable to the SATA connector and SATA power connector on the motherboard.
- Step 6:** Re-install the SSD bracket onto the bottom surface by aligning the four retention screw holes in the SSD bracket to the four screw holes on the bottom surface and securing with the four previously removed retention screws.
- Step 7:** Re-install the bottom cover.

### 3.9 Mounting the System

To mount the embedded system onto a wall or some other surface using the two mounting brackets, please follow the steps below.

- Step 1:** Turn the embedded system over.
- Step 2:** Align the two retention screw holes in each bracket with the retention screw holes on the sides of the bottom surface.
- Step 3:** Secure the brackets to the system by inserting two retention screws (M3\*8) into each bracket (**Figure 3-11**).

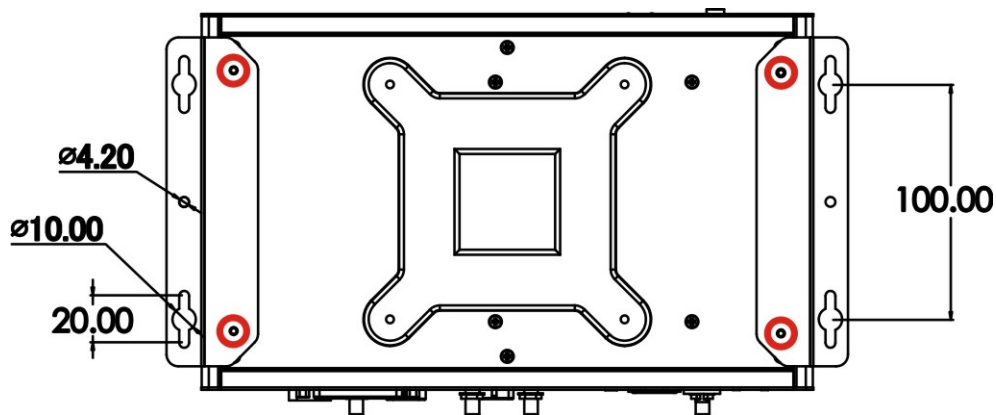

**Figure 3-11: Mounting Bracket Retention Screws**

- Step 4:** Drill holes in the intended installation surface.
- Step 5:** Align the mounting holes in the sides of the mounting brackets with the predrilled holes in the mounting surface.
- Step 6:** Insert four retention screws, two in each bracket, to secure the system to the wall.

## IVS-110 Embedded System

### 3.9.1 VESA Mount

The IVS-110 is VESA (Video Electronics Standards Association) compliant and can be mounted on a mounting device with a 100 mm interface pad. The IVS-110 VESA mount retention screw holes are shown in **Figure 3-12**. Refer to the installation guide that came with the mounting device to mount the IVS-110.

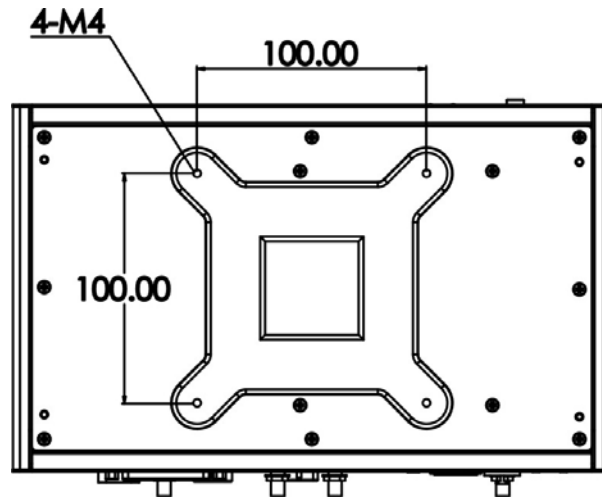

Figure 3-12: VESA Mounting Retention Screw Holes



#### NOTE:

When purchasing the mounting device, please ensure that it is VESA compliant and that the device has a 100 mm interface pad. If the mounting device is not VESA compliant, it cannot be used to support the IVS-110 embedded system.



### 3.10 External I/O Connectors

This section provides an overview of the external I/O connectors of the IVS-110.

#### 3.10.1 COM Port Connection

The IVS-110 has one DB-9 connectors for RS-232/422/485 serial port connection. The pinouts for the RS-232/422/485 connector (COM1) are listed in the figure and table below. The RS-232/422/485 mode can be configured through BIOS; the default setting is RS-232 mode (refer to **Section 4.3.3.1.1**).

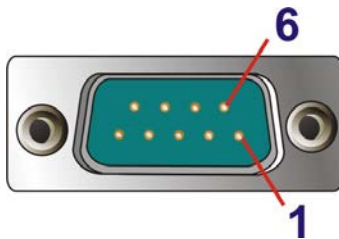

**Figure 3-13: RS-232/422/485 Connector (COM1)**

PIN NO.	RS-232	RS-422	RS-485
1	DCD	TX-	TX-
2	RX	TX+	TX+
3	TX	RX+	
4	DTR	RX-	
5	GND		
6	DSR		
7	RTS		
8	CTS		
9	RI		

**Table 3-4: RS-232/422/485 Connector Pinouts**

## IVS-110 Embedded System

### 3.10.2 DIO Connection

The IVS-110 has one DB-25 connector for DIO connection. The pinouts for the DIO connector are listed in the figure and table below.

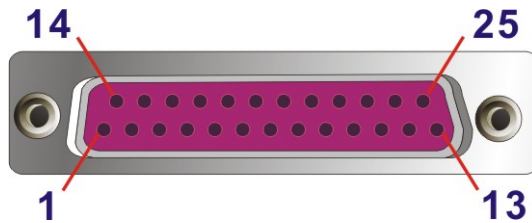

Figure 3-14: DIO Connector

PIN NO.	DESCRIPTION	PIN NO.	DESCRIPTION
1	DIN0	14	DOUT0
2	DIN1	15	DOUT1
3	DIN2	16	DOUT2
4	DIN3	17	DOUT3
5	DIN4	18	DOUT4
6	DIN5	19	DOUT5
7	DIN6	20	DOUT6
8	DIN7	21	DOUT7
9	+5V	22	GND
10	NC	23	NC
11	NC	24	NC
12	NC	25	NC
13	NC		

Table 3-5: DIO Connector Pinouts

**3.10.3 OBD-II Connection**

The IVS-110 has one DB-9 connector for OBD-II/J1939 connection. The pinouts for the OBD-II connector are listed in the figure and table below.

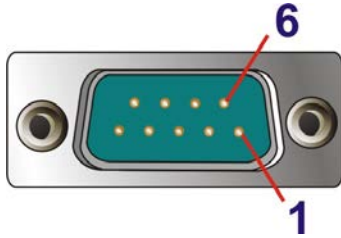

**Figure 3-15: OBD-II Connector**

PIN NO.	DESCRIPTION
1	GND
2	GND
3	OBD-CAN_H
4	ISO-9141-2-K
5	OBD-CAN_L
6	J1850-
7	J1850+
8	ISO-9141-2-L
9	NC

**Table 3-6: OBD-II Connector Pinouts**

## IVS-110 Embedded System

### [Optional Choice]

The OBD-II cable (**Figure 3-16**) can be purchased separately. The user can use the cable to connect the IVS-110 with the vehicle. The pinout locations of OBD-II cable connector are also shown below.



Figure 3-16: OBD-II Cable and Connector Pinouts

## 3.11 Power-On Procedure

### 3.11.1 Installation Checklist



#### **WARNING:**

Make sure a power supply with the correct input voltage is being fed into the system. Incorrect voltages applied to the system may cause damage to the internal electronic components and may also cause injury to the user.

---

To power on the embedded system please make sure of the following:

- The bottom cover is installed
- All peripheral devices (monitors, serial communications devices etc.) are connected
- The power cables are plugged in
- The system is securely mounted

### 3.11.2 Power Input Connection

The IVS-110 has a 9 V – 36 V power input connector. The 4-pin power connector pinouts are listed in the figure and table below.

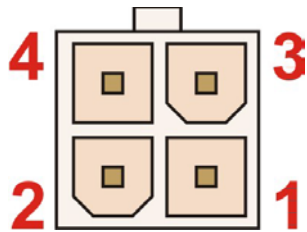

**Figure 3-17: Power Input Connector**

PIN NO.	DESCRIPTION
1	GND
2	GND
3	9V~36V
4	ACC

**Table 3-7: Power Input Connector Pinouts**

#### [Optional Choice]

The IVS-110 can use either ACC power or DC power from the vehicle. To use ACC power, connect the IVS-110 to the vehicle through the ACC power cable. See **Figure 3-18**.



**Figure 3-18: ACC Power Cable**



## IVS-110 Embedded System

To use DC power, connect the IVS-110 to the vehicle cigarette lighter connector through the optional cigarette lighter cable or to the power adapter through the transfer cable. See **Figure 3-19** and **Figure 3-20**.



**Figure 3-19: Optional Cigarette Lighter Cable**



**Figure 3-20: Optional Power Adapter and Transfer Cable**

### 3.11.3 Power-on Procedure

To power-on the IVS-110 please follow the steps below:

- Step 1:** Connect the power source to the power connector to the system by using the cables mentioned above.
- Step 2:** Push the power button for several seconds until the power LED turns from amber to blue (**Figure 3-21**).

**Power Button with LED**



**Figure 3-21: Power Button**

### 3.12 Driver Installation

All the drivers for the IVS-110 are available on IEI Resource Download Center (<https://download.ieiworld.com>). Type IVS-110 and press Enter to find all the relevant software, utilities, and documentation.



**Figure 3-22: IEI Resource Download Center**

IEI provides the following drivers for Windows 10 operating systems.

- Chipset
- Graphics
- Audio
- LAN
- WLAN (including Bluetooth driver, WWAN module driver, WLAN module driver and IEI Mobile AP application tool)

## IVS-110 Embedded System

- Others:
  - TXE
  - I/O driver



### NOTE:

To install software from the downloaded ISO image file in Windows 10, double-click the ISO file to mount it as a virtual drive to view its content.

---

## 3.13 Mobile AP

IEI provides an application tool, Mobile AP, for the users of the IVS-110 with the WWAN module installed to manage mobile network and make a phone call.

### 3.13.1 Installation

To install this application tool, please locate the **WLAN** folder in the utility CD. This folder contains two files for different operating systems.

- **IEI\_Mobile\_AP\_Setup\_x86\_vxx.exe** for 32-bit Windows OS
- **IEI\_Mobile\_AP\_Setup\_x64\_vxx.exe** for 64-bit Windows OS

Double click the .exe file that is corresponding to the OS version, then the system starts to extract the file. After extracting, it starts to install the Bluetooth driver followed by the installation of the WWAN module driver, and IEI Mobile AP application tool. It is recommended to follow the step-by-step procedure to install all of these three drivers/applications.



### NOTE:

After installing the drivers and applications, the IVS-110 must be restarted in order to complete the installation.

---

### 3.13.2 Usage

To launch the application, double click the **MobileAP** icon on the Windows desktop. The user interface appears as shown in **Figure 3-23**. The functions are described below.

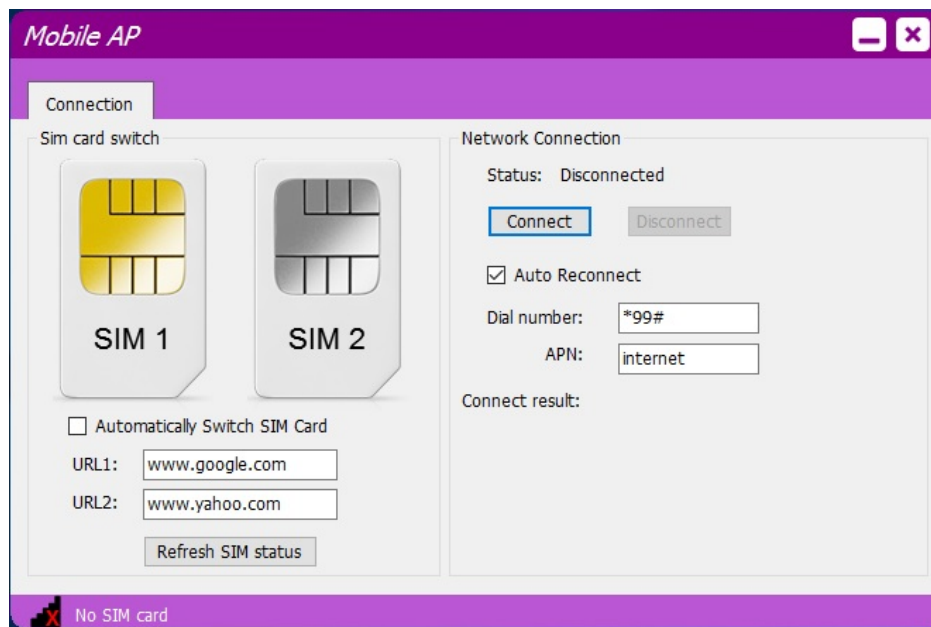

**Figure 3-23: Mobile AP – Connection**

- **Sim card switch:**
  - Select a SIM card to designate a SIM card to use or click the **Refresh SIM status** button to let the system detect automatically.
  - **Automatically Switch SIM Card:** check to allow the system to ping URL1 and URL2 every 30 seconds. If the system is unable to ping both URLs in three minutes, the system will automatically switch to the other SIM card.
- **Network Connection:**
  - **Status:** shows the connection status. Click the **Connect** button to connect the selected SIM card to network.
  - **Auto Reconnect:** allows the system to reconnect automatically.
  - **Dial number:** provided by the ISP for mobile network. The default value is **\*99#**.
  - **APN (Access Point Name):** provided by the ISP for mobile network. The default value is **internet**.
  - **Connect result:** displays the connection result.

Chapter

4

**BIOS**

---



## 4.1 Introduction

The BIOS is programmed onto the BIOS chip. The BIOS setup program allows changes to certain system settings. This chapter outlines the options that can be changed.



### NOTE:

Some of the BIOS options may vary throughout the life cycle of the product and are subject to change without prior notice.

---

### 4.1.1 Starting Setup

The UEFI BIOS is activated when the computer is turned on. The setup program can be activated in one of two ways.

1. Press the **DELETE** key as soon as the system is turned on or
2. Press the **DELETE** key when the “**Press Delete to enter SETUP**” message appears on the screen.

If the message disappears before the **DELETE** key is pressed, restart the computer and try again.

### 4.1.2 Using Setup

Use the arrow keys to highlight items, press **ENTER** to select, use the PageUp and PageDown keys to change entries, press **F1** for help and press **ESC** to quit. Navigation keys are shown in.

Key	Function
Up arrow	Move to the item above
Down arrow	Move to the item below
Left arrow	Move to the item on the left hand side
Right arrow	Move to the item on the right hand side
+	Increase the numeric value or make changes

## IVS-110 Embedded System

Key	Function
-	Decrease the numeric value or make changes
Page up	Move to the next page
Page down	Move to the previous page
Esc	Main Menu – Quit and do not save changes into CMOS Status Page Setup Menu and Option Page Setup Menu -- Exit current page and return to Main Menu
F1 key	General help, only for Status Page Setup Menu and Option Page Setup Menu
F2 key	Load previous values
F3 key	Load optimized defaults
F4 key	Save changes and Exit BIOS

**Table 4-1: BIOS Navigation Keys**

### 4.1.3 Getting Help

When **F1** is pressed a small help window describing the appropriate keys to use and the possible selections for the highlighted item appears. To exit the Help Window press **Esc** or the **F1** key again.

### 4.1.4 BIOS Menu Bar

The **menu bar** on top of the BIOS screen has the following main items:

- Main – Changes the basic system configuration.
- Advanced – Changes the advanced system settings.
- Chipset – Changes the chipset settings.
- Security – Sets User and Supervisor Passwords.
- Boot – Changes the system boot configuration.
- Save & Exit – Selects exit options and loads default settings

The following sections completely describe the configuration options found in the menu items at the top of the BIOS screen and listed above.

## 4.2 Main

The **Main** BIOS menu (**BIOS Menu 1**) appears when the **BIOS Setup** program is entered.

The **Main** menu gives an overview of the basic system information.

```

Aptio Setup Utility - Copyright (C) 2017 American Megatrends, Inc.
Main  Advanced  Chipset  Security  Boot  Save & Exit

BIOS Information
BIOS Vendor                American Megatrends
Core Version                5.12
Compliance                 UEFI 2.5; PI 1.4
Project Version            Z418AT07.ROM
Build Date and Time        10/03/2017 14:46:07

Platform firmware Information
BXT SOC                    B1
MRC Version                0.56
PUNIT FW                  28
PMC FW                    03.38
TXE FW                    3.0.12.1138
ISH FW                    4.1.0.3364
GOP                        0.0.0036

Memory Information
Total Memory               4096 MB
Memory Speed               1600 MHz

Access Level                Administrator

System Date                 [Mon 08/17/2015]
System Time                 [11:10:27]

Set the Date. Use Tab to
switch between Data
elements.

-----
-><: Select Screen
↑↓: Select Item
Enter: Select
+/-: Change Opt.
F1: General Help
F2: Previous Values
F3: Optimized Defaults
F4: Save & Exit
ESC: Exit

Version 2.18.1263. Copyright (C) 2017 American Megatrends, Inc.
  
```

### BIOS Menu 1: Main

The **Main** menu has two user configurable fields:

➔ **System Date [xx/xx/xx]**

Use the **System Date** option to set the system date. Manually enter the day, month and year.

➔ **System Time [xx:xx:xx]**

Use the **System Time** option to set the system time. Manually enter the hours, minutes and seconds.

## IVS-110 Embedded System

### 4.3 Advanced

Use the **Advanced** menu (**BIOS Menu 2**) to configure the CPU and peripheral devices through the following sub-menus:



#### **WARNING!**

Setting the wrong values in the sections below may cause the system to malfunction. Make sure that the settings made are compatible with the hardware.

```

Aptio Setup Utility - Copyright (C) 2017 American Megatrends, Inc.
Main  Advanced  Chipset  Security  Boot  Save & Exit

> Trusted Computing
> ACPI Settings
> F81866 Super IO Configuration
> F81866 Hardware Monitor
> Power Management
> USB Configuration
> CPU Configuration
> RTC Wake Settings
> Serial Port Console Redirection
> iEi Feature

System ACPI Parameters
-----
-><: Select Screen
↑ ↓: Select Item
Enter: Select
+/-: Change Opt.
F1: General Help
F2: Previous Values
F3: Optimized Defaults
F4: Save & Exit
ESC: Exit

Version 2.18.1263. Copyright (C) 2017 American Megatrends, Inc.
    
```

#### **BIOS Menu 2: Advanced**

### 4.3.1 Trusted Computing

Use the **Trusted Computing** menu (**BIOS Menu 3**) to configure settings related to the Trusted Computing Group (TCG) Trusted Platform Module (TPM).

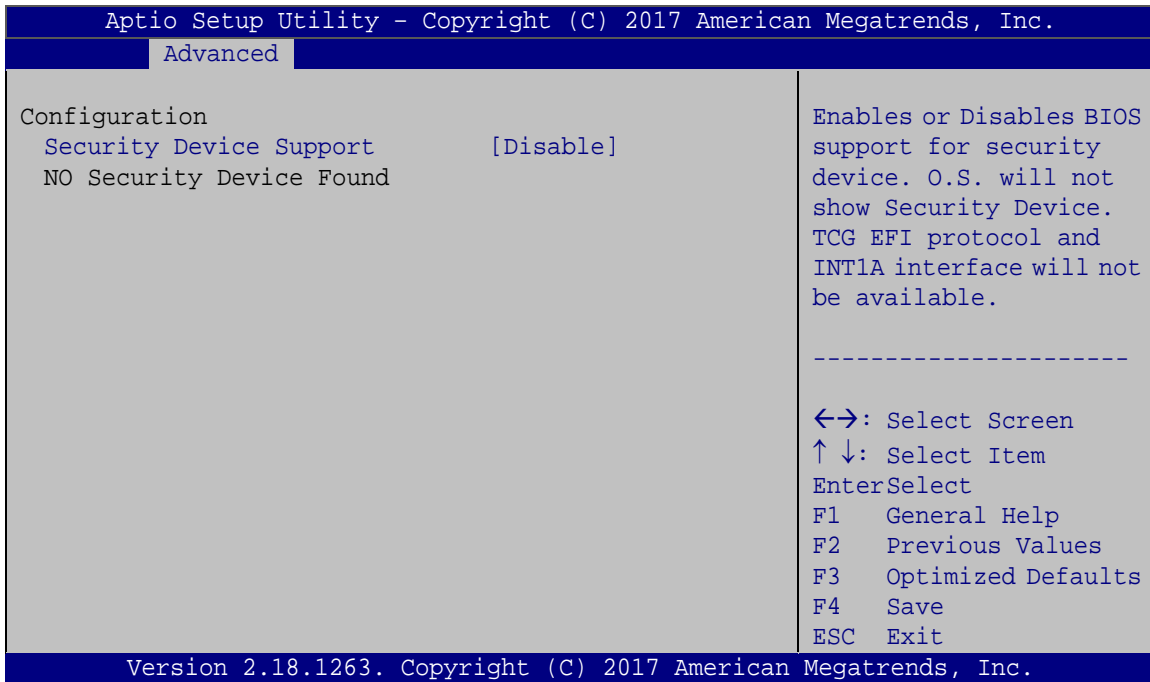

#### BIOS Menu 3: Trusted Computing

##### → Security Device Support [Disable]

Use the **Security Device Support** option to configure support for the security device.

- **Disable**      **DEFAULT**      Security device support is disabled.
- **Enable**        Security device support is enabled.



## IVS-110 Embedded System

### 4.3.2 ACPI Settings

The **ACPI Settings** menu (**BIOS Menu 4**) configures the Advanced Configuration and Power Interface (ACPI) options.

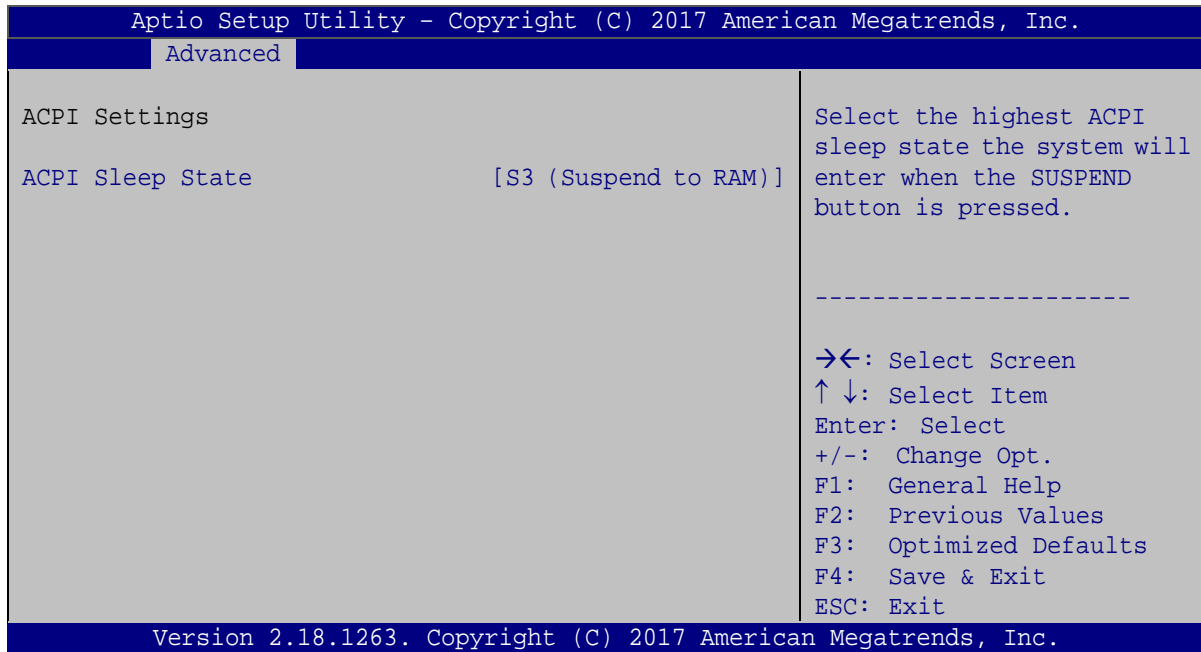

#### BIOS Menu 4: ACPI Settings

##### → ACPI Sleep State [S3 (Suspend to RAM)]

Use the **ACPI Sleep State** option to specify the sleep state the system enters when it is not being used.

- **S3 (Suspend to DEFAULT RAM)** The caches are flushed and the CPU is powered off. Power to the RAM is maintained. The computer returns slower to a working state, but more power is saved.

### 4.3.3 F81866 Super IO Configuration

Use the **F81866 Super IO Configuration** menu (**BIOS Menu 5**) to set or change the configurations for the serial ports.

```

Aptio Setup Utility - Copyright (C) 2017 American Megatrends, Inc.
  Advanced
F81866 Super IO Configuration                               Set Parameters of Serial
                                                           Port 1 (COMA)
Super IO Chip                                           F81866
> Serial Port 1 Configuration
> Serial Port 2 Configuration
> Serial Port 3 Configuration
> Serial Port 4 Configuration
                                                           -----
                                                           →←: Select Screen
                                                           ↑ ↓: Select Item
                                                           Enter: Select
                                                           +/-: Change Opt.
                                                           F1: General Help
                                                           F2: Previous Values
                                                           F3: Optimized Defaults
                                                           F4: Save & Exit
                                                           ESC: Exit
Version 2.18.1263. Copyright (C) 2017 American Megatrends, Inc.
    
```

**BIOS Menu 5: F81866 Super IO Configuration**

#### 4.3.3.1 Serial Port n Configuration

Use the **Serial Port n Configuration** menu (**BIOS Menu 6**) to configure the serial port n.

```

Aptio Setup Utility - Copyright (C) 2017 American Megatrends, Inc.
  Advanced
Serial Port n Configuration                               Enable or Disable Serial
                                                           Port (COM)
Serial Port                                           [Enabled]
Device Settings                                       IO=3F8h; IRQ=4
                                                           -----
Change Settings                                       [IO=3F8h; IRQ=4;]
Transfer Mode                                         [RS232]
                                                           -----
                                                           →←: Select Screen
                                                           ↑ ↓: Select Item
                                                           Enter: Select
                                                           +/-: Change Opt.
                                                           F1: General Help
                                                           F2: Previous Values
                                                           F3: Optimized Defaults
                                                           F4: Save & Exit
                                                           ESC: Exit
Version 2.18.1263. Copyright (C) 2017 American Megatrends, Inc.
    
```

**BIOS Menu 6: Serial Port n Configuration Menu**

#### 4.3.3.1.1 Serial Port 1 Configuration

##### → Serial Port [Enabled]

Use the **Serial Port** option to enable or disable the serial port.

- **Disabled**                      Disable the serial port
- **Enabled**      **DEFAULT**      Enable the serial port

##### → Change Settings [IO=3F8h; IRQ=4]

Use the **Change Settings** option to change the serial port IO port address and interrupt address.

- **IO=3F8h;      DEFAULT      Serial Port I/O port address is 3F8h and the interrupt  
IRQ=4**                      address is IRQ4
- **IO=3F8h;                      Serial Port I/O port address is 3F8h and the interrupt  
IRQ=3, 4,**                      address is IRQ3, 4
- **IO=2F8h;                      Serial Port I/O port address is 2F8h and the interrupt  
IRQ=3, 4**                      address is IRQ3, 4
- **IO=3E8h;                      Serial Port I/O port address is 3E8h and the interrupt  
IRQ=3, 4**                      address is IRQ3, 4
- **IO=2E8h;                      Serial Port I/O port address is 2E8h and the interrupt  
IRQ=3, 4**                      address is IRQ3, 4



## IVS-110 Embedded System

### 4.3.3.1.3 Serial Port 3 Configuration

#### → Serial Port [Enabled]

Use the **Serial Port** option to enable or disable the serial port.

- **Disabled**                      Disable the serial port
- **Enabled      DEFAULT**      Enable the serial port

#### → Change Settings [IO=3E8h; IRQ=10]

Use the **Change Settings** option to change the serial port IO port address and interrupt address.

- **IO=3E8h;      DEFAULT**      Serial Port I/O port address is 3E8h and the interrupt address is IRQ10  
**IRQ=10**
- **IO=2E8h;**                      Serial Port I/O port address is 2E8h and the interrupt address is IRQ10  
**IRQ=10**
- **IO=3E0h;**                      Serial Port I/O port address is 3E0h and the interrupt address is IRQ10  
**IRQ=10**
- **IO=2E0h;**                      Serial Port I/O port address is 2E0h and the interrupt address is IRQ10  
**IRQ=10**

### 4.3.3.1.4 Serial Port 4 Configuration

#### → Serial Port [Enabled]

Use the **Serial Port** option to enable or disable the serial port.

- **Disabled**                      Disable the serial port
- **Enabled      DEFAULT**      Enable the serial port

#### → Change Settings [IO=2E8h; IRQ=10]

Use the **Change Settings** option to change the serial port IO port address and interrupt address.





## IVS-110 Embedded System

- CPU Temperature
- System Temperature
- Fan Speed:
  - CPU Fan speed
- Voltages:
  - CPU\_CORE
  - +5V
  - +12V
  - +5VSB
  - +3.3V
  - +3.3VSB

### 4.3.4.1 Smart Fan Mode Configuration

Use the **Smart Fan Mode Configuration** submenu (**BIOS Menu 8**) to configure fan temperature and speed settings.

```

Aptio Setup Utility - Copyright (C) 2017 American Megatrends, Inc.
Advanced
Smart Fan Mode Configuration
CPU_FAN1 Smart Fan Control [Auto Duty-Cycle Mode]
CPU Temperature 1 60
CPU Temperature 2 50
CPU Temperature 3 40
CPU Temperature 4 30
Smart Fan Mode Select
-----
<->: Select Screen
↑ ↓: Select Item
Enter>Select
+ - Change Opt.
F1 General Help
F2 Previous Values
F3 Optimized Defaults
F4 Save & Exit
ESC Exit
Version 2.18.1263. Copyright (C) 2017 American Megatrends, Inc.

```

### BIOS Menu 8: Smart Fan Mode Configuration

**→ CPU\_FAN1 Smart Fan Control [Auto Duty-Cycle Mode]**

Use the **CPU\_FAN1 Smart Fan Control** BIOS option to configure the CPU Smart Fan.

**→ Manual Duty Mode**                      The fan spins at the speed set in the Manual Duty Mode option

**→ Auto Duty-Cycle Mode**              **DEFAULT**      The fan adjusts its speed using these settings:

CPU Temperature 1

CPU Temperature 2

CPU Temperature 3

CPU Temperature 4

**→ CPU Temperature 1**

If CPU temperature is higher than the value set in this BIOS option, the fan duty cycle is 100. Use the + or – key to change the value or enter a decimal number between 1 and 100.

**→ CPU Temperature 2**

If CPU temperature is higher than the value set in this BIOS option, the fan duty cycle is 85. Use the + or – key to change the value or enter a decimal number between 1 and 100.

**→ CPU Temperature 3**

If CPU temperature is higher than the value set in this BIOS option, the fan duty cycle is 70. Use the + or – key to change the value or enter a decimal number between 1 and 100.

**→ CPU Temperature 4**

If CPU temperature is higher than the value set in this BIOS option, the fan duty cycle is 60; if it is lower than the value, the fan duty cycle is 50. Use the + or – key to change the value or enter a decimal number between 1 and 100.

## IVS-110 Embedded System

### 4.3.5 Power Management

Use the **Power Management** menu (**BIOS Menu 9**) to configure the power management function.

```

Aptio Setup Utility - Copyright (C) 2017 American Megatrends, Inc.
  Advanced
Current Voltage           : +12.0 V
Low Voltage Warning      [9V]
Set Low Voltage Warning  (8V~37V)
*** Delay Time Setting ***
Auto Power On Delay      [10 sec]
Auto Power Off Delay     [20 sec]
-----
-><: Select Screen
↑↓: Select Item
Enter: Select
+/-: Change Opt.
F1: General Help
F2: Previous Values
F3: Optimized Defaults
F4: Save & Exit
ESC: Exit
Version 2.18.1263. Copyright (C) 2017 American Megatrends, Inc.

```

#### BIOS Menu 9: Power Management

##### → Low Voltage Warning [9V]

Use the **Low Voltage Warning** option to set the low voltage warning from 8V to 37V. If the system voltage is lower than the value set here, the power LED on the system front panel will blink at regular intervals (refer to **Section 1.4.1**) to warn users.

##### → Auto Power On Delay [10 sec]

Use the **Auto Power On Delay** option to set the automatic power-on delay time. Configuration options are listed below.

- 10 sec    **DEFAULT**
- 30 sec
- 1 min
- 5 min
- 10 min
- 15 min
- 30 min

- 1 hour





→ **Auto Power Off Delay [20 sec]**

Use the **Auto Power Off Delay** option to set the automatic power-off delay time. Configuration options are listed below.

- 20 sec **DEFAULT**
- 1 min
- 5 min
- 10 min
- 30 min
- 1 hour
- 6 hour
- 18 hour

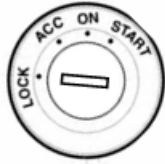
**4.3.5.1 Power State**

The following table shows the relation of the power state and vehicle ignition system. The auto start-up and shut down time delay can be set by the BIOS options listed above.

	LOCK	ACC	ON	START
				
<b>ACC Signal</b>	Off	On	On	Off
<b>Car Cigarette Lighter</b>	Off	On	On	Off
<b>5 V Standby Power</b>	Off	On after 1 second	On	On
<b>Auto Start-up</b>	--	Set by <b>Auto Power On Delay</b> BIOS option		--
<b>Auto Shut-down</b>	Set by <b>Auto Power Off Delay</b> BIOS option	--	--	--

**Table 4-2: Power State and Ignition System**



## IVS-110 Embedded System

### 4.3.6 USB Configuration

Use the **USB Configuration** menu (**BIOS Menu 10**) to read USB configuration information and configure the USB settings.

```

Aptio Setup Utility - Copyright (C) 2017 American Megatrends, Inc.
  Advanced
USB Configuration
USB Devices:
  1 Keyboard, 1 Hub
Legacy USB Support          [Enabled]
-----
-><: Select Screen
↑↓: Select Item
Enter: Select
+/-: Change Opt.
F1: General Help
F2: Previous Values
F3: Optimized Defaults
F4: Save & Exit
ESC: Exit
Version 2.18.1263. Copyright (C) 2017 American Megatrends, Inc.
  
```

#### BIOS Menu 10: USB Configuration

##### ➔ USB Devices

The **USB Devices** field lists the USB devices that are enabled on the system

##### ➔ Legacy USB Support [Enabled]

Use the **Legacy USB Support** BIOS option to enable USB mouse and USB keyboard support. Normally if this option is not enabled, any attached USB mouse or USB keyboard does not become available until a USB compatible operating system is fully booted with all USB drivers loaded. When this option is enabled, any attached USB mouse or USB keyboard can control the system even when there is no USB driver loaded onto the system.

- ➔ **Enabled**      **DEFAULT**      Legacy USB support enabled
- ➔ **Disabled**                      Legacy USB support disabled
- ➔ **Auto**                              Legacy USB support disabled if no USB devices are connected

### 4.3.7 CPU Configuration

Use the **CPU Configuration** menu (**BIOS Menu 11**) to view detailed CPU specifications and configure the CPU.

```

Aptio Setup Utility - Copyright (C) 2017 American Megatrends, Inc.
-----
Advanced
-----
CPU Configuration
-----
Intel(R) Atom(TM) Processor E3950 @ 1.60GHz
CPU Signature                506C9
Microcode Patch              28
Max CPU Speed                1600 MHz
Min CPU Speed                800 MHz
Processor Cores               4
Intel HT Technology           Not Supported
Intel VT-x Technology         Supported

L1 Data Cache                24 KB x 4
L1 Code Cache                32 KB x 4
L2 Cache                     1024 KB x 2
L3 Cache                     Not Present
64-bit                       Supported

EIST                          [Enabled]
C-States                     [Disabled]
Intel Virtualization Technology [Disabled]
VT-d                         [Disabled]

-----
Enable/Disable Intel SpeedStep
-----

-----
➔←: Select Screen
↑↓: Select Item
Enter: Select
+/-: Change Opt.
F1: General Help
F2: Previous Values
F3: Optimized Defaults
F4: Save & Exit
ESC: Exit
-----
Version 2.18.1263. Copyright (C) 2017 American Megatrends, Inc.

```

#### BIOS Menu 11: CPU Configuration

The CPU Configuration menu (**BIOS Menu 11**) lists the following CPU details:

- CPU Signature: Lists the CPU signature value.
- Microcode Patch: Lists the microcode patch being used.
- Max CPU Speed: Lists the maximum CPU processing speed.
- Min CPU Speed: Lists the minimum CPU processing speed.
- Processor Cores: Lists the number of the processor core

## IVS-110 Embedded System

- Intel HT Technology: Indicates if Intel HT Technology is supported by the CPU.
- Intel VT-x Technology: Indicates if Intel VT-x Technology is supported by the CPU.
- L1 Data Cache: Lists the amount of data storage space on the L1 cache.
- L1 Code Cache: Lists the amount of code storage space on the L1 cache.
- L2 Cache: Lists the amount of storage space on the L2 cache.
- L3 Cache: Lists the amount of storage space on the L3 cache.
- 64-bit: Indicates if 64-bit system is supported by the CPU.

### → EIST [Enabled]

Use the **EIST** option to enable or disable the Enhanced Intel® SpeedStep Technology (EIST).

- **Disabled** Disables Enhanced Intel® SpeedStep Technology
- **Enabled** **DEFAULT** Enables Enhanced Intel® SpeedStep Technology

### → C-States [Disabled]

Use the **C-States** option to enable or disable the C-states.

- **Disabled** **DEFAULT** Disables the C-state
- **Enabled** Enables the C-state

### → Intel Virtualization Technology [Disabled]

Use the **Intel Virtualization Technology** option to enable or disable virtualization on the system. When combined with third party software, Intel® Virtualization technology allows several OSs to run on the same system at the same time.

- **Disabled** **DEFAULT** Disables Intel Virtualization Technology.
- **Enabled** Enables Intel Virtualization Technology.

### → VT-d [Disabled]

Use the **VT-d** option to enable or disable VT-d support.

- ➔ **Disabled**    **DEFAULT**    Disable VT-d support.
- ➔ **Enabled**                    Enable VT-d support.

### 4.3.8 RTC Wake Settings

The **RTC Wake Settings** menu (**BIOS Menu 12**) configures RTC wake event.

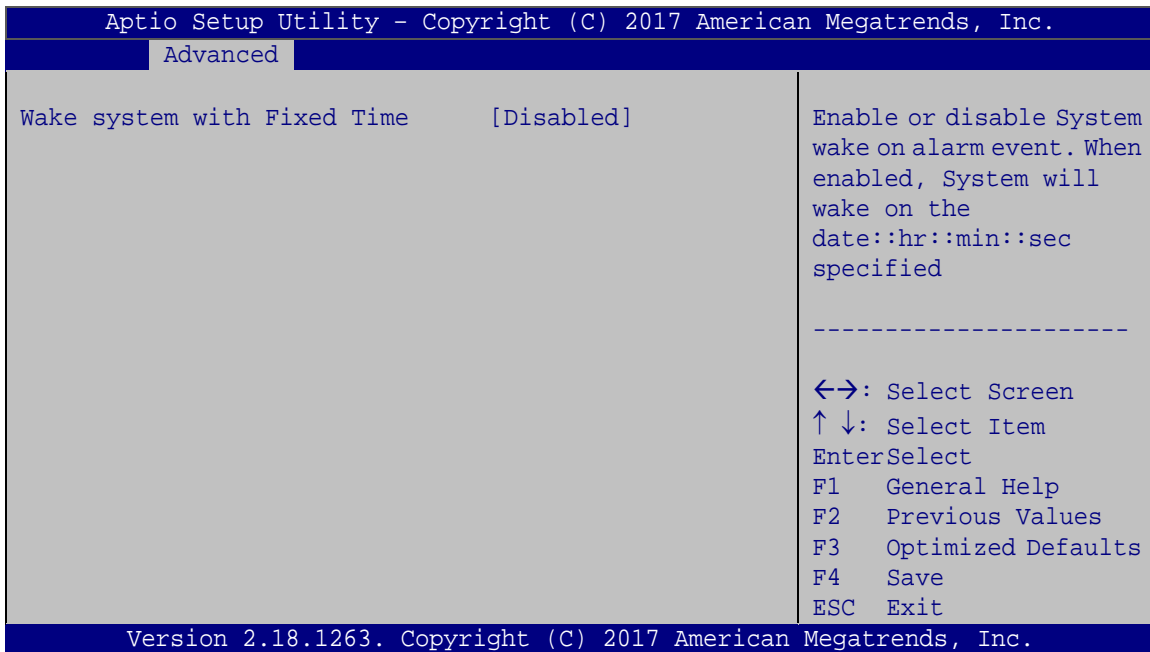

#### BIOS Menu 12: RTC Wake Settings

##### ➔ **Wake system with Fixed Time [Disabled]**

Use the **Wake system with Fixed Time** option to enable or disable the system wake on alarm event.

- ➔ **Disabled**    **DEFAULT**    The real time clock (RTC) cannot generate a wake event
- ➔ **Enabled**                    If selected, the **Wake up every day** option appears allowing you to enable to disable the system to wake every day at the specified time. Besides, the following options appear with values that can be

## IVS-110 Embedded System

selected:

Wake up date

Wake up hour

Wake up minute

Wake up second

After setting the alarm, the computer turns itself on from a suspend state when the alarm goes off.

### 4.3.9 Serial Port Console Redirection

The **Serial Port Console Redirection** menu (**BIOS Menu 13**) allows the console redirection options to be configured. Console redirection allows users to maintain a system remotely by re-directing keyboard input and text output through the serial port.

```

Aptio Setup Utility - Copyright (C) 2017 American Megatrends, Inc.
  Advanced
COM1
  Console Redirection          [Disabled]
> Console Redirection Settings

  Legacy Console Redirection
> Legacy Console Redirection Settings

-----
<=>: Select Screen
↑ ↓: Select Item
Enter>Select
F1   General Help
F2   Previous Values
F3   Optimized
     Defaults
F4   Save
ESC  Exit
Version 2.18.1263. Copyright (C) 2017 American Megatrends, Inc.
  
```

#### BIOS Menu 13: Serial Port Console Redirection

##### → Console Redirection [Disabled]

Use **Console Redirection** option to enable or disable the console redirection function.



- ➔ **Disabled**      **DEFAULT**      Disabled the console redirection function
- ➔ **Enabled**                      Enabled the console redirection function

### 4.3.9.1 Legacy Console Redirection Settings

The **Legacy Console Redirection Settings** menu (**BIOS Menu 14**) allows the legacy console redirection options to be configured.

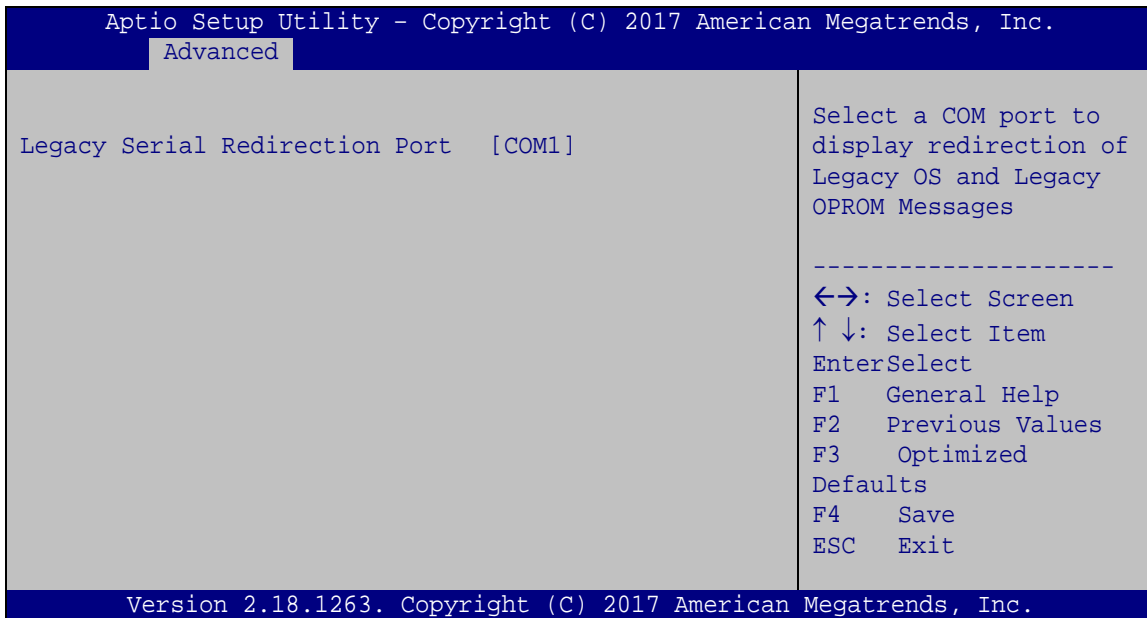

#### BIOS Menu 14: Legacy Console Redirection Settings

##### ➔ Legacy Serial Redirection Port [COM1]

Use the **Legacy Serial Redirection Port** option to specify a COM port to display redirection of legacy OS and legacy OPROM messages. The options include:

- **COM1**              **DEFAULT**

## IVS-110 Embedded System

### 4.3.10 IEI Feature

Use the **IEI Feature** menu (**BIOS Menu 15**) to configure One Key Recovery function.

```

Aptio Setup Utility - Copyright (C) 2017 American Megatrends, Inc.
-----
Advanced
-----
iEi Feature
Auto Recovery Function          [Disabled]
                                Auto Recovery Function
                                Reboot and recover
                                system automatically
                                within 10 min, when OS
                                crashes. Please install
                                Auto Recovery API
                                service before enabling
                                this function
                                -----
                                ←→: Select Screen
                                ↑↓: Select Item
                                Enter>Select
                                F1   General Help
                                F2   Previous Values
                                F3   Optimized Defaults
                                F4   Save
                                ESC  Exit
Version 2.18.1263. Copyright (C) 2017 American Megatrends, Inc.

```

#### BIOS Menu 15: IEI Feature

##### ➔ Auto Recovery Function [Disabled]

Use the **Auto Recovery Function** BIOS option to enable or disable the auto recovery function of the IEI One Key Recovery.

- ➔ **Disabled**      **DEFAULT**      Auto recovery function disabled
- ➔ **Enabled**        Auto recovery function enabled

## 4.4 Chipset

Use the **Chipset** menu (**BIOS Menu 16**) to access the North Bridge and South Bridge configuration menus.



### **WARNING!**

Setting the wrong values for the Chipset BIOS selections in the Chipset BIOS menu may cause the system to malfunction.

```

Aptio Setup Utility - Copyright (C) 2017 American Megatrends, Inc.
Main   Advanced  Chipset  Security  Boot   Save & Exit
-----
> North Bridge
> South Bridge

Host Bridge Parameters

-----
-><: Select Screen
↑ ↓: Select Item
Enter: Select
+/-: Change Opt.
F1: General Help
F2: Previous Values
F3: Optimized Defaults
F4: Save & Exit
ESC: Exit

Version 2.18.1263. Copyright (C) 2017 American Megatrends, Inc.
    
```

**BIOS Menu 16: Chipset**

## IVS-110 Embedded System

### 4.4.1 North Bridge Configuration

Use the **North Bridge** menu (**BIOS Menu 17**) to configure the north bridge chipset.

```

Aptio Setup Utility - Copyright (C) 2017 American Megatrends, Inc.
  Chipset
> Intel IGD Configuration
Memory Information
Total Memory                4096 MB (LPDDR3)
DIMM1                       2048 MB (LPDDR3)
DIMM2                       2048 MB (LPDDR3)

Config Intel IGD Settings.
-----
<->: Select Screen
↑ ↓: Select Item
EnterSelect
+ - Change Opt.
F1  General Help
F2  Previous Values
F3  Optimized Defaults
F4  Save & Exit
ESC Exit

Version 2.18.1263. Copyright (C) 2017 American Megatrends, Inc.
  
```

#### BIOS Menu 17: North Bridge

#### 4.4.1.1 Intel IGD Configuration

Use the **Intel IGD Configuration** submenu (**BIOS Menu 18**) to configure the graphics settings.

```

Aptio Setup Utility - Copyright (C) 2017 American Megatrends, Inc.
  Chipset
Intel IGD Configuration
Primary Display              [IGD]
Integrated Graphics Device   [Enable]
DVMT Pre-Allocated          [256M]
DVMT Total Gfx Mem          [Max]

Select which of IGD/PCI Graphics device should be Primary Display.
-----
<->: Select Screen
↑ ↓: Select Item
EnterSelect
+ - Change Opt.
F1  General Help
F2  Previous Values
F3  Optimized Defaults
F4  Save & Exit
ESC Exit

Version 2.18.1263. Copyright (C) 2017 American Megatrends, Inc.
  
```

#### BIOS Menu 18: Intel IGD Configuration

### → Primary Display [IGD]

Use the **Primary Display** option to select the graphics controller used as the primary boot device. Select either an integrated graphics controller (IGD) or a PCI express (PEG) controller. Configuration options are listed below:

- IGD                      **DEFAULT**
- PCIe

### → Integrated Graphics Device [Enable]

Use the **Integrated Graphics Device** BIOS option to enable or disable the Integrated Graphics Device (IGD).

- **Disable**                      Disable IGD
- **Enable**                      **DEFAULT**      Enable IGD

### → DVMT Pre-Allocated [256M]

Use the **DVMT Pre-Allocated** option to specify the amount of system memory that can be used by the internal graphics device.

- **64M**                              64 MB of memory used by internal graphics device
- **128M**                            128 MB of memory used by internal graphics device
- **256M**                            **DEFAULT**      256 MB of memory used by internal graphics device
- **512M**                            512 MB of memory used by internal graphics device

### → DVMT Total Gfx Mem [MAX]

Use the **DVMT Total Gfx Mem** option to specify the maximum amount of memory that can be allocated as graphics memory. Configuration options are listed below.

- 128MB
- 256MB



## IVS-110 Embedded System

- MAX      Default

### 4.4.2 South Bridge Configuration

Use the **South Bridge** menu (**BIOS Menu 19**) to configure the audio device connected to the system.

```

Aptio Setup Utility - Copyright (C) 2017 American Megatrends, Inc.
  Chipset
-----
> HD-Audio Configuration
> PCI Express Configuration
> SATA Configuration

HD-Audio Configuration
Settings

-----
<=>: Select Screen
↑ ↓: Select Item
Enter>Select
+ - Change Opt.
F1  General Help
F2  Previous Values
F3  Optimized Defaults
F4  Save & Exit
ESC Exit

Version 2.18.1263. Copyright (C) 2017 American Megatrends, Inc.
  
```

**BIOS Menu 19: South Bridge**

### 4.4.2.1 HD-Audio Configuration

Use the **HD-Audio Configuration** menu (**BIOS Menu 20**) to configure the HD Audio.

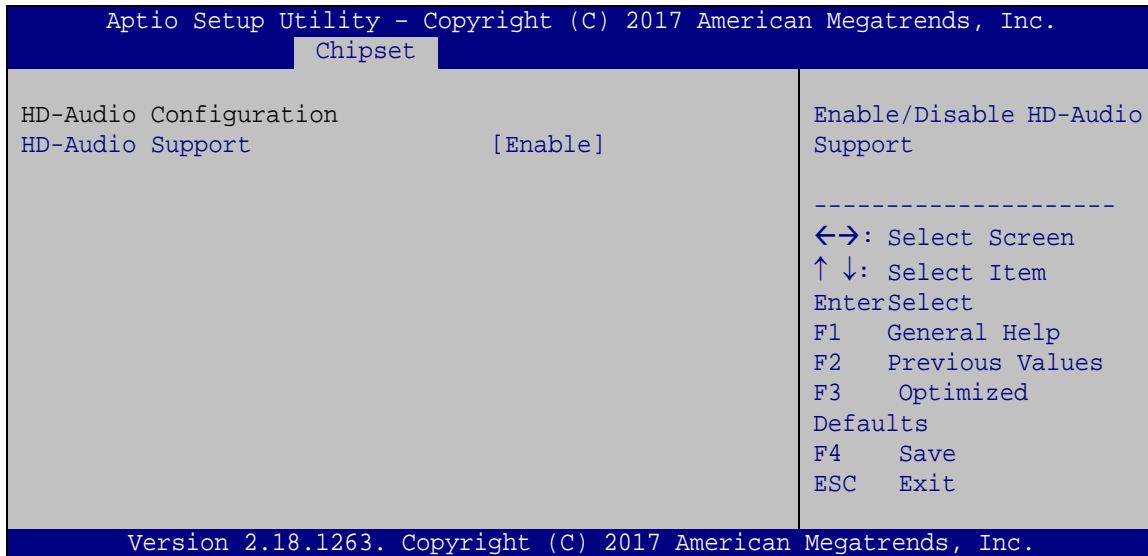

#### BIOS Menu 20: HD-Audio Configuration

##### → HD-Audio Support [Enable]

Use the **HD-Audio Support** option to enable or disable the High Definition Audio controller.

- **Disable**                      The onboard High Definition Audio controller is disabled
- **Enable**      **DEFAULT**      The onboard High Definition Audio controller is detected automatically and enabled

## IVS-110 Embedded System

### 4.4.2.2 PCI Express Configuration

Use the **PCI Express Configuration** menu (**BIOS Menu 21**) to configure the PCI Express.

```
Aptio Setup Utility - Copyright (C) 2017 American Megatrends, Inc.
Chipset
PCI Express Configuration
> Onboard LAN1
> MINI-PCIE2
> MINI-PCIE3
Control the PCI Express Root Port.
Enable: Enable PCIe root port
Disable: Disable PCIe root port
-----
<=>: Select Screen
↑ ↓: Select Item
Enter>Select
F1   General Help
F2   Previous Values
F3   Optimized
Defaults
F4   Save
ESC  Exit
Version 2.18.1263. Copyright (C) 2017 American Megatrends, Inc.
```

#### BIOS Menu 21: PCI Express Configuration

**4.4.2.2.1 Onboard LAN1**

Use the **Onboard LAN1** menu (**BIOS Menu 22**) to configure the LAN 1 port.

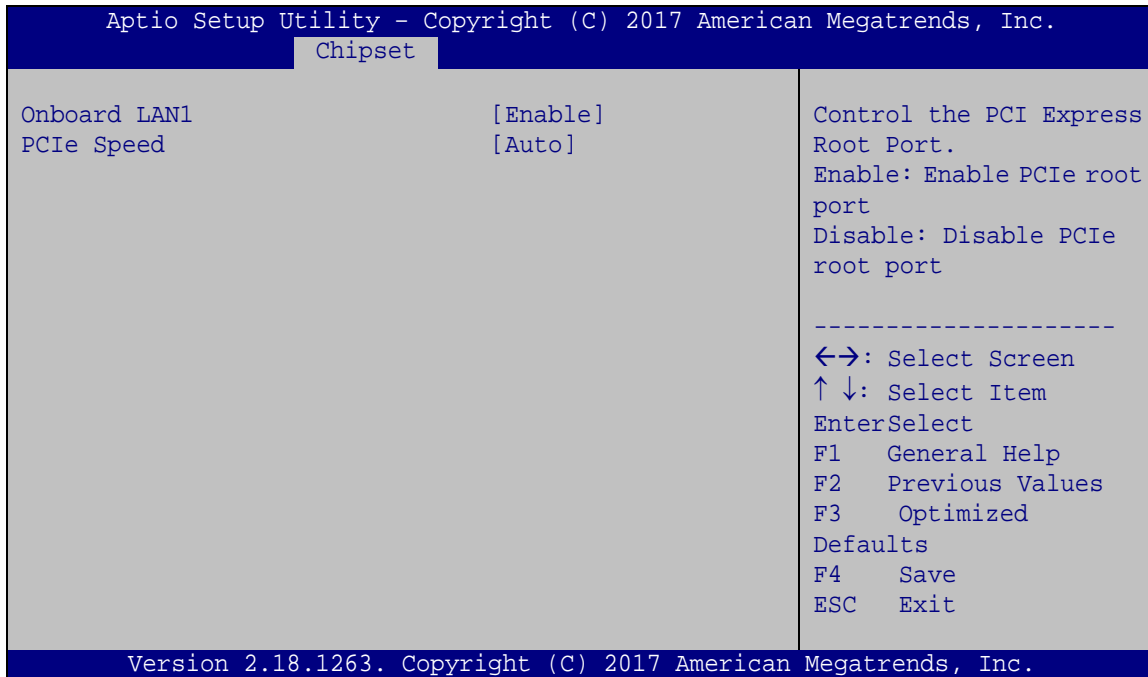

**BIOS Menu 22: RTL8111GN LAN**

➔ **Onboard LAN1 [Enable]**

Use the **Onboard LAN1** option to enable or disable the LAN port.

- ➔ **Disable**                      Disable the LAN port
- ➔ **Enable**            **DEFAULT**      Enable the LAN port

➔ **PCIe Speed [Auto]**

Use the **PCIe Speed** option to configure PCIe x1 slot speed.

- ➔ **Auto**            **DEFAULT**      Configure PCIe x1 slot speed to auto
- ➔ **Gen 1**                      Configure PCIe x1 slot speed to Gen1
- ➔ **Gen 2**                      Configure PCIe x1 slot speed to Gen2

## IVS-110 Embedded System

### 4.4.2.2.2 MINI-PCIE

Use the **MINI-PCIE** menu (**BIOS Menu 23**) to configure the PCIe Mini slots.

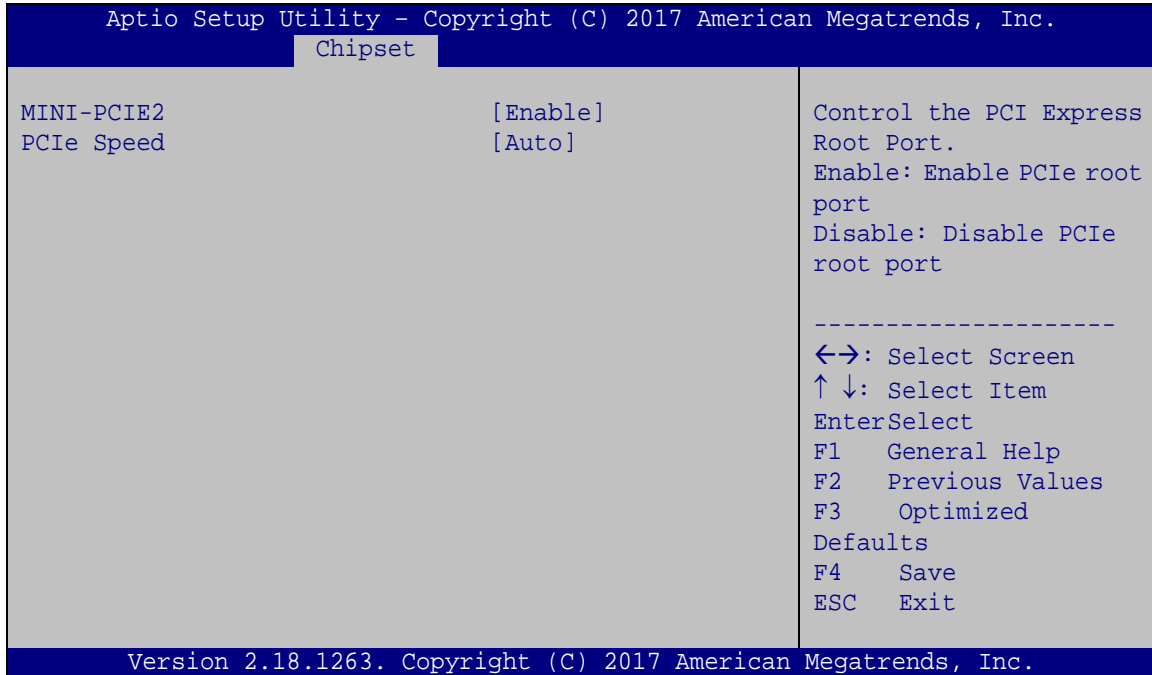

#### BIOS Menu 23: MINI-PCIE

##### → MINI-PCIE2 [Enable]

Use the **MINI-PCIE2** option to enable or disable the PCIe Mini slot (MINI-PCIE2).

- **Disable**                      **DEFAULT**      Disable PCIe Mini slot.
- **Enable**    Enable PCIe Mini slot.

##### → MINI-PCIE3 [Enable]

Use the **MINI-PCIE3** option to enable or disable the PCIe Mini slot (MINI-PCIE3).

- **Disable**                      **DEFAULT**      Disable PCIe Mini slot.
- **Enable**    Enable PCIe Mini slot.



### → PCIe Speed [Auto]

Use the **PCIe Speed** option to configure PCIe Mini slot speed.

- **Auto**            **DEFAULT**      Configure PCIe Mini slot speed to auto
- **Gen 1**                                 Configure PCIe Mini slot speed to Gen1
- **Gen 2**                                 Configure PCIe Mini slot speed to Gen2

### 4.4.2.3 SATA Configuration

Use the **SATA Configuration** menu (**BIOS Menu 24**) to change and/or set the configuration of the SATA devices installed in the system.

```

Aptio Setup Utility - Copyright (C) 2017 American Megatrends, Inc.
  Advanced
SATA Configuration
STAT Controller          [Enable]
SATA Mode Selection     [AHCI]

SATA Port 0
Hot Plug                IEI Tech Corp.(32.0GB)
                       [Disabled]

SATA Port 1
Hot Plug                IEI Tech Corp.(32.0GB)
                       [Disabled]

-----
←→: Select Screen
↑ ↓: Select Item
Enter>Select
F1  General Help
F2  Previous Values
F3  Optimized
Defaults
F4  Save
ESC Exit

Version 2.18.1263. Copyright (C) 2017 American Megatrends, Inc.
  
```

**BIOS Menu 24: SATA Configuration**

## IVS-110 Embedded System

### → STAT Controller [Enable]

Use the **STAT Controller** option to enable or disable the SATA device.

→ **Enable**      **DEFAULT**      Enables the SATA device.

→ **Disable**                      Disables the SATA device.

### → SATA Mode Selection [AHCI]

Use the **SATA Mode Selection** option to configure SATA devices as AHCI devices.

→ **AHCI**      **DEFAULT**      Configures SATA devices as AHCI device.

### → Hot Plug [Disabled]

Use the **Hot Plug** option to enable or disable the SATA device hot plug.

→ **Disabled**      **DEFAULT**      Disables the SATA device hot plug.

→ **Enabled**                      Enables the SATA device hot plug

## 4.5 Security

Use the **Security** menu (**BIOS Menu 25**) to set system and user passwords.



### BIOS Menu 25: Security

#### → Administrator Password

Use the **Administrator Password** to set or change an administrator password.

#### → User Password

Use the **User Password** to set or change a user password.

## IVS-110 Embedded System

### 4.6 Boot

Use the **Boot** menu (**BIOS Menu 26**) to configure system boot options.

```

Aptio Setup Utility - Copyright (C) 2017 American Megatrends, Inc.
Main   Advanced  Chipset  Security  Boot   Save & Exit
-----
Boot Configuration
Bootup NumLock State      [On]
Quiet Boot                 [Enabled]
Launch PXE OpROM          [Disabled]
Option ROM Messages       [Force BIOS]
UEFI Boot                  [Disabled]

Boot Option Priorities

-----
Select the keyboard
NumLock state

-----
-><: Select Screen
↑↓: Select Item
Enter: Select
+/-: Change Opt.
F1: General Help
F2: Previous Values
F3: Optimized Defaults
F4: Save & Exit
ESC: Exit

Version 2.18.1263. Copyright (C) 2017 American Megatrends, Inc.
  
```

#### BIOS Menu 26: Boot

##### → Bootup NumLock State [On]

Use the **Bootup NumLock State** BIOS option to specify if the number lock setting must be modified during boot up.

- **On**                      **DEFAULT**                      Allows the Number Lock on the keyboard to be enabled automatically when the computer system boots up. This allows the immediate use of the 10-key numeric keypad located on the right side of the keyboard. To confirm this, the Number Lock LED light on the keyboard is lit.
  
- **Off**                                      Does not enable the keyboard Number Lock automatically. To use the 10-keys on the keyboard, press the Number Lock key located on the upper left-hand corner of the 10-key pad. The Number Lock LED on the keyboard lights up when the Number Lock is engaged.

**→ Quiet Boot [Enabled]**

Use the **Quiet Boot** BIOS option to select the screen display when the system boots.

- **Disabled** Normal POST messages displayed
- **Enabled** **DEFAULT** OEM Logo displayed instead of POST messages

**→ Launch PXE OpROM [Disabled]**

Use the **Launch PXE OpROM** option to enable or disable boot option for legacy network devices.

- **Disabled** **DEFAULT** Ignore all PXE Option ROMs
- **Enabled** Load PXE Option ROMs.

**→ Option ROM Messages [Force BIOS]**

Use the **Option ROM Messages** option to set the Option ROM display mode.

- **Force BIOS** **DEFAULT** Sets display mode to force BIOS.
- **Keep Current** Sets display mode to current.

**→ UEFI Boot [Disabled]**

Use the **UEFI Boot** option to enable or disable to boot from the UEFI devices.

- **Enabled** Boot from UEFI devices is enabled.
- **Disabled** **DEFAULT** Boot from UEFI devices is disabled.



## IVS-110 Embedded System

### 4.7 Save & Exit

Use the **Save & Exit** menu (**BIOS Menu 27**) to load default BIOS values, optimal failsafe values and to save configuration changes.

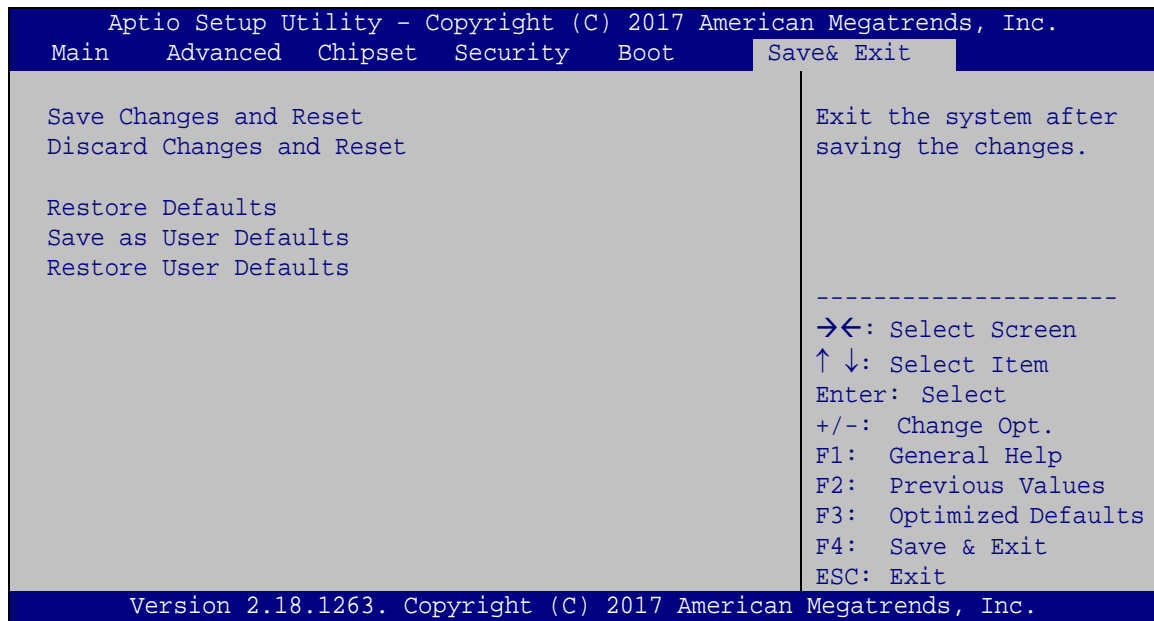

#### BIOS Menu 27: Save & Exit

##### → Save Changes and Reset

Use the **Save Changes and Reset** option to save the changes made to the BIOS options and reset the system.

##### → Discard Changes and Reset

Use the **Discard Changes and Reset** option to exit the system without saving the changes made to the BIOS configuration setup program.

##### → Restore Defaults

Use the **Restore Defaults** option to load the optimal default values for each of the parameters on the Setup menus. **F3 key can be used for this operation.**

##### → Save as User Defaults

Use the **Save as User Defaults** option to save the changes done so far as user defaults.

### → Restore User Defaults

Use the **Restore User Defaults** option to restore the user defaults to all the setup options.

Chapter

5

# Troubleshooting and Maintenance

---

**WARNING:**

Take Anti-Static precautions whenever maintenance is being carried out on the system components. Failure to take anti-static precautions can cause permanent system damage. For more details on anti-static precautions, please refer to **Section 3.1**.

---

## 5.1 System Maintenance Overview

---

**NOTE:**

When doing maintenance operations on the system, please follow the instructions in this chapter. Failure to follow these instructions may lead to personal injury and system damage.

---

To preserve the working integrity of the IVS-110 embedded system, the system must be properly maintained. If embedded system components need replacement, the proper maintenance procedures must be followed to ensure the system can continue to operate normally.

## 5.2 System Troubleshooting

This section provides some simple troubleshooting suggestions.

### 5.2.1 The System Doesn't Turn On

If after turning the system on, there is no power (indicated by the power LED on the front panel not turning on) please do the following:

- Step 1:** Check that the power cable connector is properly connected to the system rear panel.

## IVS-110 Embedded System

**Step 2:** Check that the power cable connector is properly plugged into the power source.

**Step 3:** Make sure the power button is turned on.

**Step 4:** Plug the system into a monitor and check to see if anything appears on the screen. If the boot-up screen appears it means the power LED has failed. To fix this problem, contact an IEI sales representative directly.

### 5.2.2 The System Doesn't Boot Up

If the system doesn't boot up please do the following:

**Step 1:** Check the power is turned on. See **Section 5.2.1** above.

**Step 2:** Make sure the SO-DIMM modules are properly installed.

### 5.2.3 More Troubleshooting

**Nothing appears on the monitor after booting up the system:** Make sure the monitor is properly connected to the system and the monitor is connected to a power supply and turned on.



#### **WARNING:**

If all troubleshooting measures have been taken and the system still fails to start, contact the IEI reseller or vendor you purchased the IVS-110 from or contact an IEI sales representative directly. To contact an IEI sales representative, please send an email to [sales@ieiworld.com](mailto:sales@ieiworld.com).

---

## 5.3 Maintenance

To configure the jumper settings, please follow the steps below.

**Step 1:** Remove the bottom surface. See **Section 3.4**.

**Step 2:** Locate the jumper/button on the embedded motherboard.



**Step 3:** Make the jumper settings in accordance with the settings described and defined in the following sections.

### 5.3.1 TXE Override Jumper

The TXE Override jumper (J\_FLASH1) allows users to enable or disable the TXE firmware update. Refer to **Figure 5-1** and **Table 5-1** for the jumper location and settings.

Setting	Description
Short 1-2	Disabled (default)
Short 2-3	Enabled

**Table 5-1: TXE Override Jumper Settings**

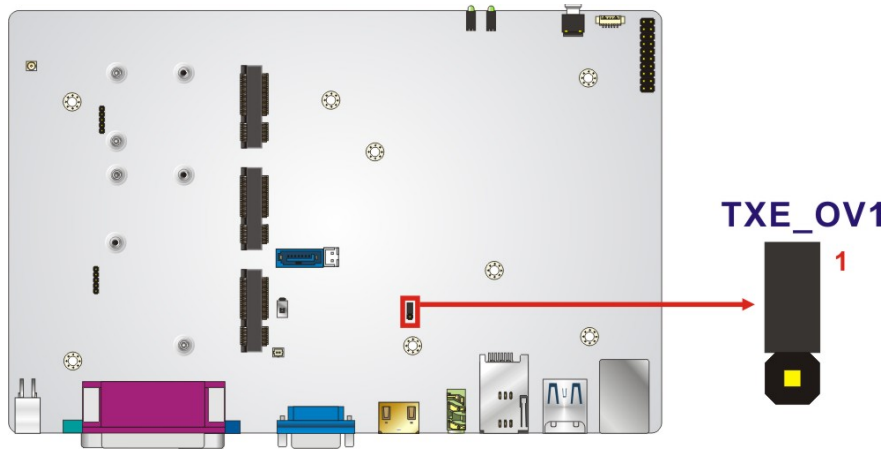

**Figure 5-1: TXE Override Jumper Location**

To update the TXE firmware, please follow the steps below.

- Step 1:** Before turning on the system power, short pin 2-3 of the TXE Override jumper.
- Step 2:** Update the BIOS and TXE firmware, and then turn off the system power.
- Step 3:** Remove the metal clip on the TXE Override jumper or return to its default setting (short pin 1-2).
- Step 4:** Restart the system. The system will reboot to complete the TXE firmware update.

Chapter

6

# Interface Connectors

---

## 6.1 Peripheral Interface Connectors

The IVS-110 series' motherboard comes with a number of peripheral interface connectors and configuration jumpers. The connector locations are shown in **Figure 6-1**. The Pin 1 locations of the on-board connectors are also indicated in the diagrams below. The connector pinouts for these connectors are listed in the following sections.

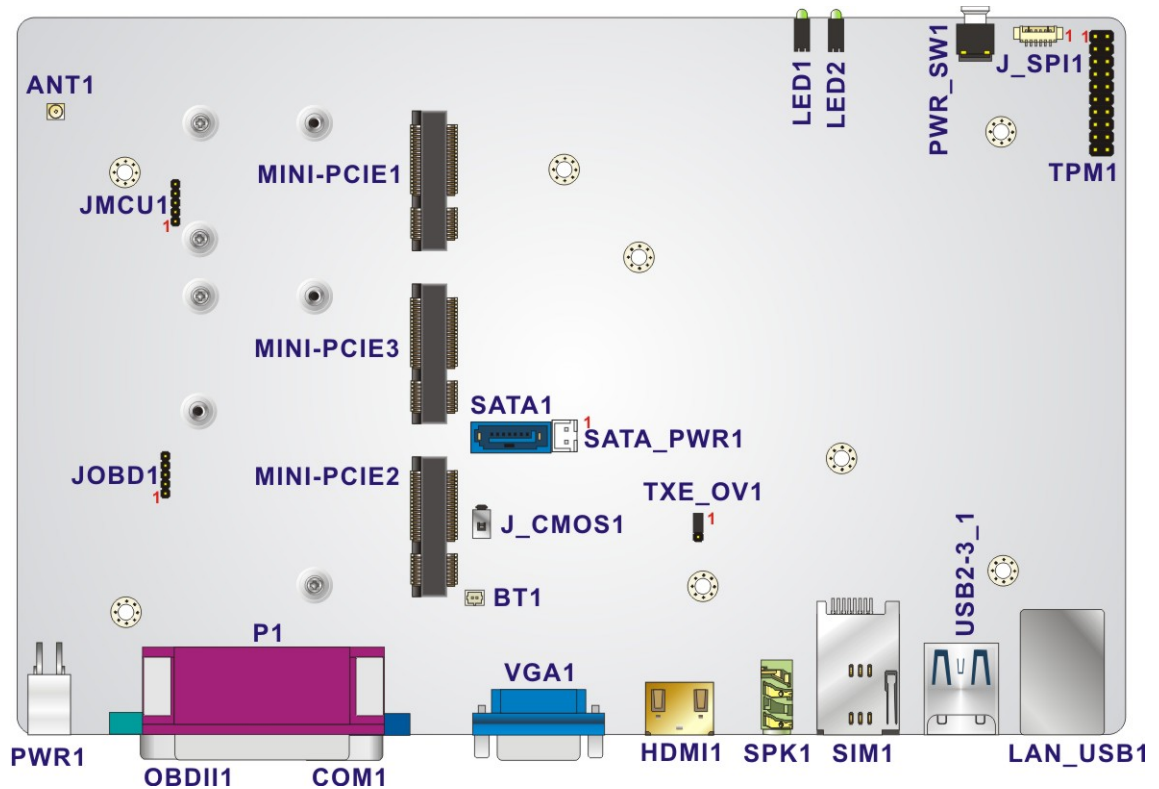

**Figure 6-1: Main Board Layout Diagram**

## 6.2 Internal Peripheral Connectors

Internal peripheral connectors (**Table 6-1**) are found on the motherboard and are only accessible when the motherboard is outside of the chassis. Pinouts of the internal connectors not described in the previous chapters can be found in the following sections.

Connector	Type	Label
Battery connector	2-pin wafer	BT1
GPS antenna connector	Coaxial connector	ANT1
MCU programming connector	5-pin header	JMCU1
mSATA/E-Window module slot	PCIe Mini card slot	MINI-PCIE3
OBD-II programming connector	5-pin header	JOB1
PCIe Mini card slot	PCIe Mini card slot	MINI-PCIE1
PCIe Mini card slot	PCIe Mini card slot	MINI-PCIE2
SATA connector	7-pin SATA	SATA1
SATA power connector	2-pin wafer	SATA_PWR1
SO-DIMM connector	SO-DIMM connector	DIMM1, DIMM2
SPI Flash connector, BIOS	8-pin header	J_SPI1
TPM connector (for debug only)	20-pin header	TPM1

**Table 6-1: Peripheral Interface Connectors**

### 6.2.1 Battery Connector (BT1)

PIN NO.	DESCRIPTION
1	VBATT
2	GND

**Table 6-2: Battery Connector (BT1) Pinouts**

### 6.2.2 MCU Programming Connector (JMCU1)

PIN NO.	DESCRIPTION
1	MCLR
2	+5V_MCU
3	GND
4	ICSPCLK2
5	ICSPDAT2

**Table 6-3: MCU Programming Connector (JMCU1) Pinouts**

### 6.2.3 OBD-II Programming Connector (JOB1)

PIN NO.	DESCRIPTION
1	MCLR#-1
2	+5V
3	GND
4	ICSP_CLK
5	ICSP_DAT

**Table 6-4: OBD-II Programming Connector (JOB1) Pinouts**

### 6.2.4 SATA Power Connector (SATA\_PWR1)

PIN NO.	DESCRIPTION
1	+V5S
2	GND

**Table 6-5: SATA Power Connector (SATA\_PWR1) Pinouts**



## IVS-110 Embedded System

### 6.2.5 SPI Flash Connector, BIOS (J\_SPI1)

PIN NO.	DESCRIPTION
1	+V3.3M_SPI_CON
2	SPI_CS
3	SPI_SO_SW
4	SPI_CLK_SW
5	SPI_SI_SW
6	GND

**Table 6-6: SPI Flash Connector (J\_SPI1) Pinouts**

### 6.2.6 TPM Connector (TPM1, Debug Only)

PIN NO.	DESCRIPTION	PIN NO.	DESCRIPTION
1	LCLK	2	GND
3	LFRAME#	4	KEY
5	LRERST#	6	+5V
7	LAD3	8	LAD2
9	+3V	10	LAD1
11	LAD0	12	GND
13	SCL	14	SDA
15	SB3V	16	SERIRQ
17	GND	18	CLKRUN#
19	LPCPD#	20	LDRO#

**Table 6-7: TPM Connector (TPM1, Debug Only) Pinouts**

Appendix

**A**

# Regulatory Compliance

---

**DECLARATION OF CONFORMITY**

This equipment is in conformity with the following EU directives:

- EMC Directive (2004/108/EC, 2014/30/EU)
- Low-Voltage Directive (2006/95/EC, 2014/35/EU)
- RoHS II Directive (2011/65/EU, 2015/863/EU)

If the user modifies and/or install other devices in the equipment, the CE conformity declaration may no longer apply.

If this equipment has telecommunications functionality, it also complies with the requirements of the Radio Equipment Directive 2014/53/EU.

---

English

IEI Integration Corp declares that this equipment is in compliance with the essential requirements and other relevant provisions of Directive 2014/53/EU.

---

Български [Bulgarian]

IEI Integration Corp. декларира, че този оборудване е в съответствие със съществените изисквания и другите приложими правила на Директива 2014/53/EU.

---

Česky [Czech]

IEI Integration Corp tímto prohlašuje, že tento zařizení je ve shodě se základními požadavky a dalšími příslušnými ustanoveními směrnice 2014/53/EU.

---

Dansk [Danish]

IEI Integration Corp erklærer herved, at følgende udstyr overholder de væsentlige krav og øvrige relevante krav i direktiv 2014/53/EU.

---

Deutsch [German]

IEI Integration Corp, erklärt dieses Gerät entspricht den grundlegenden Anforderungen und den weiteren entsprechenden Vorgaben der Richtlinie 2014/53/EU.

---

Eesti [Estonian]

IEI Integration Corp deklareerib seadme seadme vastavust direktiivi 2014/53/EÜ põhinõuetele ja nimetatud direktiivist tulenevatele teistele asjakohastele sätetele.

---

---

**Español [Spanish]**

IEI Integration Corp declara que el equipo cumple con los requisitos esenciales y cualesquiera otras disposiciones aplicables o exigibles de la Directiva 2014/53/EU.

---

**Ελληνική [Greek]**

IEI Integration Corp ΔΗΛΩΝΕΙ ΟΤΙ ΕΞΟΠΛΙΣΜΟΣ ΣΥΜΜΟΡΦΩΝΕΤΑΙ ΠΡΟΣ ΤΙΣ ΟΥΣΙΩΔΕΙΣ ΑΠΑΙΤΗΣΕΙΣ ΚΑΙ ΤΙΣ ΛΟΙΠΕΣ ΣΧΕΤΙΚΕΣ ΔΙΑΤΑΞΕΙΣ ΤΗΣ ΟΔΗΓΙΑΣ 2014/53/EU.

---

**Français [French]**

IEI Integration Corp déclare que l'appareil est conforme aux exigences essentielles et aux autres dispositions pertinentes de la directive 2014/53/EU.

---

**Italiano [Italian]**

IEI Integration Corp dichiara che questo apparecchio è conforme ai requisiti essenziali ed alle altre disposizioni pertinenti stabilite dalla direttiva 2014/53/EU.

---

**Latviski [Latvian]**

IEI Integration Corp deklarē, ka iekārta atbilst būtiskajām prasībām un citiem ar to saistītajiem noteikumiem Direktīvas 2014/53/EU.

---

**Lietuvių [Lithuanian]**

IEI Integration Corp deklaruoja, kad šis įranga atitinka esminius reikalavimus ir kitas 2014/53/EU Direktyvos nuostatas.

---

**Nederlands [Dutch]**

IEI Integration Corp dat het toestel toestel in overeenstemming is met de essentiële eisen en de andere relevante bepalingen van richtlijn 2014/53/EU.

---

**Malti [Maltese]**

IEI Integration Corp jiddikjara li dan prodott jikkonforma mal-ħtiġijiet essenzjali u ma provvedimenti oħrajn relevanti li hemm fid-Dirrettiva 2014/53/EU.

---

**Magyar [Hungarian]**

IEI Integration Corp nyilatkozom, hogy a berendezés megfelel a vonatkozó alapvető követelményeknek és az 2014/53/EU irányelv egyéb előírásainak.

---

**Polski [Polish]**

IEI Integration Corp oświadcza, że wyrobu jest zgodny z zasadniczymi wymogami oraz pozostałymi stosownymi postanowieniami Dyrektywy 2014/53/EU.

---

**Português [Portuguese]**

IEI Integration Corp declara que este equipamento está conforme com os requisitos essenciais e outras disposições da Directiva 2014/53/EU.

---

## IVS-110 Embedded System

---

Româna [Romanian]

IEI Integration Corp declară că acest echipament este în conformitate cu cerințele esențiale și cu celelalte prevederi relevante ale Directivei 2014/53/EU.

---

Slovensko [Slovenian]

IEI Integration Corp izjavlja, da je ta opreme v skladu z bistvenimi zahtevami in ostalimi relevantnimi določili direktive 2014/53/EU.

---

Slovensky [Slovak]

IEI Integration Corp týmto vyhlasuje, že zariadenia spĺňa základné požiadavky a všetky príslušné ustanovenia Smernice 2014/53/EU.

---

Suomi [Finnish]

IEI Integration Corp vakuuttaa täten että laitteet on direktiivin 2014/53/EU oleellisten vaatimusten ja sitä koskevien direktiivin muiden ehtojen mukainen.

---

Svenska [Swedish]

IEI Integration Corp förklarar att denna utrustningstyp står i överensstämmelse med de väsentliga egenskapskrav och övriga relevanta bestämmelser som framgår av direktiv 2014/53/EU.

---



**FCC WARNING**

This equipment complies with Part 15 of the FCC Rules. Operation is subject to the following two conditions:

- This device may not cause harmful interference, and
- This device must accept any interference received, including interference that may cause undesired operation.

This equipment has been tested and found to comply with the limits for a Class A digital device, pursuant to part 15 of the FCC Rules. These limits are designed to provide reasonable protection against harmful interference when the equipment is operated in a commercial environment. This equipment generates, uses, and can radiate radio frequency energy and, if not installed and used in accordance with the instruction manual, may cause harmful interference to radio communications. Operation of this equipment in a residential area is likely to cause harmful interference in which case the user will be required to correct the interference at his own expense.

**Federal Communication Commission Interference Statement**

This equipment has been assembled with components that comply with the limits for a Class B digital device, pursuant to Part 15 of the FCC Rules. These limits are designed to provide reasonable protection against harmful interference in a residential installation. This equipment generates, uses and can radiate radio frequency energy and, if not installed and used in accordance with the instructions, may cause harmful interference to radio communications. However, there is no guarantee that interference will not occur in a particular installation. If this equipment does cause harmful interference to radio or television reception, which can be determined by turning the equipment off and on, the user is encouraged to try to correct the interference by one of the following measures:

- Reorient or relocate the receiving antenna.
- Increase the separation between the equipment and receiver.
- Connect the equipment into an outlet on a circuit different from that to which the receiver is connected.
- Consult the dealer or an experienced radio/TV technician for help.

Appendix

**B**

# Safety Precautions

---

**WARNING:**

The precautions outlined in this chapter should be strictly followed. Failure to follow these precautions may result in permanent damage to the IVS-110.

## B.1 Safety Precautions

Please follow the safety precautions outlined in the sections that follow:

### B.1.1 General Safety Precautions

Please ensure the following safety precautions are adhered to at all times.

- ***Follow the electrostatic precautions*** outlined below whenever the device is opened.
- ***Make sure the power is turned off and the power cord is disconnected*** whenever the IVS-110 is being installed, moved or modified.
- ***To prevent the risk of electric shock, make sure power cord is unplugged from wall socket.*** To fully disengage the power to the unit, please disconnect the power cord from the power outlet. Refer servicing to qualified service personnel. The power outlet shall be readily available and accessible.
- ***Do not apply voltage levels that exceed the specified voltage range.*** Doing so may cause fire and/or an electrical shock. Use a power cord that matches the voltage of the power outlet, which has been approved and complies with the safety standard of your particular country.
- ***Electric shocks can occur*** if the IVS-110 chassis is opened when it is running. To avoid risk of electric shock, this device must only be connected to a supply mains with protective earth.
- ***Do not drop or insert any objects*** into the ventilation openings of the IVS-110.

## IVS-110 Embedded System

- **If considerable amounts of dust, water, or fluids enter the device**, turn off the power supply immediately, unplug the power cord, and contact the IVS-110 vendor.
- **DO NOT:**
  - Drop the device against a hard surface.
  - In a site where the ambient temperature exceeds the rated temperature

### B.1.2 Anti-static Precautions

---



#### **WARNING:**

Failure to take ESD precautions during the installation of the IVS-110 may result in permanent damage to the IVS-110 and severe injury to the user.

---

Electrostatic discharge (ESD) can cause serious damage to electronic components, including the IVS-110. Dry climates are especially susceptible to ESD. It is therefore critical that whenever the IVS-110 is opened and any of the electrical components are handled, the following anti-static precautions are strictly adhered to.

- **Wear an anti-static wristband:** Wearing a simple anti-static wristband can help to prevent ESD from damaging any electrical component.
- **Self-grounding:** Before handling any electrical component, touch any grounded conducting material. During the time the electrical component is handled, frequently touch any conducting materials that are connected to the ground.
- **Use an anti-static pad:** When configuring or working with an electrical component, place it on an anti-static pad. This reduces the possibility of ESD damage.
- **Only handle the edges of the electrical component:** When handling the electrical component, hold the electrical component by its edges.

### B.1.3 Product Disposal

---

**CAUTION:**

Risk of explosion if battery is replaced by an incorrect type. Only certified engineers should replace the on-board battery.

Dispose of used batteries according to instructions and local regulations.

---

- Outside the European Union – If you wish to dispose of used electrical and electronic products outside the European Union, please contact your local authority so as to comply with the correct disposal method.
- Within the European Union – The device that produces less waste and is easier to recycle is classified as electronic device in terms of the European Directive 2012/19/EU (WEEE), and must not be disposed of as domestic garbage.

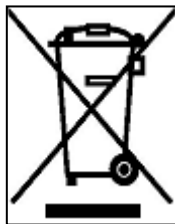

EU-wide legislation, as implemented in each Member State, requires that waste electrical and electronic products carrying the mark (left) must be disposed of separately from normal household waste. This includes monitors and electrical accessories, such as signal cables or power cords. When you need to dispose of your display products, please follow the guidance of your local authority, or ask the shop where you purchased the product. The mark on electrical and electronic products only applies to the current European Union Member States.

Please follow the national guidelines for electrical and electronic product disposal.



## IVS-110 Embedded System

### B.2 Maintenance and Cleaning Precautions

When maintaining or cleaning the IVS-110, please follow the guidelines below.



#### **WARNING:**

- For safety reasons, turn-off the power and unplug the embedded system before cleaning.
  - If you dropped any material or liquid such as water onto the embedded system when cleaning, unplug the power cable immediately and contact your dealer or the nearest service center. Always make sure your hands are dry when unplugging the power cable.
- 

#### B.2.1 Maintenance and Cleaning

Prior to cleaning any part or component of the IVS-110, please read the details below.

- Never spray or squirt liquids directly onto any other components. To clean the embedded system, gently wipe it with a piece of soft dry cloth or a slightly moistened cloth.
- The interior of the device does not require cleaning. Keep fluids away from the device interior.
- Be cautious of all small removable components when vacuuming the device.
- Never drop any objects or liquids through the openings of the device.
- Be cautious of any possible allergic reactions to solvents or chemicals used when cleaning the device.
- Avoid eating, drinking and smoking within vicinity of the device.

#### B.2.2 Cleaning Tools

Some components in the IVS-110 may only be cleaned using a product specifically designed for the purpose. In such case, the product will be explicitly mentioned in the cleaning tips. Below is a list of items to use when cleaning the IVS-110.

- **Cloth** – Although paper towels or tissues can be used, a soft, clean piece of cloth is recommended when cleaning the device.

- **Water or rubbing alcohol** – A cloth moistened with water or rubbing alcohol can be used to clean the device.
- **Using solvents** – The use of solvents is not recommended when cleaning the device as they may damage the plastic parts.
- **Vacuum cleaner** – Using a vacuum specifically designed for computers is one of the best methods of cleaning the device. Dust and dirt can restrict the airflow in the device and cause its circuitry to corrode.
- **Cotton swabs** – Cotton swabs moistened with rubbing alcohol or water are excellent tools for wiping hard to reach areas.
- **Foam swabs** – Whenever possible, it is best to use lint free swabs such as foam swabs for cleaning.

Appendix

**C**

# BIOS Menu Options

---

## C.1 BIOS Configuration Options

Below is a list of BIOS configuration options described in **Chapter 4**.

<input type="checkbox"/>	System Date [xx/xx/xx] .....	42
<input type="checkbox"/>	System Time [xx:xx:xx] .....	42
<input type="checkbox"/>	Security Device Support [Disable] .....	44
<input type="checkbox"/>	ACPI Sleep State [S3 (Suspend to RAM)] .....	45
<input type="checkbox"/>	Serial Port [Enabled] .....	47
<input type="checkbox"/>	Change Settings [IO=3F8h; IRQ=4] .....	47
<input type="checkbox"/>	Transfer Mode [RS232] .....	48
<input type="checkbox"/>	Serial Port [Enabled] .....	48
<input type="checkbox"/>	Change Settings [IO=2F8h; IRQ=3] .....	48
<input type="checkbox"/>	Serial Port [Enabled] .....	49
<input type="checkbox"/>	Change Settings [IO=3E8h; IRQ=10] .....	49
<input type="checkbox"/>	Serial Port [Enabled] .....	49
<input type="checkbox"/>	Change Settings [IO=2E8h; IRQ=10] .....	49
<input type="checkbox"/>	PC Health Status .....	50
<input type="checkbox"/>	CPU_FAN1 Smart Fan Control [Auto Duty-Cycle Mode] .....	52
<input type="checkbox"/>	CPU Temperature 1 .....	52
<input type="checkbox"/>	CPU Temperature 2 .....	52
<input type="checkbox"/>	CPU Temperature 3 .....	52
<input type="checkbox"/>	CPU Temperature 4 .....	52
<input type="checkbox"/>	Low Voltage Warning [9V] .....	53
<input type="checkbox"/>	Auto Power On Delay [10 sec] .....	53
<input type="checkbox"/>	Auto Power Off Delay [20 sec] .....	54
<input type="checkbox"/>	USB Devices .....	55
<input type="checkbox"/>	Legacy USB Support [Enabled] .....	55
<input type="checkbox"/>	EIST [Enabled] .....	57
<input type="checkbox"/>	C-States [Disabled] .....	57
<input type="checkbox"/>	Intel Virtualization Technology [Disabled] .....	57
<input type="checkbox"/>	VT-d [Disabled] .....	57
<input type="checkbox"/>	Wake system with Fixed Time [Disabled] .....	58
<input type="checkbox"/>	Console Redirection [Disabled] .....	59
<input type="checkbox"/>	Legacy Serial Redirection Port [COM1] .....	60

## IVS-110 Embedded System

<input type="checkbox"/>	Auto Recovery Function [Disabled].....	61
<input type="checkbox"/>	Primary Display [IGD].....	64
<input type="checkbox"/>	Integrated Graphics Device [Enable].....	64
<input type="checkbox"/>	DVMT Pre-Allocated [256M].....	64
<input type="checkbox"/>	DVMT Total Gfx Mem [MAX].....	64
<input type="checkbox"/>	HD-Audio Support [Enable].....	66
<input type="checkbox"/>	Onboard LAN1 [Enable].....	68
<input type="checkbox"/>	PCIe Speed [Auto].....	68
<input type="checkbox"/>	MINI-PCIE2 [Enable].....	69
<input type="checkbox"/>	MINI-PCIE3 [Enable].....	69
<input type="checkbox"/>	PCIe Speed [Auto].....	70
<input type="checkbox"/>	STAT Controller [Enable].....	71
<input type="checkbox"/>	SATA Mode Selection [AHCI].....	71
<input type="checkbox"/>	Hot Plug [Disabled].....	71
<input type="checkbox"/>	Administrator Password.....	72
<input type="checkbox"/>	User Password.....	72
<input type="checkbox"/>	Bootup NumLock State [On].....	73
<input type="checkbox"/>	Quiet Boot [Enabled].....	74
<input type="checkbox"/>	Launch PXE OpROM [Disabled].....	74
<input type="checkbox"/>	Option ROM Messages [Force BIOS].....	74
<input type="checkbox"/>	UEFI Boot [Disabled].....	74
<input type="checkbox"/>	Save Changes and Reset.....	75
<input type="checkbox"/>	Discard Changes and Reset.....	75
<input type="checkbox"/>	Restore Defaults.....	75
<input type="checkbox"/>	Save as User Defaults.....	75
<input type="checkbox"/>	Restore User Defaults.....	76



Appendix

**D**

# Watchdog Timer

---

**NOTE:**

The following discussion applies to DOS environment. IEI support is contacted or the IEI website visited for specific drivers for more sophisticated operating systems, e.g., Windows and Linux.

The Watchdog Timer is provided to ensure that standalone systems can always recover from catastrophic conditions that cause the CPU to crash. This condition may have occurred by external EMI or a software bug. When the CPU stops working correctly, Watchdog Timer either performs a hardware reset (cold boot) or a Non-Maskable Interrupt (NMI) to bring the system back to a known state.

A BIOS function call (INT 15H) is used to control the Watchdog Timer:

**INT 15H:**

<b>AH – 6FH Sub-function:</b>	
AL – 2:	Sets the Watchdog Timer's period.
BL:	Time-out value (Its unit-second is dependent on the item "Watchdog Timer unit select" in CMOS setup).

**Table D-1: AH-6FH Sub-function**

Call sub-function 2 to set the time-out period of Watchdog Timer first. If the time-out value is not zero, the Watchdog Timer starts counting down. While the timer value reaches zero, the system resets. To ensure that this reset condition does not occur, calling sub-function 2 must periodically refresh the Watchdog Timer. However, the Watchdog timer is disabled if the time-out value is set to zero.

A tolerance of at least 10% must be maintained to avoid unknown routines within the operating system (DOS), such as disk I/O that can be very time-consuming.

**NOTE:**

When exiting a program it is necessary to disable the Watchdog Timer, otherwise the system resets.

**Example program:**

```
; INITIAL TIMER PERIOD COUNTER  
;  
W_LOOP:  
  
    MOV    AX, 6F02H    ;setting the time-out value  
    MOV    BL, 30      ;time-out value is 48 seconds  
    INT    15H  
  
    ;  
; ADD THE APPLICATION PROGRAM HERE  
;  
  
    CMP    EXIT_AP, 1    ;is the application over?  
    JNE    W_LOOP      ;No, restart the application  
  
    MOV    AX, 6F02H    ;disable Watchdog Timer  
    MOV    BL, 0        ;  
    INT    15H  
  
    ;  
; EXIT ;
```

Appendix

**E**

# **Hazardous Materials Disclosure**

---

The details provided in this appendix are to ensure that the product is compliant with the Peoples Republic of China (China) RoHS standards. The table below acknowledges the presences of small quantities of certain materials in the product, and is applicable to China RoHS only.

A label will be placed on each product to indicate the estimated “Environmentally Friendly Use Period” (EFUP). This is an estimate of the number of years that these substances would “not leak out or undergo abrupt change.” This product may contain replaceable sub-assemblies/components which have a shorter EFUP such as batteries and lamps. These components will be separately marked.

Please refer to the following table.

Part Name	Toxic or Hazardous Substances and Elements					
	Lead (Pb)	Mercury (Hg)	Cadmium (Cd)	Hexavalent Chromium (CR(VI))	Polybrominated Biphenyls (PBB)	Polybrominated Diphenyl Ethers (PBDE)
Housing	O	O	O	O	O	O
Display	O	O	O	O	O	O
Printed Circuit Board	O	O	O	O	O	O
Metal Fasteners	O	O	O	O	O	O
Cable Assembly	O	O	O	O	O	O
Fan Assembly	O	O	O	O	O	O
Power Supply Assemblies	O	O	O	O	O	O
Battery	O	O	O	O	O	O

O: This toxic or hazardous substance is contained in all of the homogeneous materials for the part is below the limit requirement in SJ/T11363-2006 (now replaced by GB/T 26572-2011).

X: This toxic or hazardous substance is contained in at least one of the homogeneous materials for this part is above the limit requirement in SJ/T11363-2006 (now replaced by GB/T 26572-2011).



## IVS-110 Embedded System

此附件旨在确保本产品符合中国 RoHS 标准。以下表格标示此产品中某有毒物质的含量符合中国 RoHS 标准规定的限量要求。

本产品上会附有“环境友好使用期限”的标签，此期限是估算这些物质“不会有泄漏或突变”的年限。本产品可能包含有较短的环境友好使用期限的可替换元件，像是电池或灯管，这些元件将会单独标示出来。

部件名称	有毒有害物质或元素					
	铅 (Pb)	汞 (Hg)	镉 (Cd)	六价铬 (CR(VI))	多溴联苯 (PBB)	多溴二苯 醚 (PBDE)
壳体	○	○	○	○	○	○
显示	○	○	○	○	○	○
印刷电路板	○	○	○	○	○	○
金属螺帽	○	○	○	○	○	○
电缆组装	○	○	○	○	○	○
风扇组装	○	○	○	○	○	○
电力供应组装	○	○	○	○	○	○
电池	○	○	○	○	○	○

○: 表示该有毒有害物质在该部件所有物质材料中的含量均在 SJ/T 11363-2006 (现由 GB/T 26572-2011 取代) 标准规定的限量要求以下。

X: 表示该有毒有害物质至少在该部件的某一均质材料中的含量超出 SJ/T 11363-2006 (现由 GB/T 26572-2011 取代) 标准规定的限量要求。