



MODEL:

uIBX-230-BT Series

Fanless Embedded System with Intel® Celeron® N2930 1.83 GHz,
VGA, GbE, One USB 3.0, Three USB 2.0,
One COM and RoHS Compliant

User Manual

Revision

Date	Version	Changes
11 November 2014	1.00	Initial release

Copyright

COPYRIGHT NOTICE

The information in this document is subject to change without prior notice in order to improve reliability, design and function and does not represent a commitment on the part of the manufacturer.

In no event will the manufacturer be liable for direct, indirect, special, incidental, or consequential damages arising out of the use or inability to use the product or documentation, even if advised of the possibility of such damages.

This document contains proprietary information protected by copyright. All rights are reserved. No part of this manual may be reproduced by any mechanical, electronic, or other means in any form without prior written permission of the manufacturer.

TRADEMARKS

All registered trademarks and product names mentioned herein are used for identification purposes only and may be trademarks and/or registered trademarks of their respective owners.

Table of Contents

1 INTRODUCTION.....	1
1.1 OVERVIEW.....	2
1.2 MODEL VARIATIONS	2
1.3 FEATURES.....	3
1.4 TECHNICAL SPECIFICATIONS	3
1.5 FRONT PANEL.....	4
1.6 REAR PANEL.....	5
1.7 DIMENSIONS.....	6
2 UNPACKING	7
2.1 ANTI-STATIC PRECAUTIONS	8
2.2 UNPACKING PRECAUTIONS.....	8
2.3 PACKING LIST.....	9
3 INSTALLATION	10
3.1 INSTALLATION PRECAUTIONS	11
3.2 INSTALLATION AND CONFIGURATION STEPS	11
3.3 HARD DISK DRIVE (HDD) INSTALLATION.....	11
3.4 AT/ATX MODE SELECTION	14
3.4.1 AT Power Mode.....	15
3.4.2 ATX Power Mode	15
3.5 RESET THE SYSTEM	15
3.6 POWERING ON THE SYSTEM.....	16
3.7 MOUNT THE SYSTEM.....	16
3.8 EXTERNAL PERIPHERAL INTERFACE CONNECTORS.....	17
3.8.1 Audio Connection.....	18
3.8.2 LAN Connection.....	19
3.8.3 RS-232Serial Port Connection.....	19
3.8.4 USB Device Connection.....	20
3.8.5 VGA Monitor Connection	21

4 SYSTEM MOTHERBOARD	23
4.1 OVERVIEW.....	24
4.1.1 <i>Layout</i>	24
4.2 INTERNAL PERIPHERAL CONNECTORS	24
4.2.1 <i>AT/ATX Mode Select Switch</i>	25
4.2.2 <i>Audio Connector</i>	26
4.2.3 <i>Battery Connector</i>	27
4.2.4 <i>BIOS FW Connector</i>	28
4.2.5 <i>Buzzer Connector</i>	29
4.2.6 <i>Clear CMOS Button</i>	29
4.2.7 <i>CPU Fan Connector</i>	30
4.2.8 <i>DDR3L SO-DIMM Slot</i>	31
4.2.9 <i>Display Port Connector</i>	32
4.2.10 <i>EC FW Connector</i>	33
4.2.11 <i>Front Panel Connector</i>	34
4.2.12 <i>LAN LED Connector</i>	34
4.2.13 <i>Power Button Connector</i>	35
4.2.14 <i>Reset Button Connector</i>	36
4.2.15 <i>RS-232 Serial Port Connector</i>	37
4.2.16 <i>SATA 3Gb/s Drive Connector</i>	38
4.2.17 <i>SATA Power Connector</i>	39
4.2.18 <i>USB Connector</i>	40
4.3 EXTERNAL INTERFACE PANEL CONNECTORS	40
4.3.1 <i>LAN Connector</i>	41
4.3.2 <i>Power Connector</i>	42
4.3.3 <i>USB Connectors</i>	42
4.3.1 <i>VGA Connector</i>	43
5 BIOS.....	44
5.1 INTRODUCTION.....	45
5.1.1 <i>Starting Setup</i>	45
5.1.2 <i>Using Setup</i>	45
5.1.3 <i>Getting Help</i>	46
5.1.4 <i>Unable to Reboot after Configuration Changes</i>	46
5.1.5 <i>BIOS Menu Bar</i>	46

5.2 MAIN.....	47
5.3 ADVANCED.....	48
5.3.1 ACPI Settings.....	49
5.3.2 IT8528 Super IO Configuration.....	50
5.3.2.1 Serial Port 1 Configuration.....	50
5.3.3 Hardware Monitor.....	51
5.3.3.1 Smart Fan Mode Configuration.....	52
5.3.4 RTC Wake Settings.....	55
5.3.5 Serial Port Console Redirection.....	56
5.3.5.1 Console Redirection Settings.....	57
5.3.6 CPU Configuration.....	60
5.3.7 IDE Configuration.....	61
5.3.8 USB Configuration.....	62
5.4 CHIPSET.....	63
5.4.1 North Bridge Configuration.....	64
5.4.1.1 Intel IGD Configuration.....	64
5.4.2 Southbridge Configuration.....	66
5.5 SECURITY.....	68
5.6 BOOT.....	69
5.7 EXIT.....	71
A SAFETY PRECAUTIONS.....	73
A.1 SAFETY PRECAUTIONS.....	74
A.1.1 General Safety Precautions.....	74
A.1.2 Anti-static Precautions.....	74
A.1.3 Product Disposal.....	75
A.2 MAINTENANCE AND CLEANING PRECAUTIONS.....	76
A.2.1 Maintenance and Cleaning.....	76
A.2.2 Cleaning Tools.....	76
B BIOS MENU OPTIONS.....	78
C WATCHDOG TIMER.....	81
D HAZARDOUS MATERIALS DISCLOSURE.....	84
D.1 HAZARDOUS MATERIALS DISCLOSURE TABLE FOR IPB PRODUCTS CERTIFIED AS ROHS COMPLIANT UNDER 2002/95/EC WITHOUT MERCURY.....	85

List of Figures

Figure 1-1: uIBX-230-BT	2
Figure 1-2: uIBX-230-BT Front Panel	5
Figure 1-3: uIBX-230-BT Rear Panel	5
Figure 1-4: Physical Dimensions (mm)	6
Figure 3-1: Retention Screws Removal	12
Figure 3-2: HDD Bracket	12
Figure 3-3: HDD Retention Screws	13
Figure 3-4: HDD Retention Screws	14
Figure 3-5: AT/ATX Switch Location.....	14
Figure 3-6: Reset Button Location.....	16
Figure 3-7: Power Button Location.....	16
Figure 3-8: Mounting Bracket.....	17
Figure 3-9: Audio Connector	18
Figure 3-10: LAN Connection	19
Figure 3-11: DB-9 Serial Port Connector.....	20
Figure 3-12: USB Device Connection	21
Figure 3-13: VGA Connector	22
Figure 4-1: System Motherboard	24
Figure 4-2: AT/ATX Mode Select Switch Location	26
Figure 4-3: Audio Connector Location	27
Figure 4-4: Battery Connector Location.....	28
Figure 4-5: BIOS FW Connector Location.....	28
Figure 4-6: Buzzer Connector Location	29
Figure 4-7: Clear CMOS Button Location.....	30
Figure 4-8: CPU Fan Connector Location	31
Figure 4-9: DDR3L SO-DIMM Slot Location	32
Figure 4-10: Display Port Connector Location	32
Figure 4-11: EC FW Connector Location.....	33
Figure 4-12: Front Panel Connector Location	34
Figure 4-13: LAN LED Connector Location	35

Figure 4-14: Power Button Connector Location.....	36
Figure 4-15: Reset Button Connector Location.....	37
Figure 4-16: RS-232 Serial Port Connector Location.....	38
Figure 4-17: SATA 3Gb/s Drive Connector Location	39
Figure 4-18: SATA Power Connector Location	39
Figure 4-19: USB Connector Location.....	40
Figure 4-20: LAN Connector	41
Figure 4-21: VGA Connector	43

List of Tables

Table 1-1: Model Variations	2
Table 1-2: Technical Specifications	4
Table 2-1: Package List Contents	9
Table 4-1: Peripheral Interface Connectors	25
Table 4-2: AT/ATX Mode Select Switch Settings	26
Table 4-3: Audio Connector Pinouts	27
Table 4-4: Battery Connector Pinouts	28
Table 4-5: BIOS FW Connector Pinouts	29
Table 4-6: Buzzer Connector Pinouts	29
Table 4-7: Clear CMOS Button Settings	30
Table 4-8: CPU Fan Connector Pinouts	31
Table 4-9: Display Port Connector Pinouts	33
Table 4-10: EC FW Connector Pinouts	34
Table 4-11: Front Panel Connector Pinouts	34
Table 4-12: LAN LED Connector Pinouts	35
Table 4-13: Power Button Connector Pinouts	36
Table 4-14: Reset Button Connector Pinouts	37
Table 4-15: RS-232 Serial Port Connector Pinouts	38
Table 4-16: SATA Power Connector Pinouts	39
Table 4-17: USB Connector Pinouts	40
Table 4-18: Rear Panel Connectors	41
Table 4-19: LAN Pinouts	41
Table 4-20: Connector LEDs	41
Table 4-21: Power Connector Pinouts	42
Table 4-22: USB 2.0 & USB 3.0 Port Pinouts	42
Table 4-23: VGA Connector Pinouts	43
Table 5-1: BIOS Navigation Keys	46

Chapter

1

Introduction

1.1 Overview



Figure 1-1: uIBX-230-BT

The uIBX-230-BT embedded system is a fanless system with one VGA port for display. It accepts an Intel® Celeron® N2930 1.83 GHz quad core processor and supports one 204-pin DDR3L 1.35V SO-DIMM module up to 8 GB. The uIBX-230-BT supports a 2.5" SATA HDD with up to 3 Gb/s data transfer rate. One serial port, one USB 3.0 port and three USB 2.0 ports ensure simplified connectivity to a variety of external peripheral devices.

1.2 Model Variations

The model variations of the uIBX-230-BT series are listed below.

Models	CPU	Memory
uIBX-230-BT-N2-R10	Intel® Celeron® N2930	w/o memory
uIBX-230-BT-N2/2G-R10	Intel® Celeron® N2930	2GB DDR3L pre-installed memory

Table 1-1: Model Variations

uIBX-230-BT Embedded System

1.3 Features

The uIBX-230-BT features are listed below:

- Ultra compact size embedded system
- Intel® Celeron® processor N2930 1.83 GHz 7.5W on-board
- 1 x 2.5" SATA 3Gb/s HDD/SSD drive bay
- DDR3L SO-DIMM for low power consumption

1.4 Technical Specifications

The uIBX-230-BT technical specifications are listed in **Table 1-2**.

Chassis	
Color	Silver
Dimensions (WxDxH)	137 x 102.8 x 52 (mm)
System Fan	Fanless
Chassis Construction	Extruded aluminum alloys
Motherboard	
CPU	Intel® Celeron® N2930 1.83 GHz
Chipset	SoC
System Memory	One 204-pin DDR3L 1.35V SO-DIMM 2GB pre-installed (system max capacity 8G)
Storage	
Hard Drive	1 x 2.5" SATA 3Gb/s HDD/SSD Bay
I/O Interfaces	
USB 3.0	1 x USB 3.0 port
USB 2.0	3 x USB 2.0 ports
Ethernet	1 x RJ-45 1 x PCIe GbE by Intel® I210
RS-232	1 x DB-9
Display	1 x VGA

Resolution	2560 x 1600
Audio	1 x Line-out, 1 x Mic-in
Power	
Power Input	DC Jack: 12 V DC
Power Consumption	12 V@1.8 A (Intel® Celeron® Processor N2930 with 2 GB memory)
Reliability	
Mounting	Wall mount
Operating Temperature	-20°C ~60°C with air flow (SSD), 5% ~ 95%, non-condensing
Operating Shock	Half-sine wave shock 5G, 11ms, 3 shocks per axis
Operating Vibration	MIL-STD-810F 514.5-1 (HDD), MIL-STD-810F 514.5 C-2 (SSD)
Weight (Net/Gross)	470 g/1.4 kg
Safety/EMC	CE/FCC
OS	
Supported OS	Microsoft® Windows® 8, Microsoft® Windows® Embedded Standard 7 E

Table 1-2: Technical Specifications

1.5 Front Panel

The front panel of the uIBX-230-BT has the following features (**Figure 1-2**):

- 1 x HDD LED
- 1 x Line out
- 1 x Mic
- 1 x Power button
- 1 x Reset button
- 1 x RS-232 serial port connector
- 2 x USB 2.0 connectors

uIBX-230-BT Embedded System



Figure 1-2: uIBX-230-BT Front Panel

1.6 Rear Panel

The rear panel of the uIBX-230-BT has the following features (Figure 1-3):

- 1 x AT/ATX Switch
- 1 x RJ-45 LAN connector
- 1 x USB 3.0 connector
- 1 x USB 2.0 connector
- 1 x 12 V DC IN
- 1 x VGA port

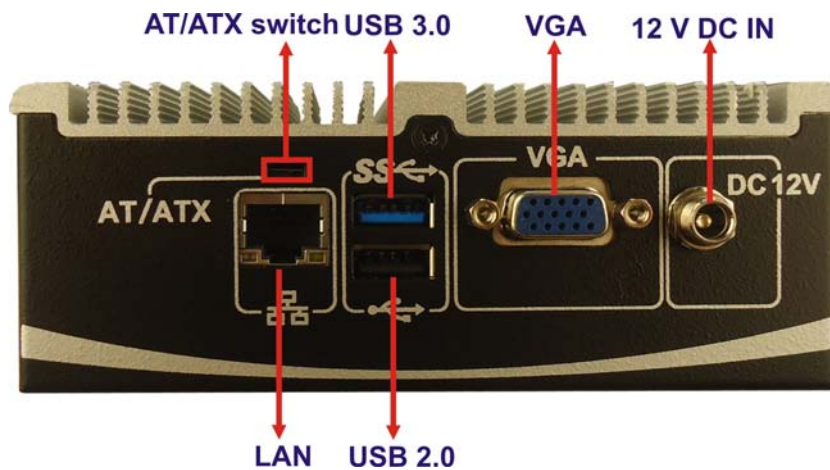

Figure 1-3: uIBX-230-BT Rear Panel

1.7 Dimensions

The physical dimensions are shown below:

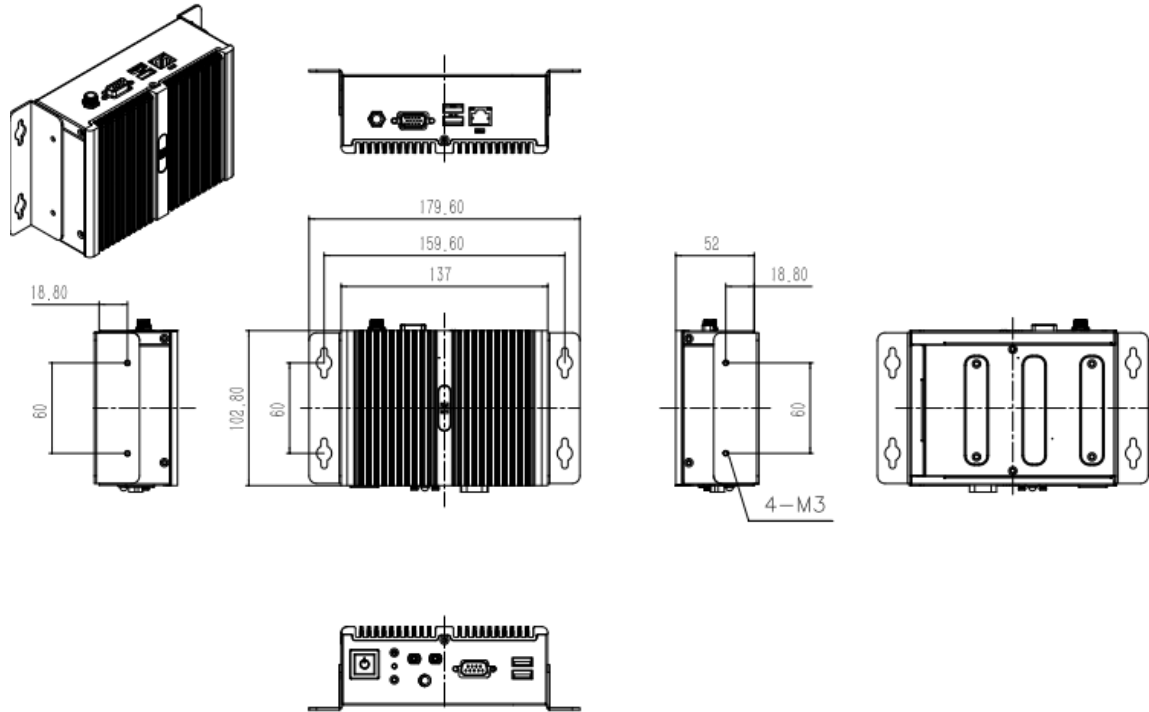

Figure 1-4: Physical Dimensions (mm)

Chapter

2

Unpacking

2.1 Anti-static Precautions



WARNING:

Failure to take ESD precautions during installation may result in permanent damage to the uIBX-230-BT and severe injury to the user.

Electrostatic discharge (ESD) can cause serious damage to electronic components, including the uIBX-230-BT. Dry climates are especially susceptible to ESD. It is therefore critical that whenever the uIBX-230-BT or any other electrical component is handled, the following anti-static precautions are strictly adhered to.

- **Wear an anti-static wristband:** Wearing a simple anti-static wristband can help to prevent ESD from damaging the board.
- **Self-grounding:** Before handling the board, touch any grounded conducting material. During the time the board is handled, frequently touch any conducting materials that are connected to the ground.
- **Use an anti-static pad:** When configuring the uIBX-230-BT, place it on an anti-static pad. This reduces the possibility of ESD damaging the uIBX-230-BT.

2.2 Unpacking Precautions

When the uIBX-230-BT is unpacked, please do the following:

- Follow the anti-static precautions outlined in **Section 2.1**.
- Make sure the packing box is facing upwards so the uIBX-230-BT does not fall out of the box.
- Make sure all the components shown in **Section 2.3** are present.

uIBX-230-BT Embedded System

2.3 Packing List



NOTE:

If some of the components listed in the checklist below are missing, please do not proceed with the installation. Contact the IEI reseller or vendor you purchased the uIBX-230-BT from or contact an IEI sales representative directly. To contact an IEI sales representative, please send an email to sales@iei.com.tw.

The uIBX-230-BT is shipped with the following components:



Quantity	Item and Part Number	Image
1	uIBX-230-BT	
1	1 x Power Adapter (P/N: 63000-FSP036RAB608-RS)	
1	1 x Power Cord (P/N: 32702-000401-100-RS)	
1	1 x Mounting Bracket (P/N: 41020-0403C2-00-RS)	

Table 2-1: Package List Contents

Chapter

3

Installation

uIBX-230-BT Embedded System

3.1 Installation Precautions

During installation, be aware of the precautions below:

- **Read the user manual:** The user manual provides a complete description of the uIBX-230-BT, installation instructions and configuration options.
- **DANGER! Disconnect Power:** Power to the uIBX-230-BT must be disconnected during the installation process, or before any attempt is made to access the rear panel. Electric shock and personal injury might occur if the rear panel of the uIBX-230-BT is opened while the power cord is still connected to an electrical outlet.
- **Qualified Personnel:** The uIBX-230-BT must be installed and operated only by trained and qualified personnel. Maintenance, upgrades, or repairs may only be carried out by qualified personnel who are familiar with the associated dangers.
- **Grounding:** The uIBX-230-BT should be properly grounded. The voltage feeds must not be overloaded. Adjust the cabling and provide external overcharge protection per the electrical values indicated on the label attached to the back of the uIBX-230-BT.

3.2 Installation and Configuration Steps

The following installation steps must be followed.

Step 1: Unpack the uIBX-230-BT.

Step 2: Configure the system.

Step 3: Connect peripheral devices to the uIBX-230-BT.

Step 4: Mount the uIBX-230-BT.

3.3 Hard Disk Drive (HDD) Installation

To install the hard drive, please follow the steps below:

Step 1: Remove three retention screws from the HDD cover (**Figure 3-1**).



Figure 3-1: Retention Screws Removal

Step 2: Open the HDD cover and locate the HDD bracket (**Figure 3-2**).



Figure 3-2: HDD Bracket

uIBX-230-BT Embedded System

Step 3: Attach the HDD to the HDD bracket, and then slide the HDD to connect the HDD to the SATA connector. (**Figure 3-3**).

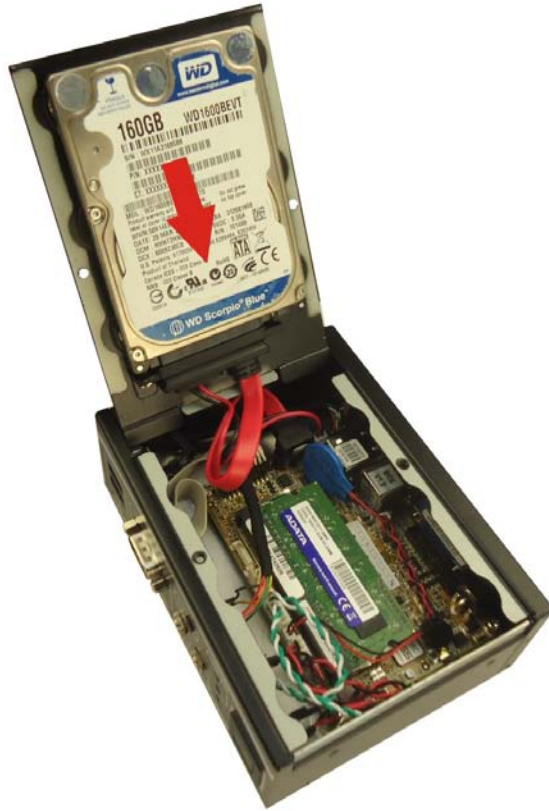

Figure 3-3: HDD Retention Screws

Step 4: Secure the HDD with the HDD bracket by four retention screws on the HDD cover.



Figure 3-4: HDD Retention Screws

Step 5: Replace the HDD cover and secure it using three previously removed retention screws.

3.4 AT/ATX Mode Selection

AT or ATX power mode can be used on the uIBX-230-BT. The selection is made through an AT/ATX switch located on the rear panel (Figure 3-5). To select AT mode or ATX mode, follow the steps below.

Step 1: Locate the AT/ATX switch on the rear panel (Figure 3-5).

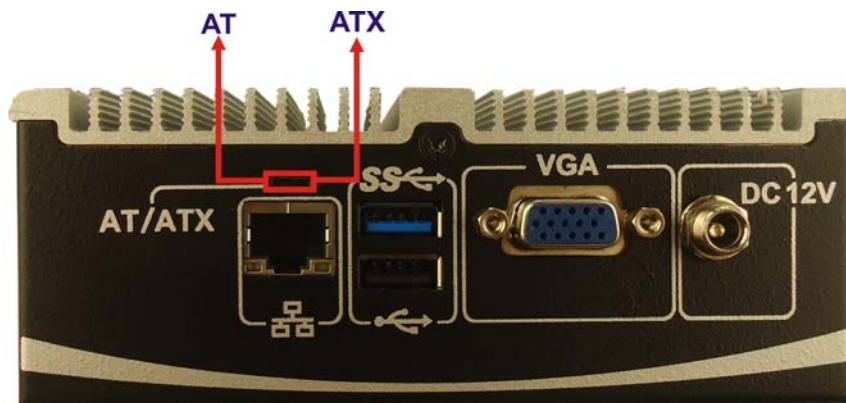

Figure 3-5: AT/ATX Switch Location

uIBX-230-BT Embedded System

Step 2: Adjust the AT/ATX switch.

3.4.1 AT Power Mode

With the AT mode selected, the power is controlled by a central power unit rather than a power switch. The uIBX-230-BT panel PC turns on automatically when the power is connected. The AT mode benefits a production line to control multiple panel PCs from a central management center and other applications including:

- ATM
- Self-service kiosk
- Plant environment monitoring system
- Factory automation platform
- Manufacturing shop flow

3.4.2 ATX Power Mode

With the ATX mode selected, the uIBX-230-BT panel PC goes in a standby mode when it is turned off. The panel PC can be easily turned on via network or a power switch in standby mode. Remote power control is perfect for advertising applications since the broadcasting time for each panel PC can be set individually and controlled remotely. Other possible application includes:

- Security surveillance
- Point-of-Sale (POS)
- Advertising terminal

3.5 Reset the System

The reset button enables user to reboot the system when the system is turned on. To reboot the system, follow the steps below.

Step 1: Locate the reset button on the rear panel (**Figure 3-6**).

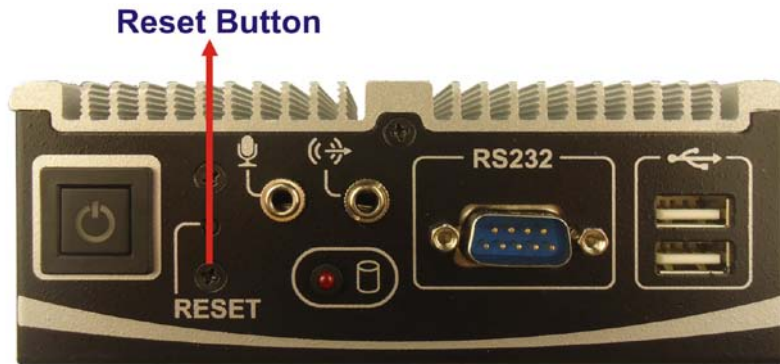

Figure 3-6: Reset Button Location

Step 2: Press the reset button.

3.6 Powering On the System

To power on the system, follow the steps below:

Step 1: Press the power button on the front panel (**Figure 3-7**).

Power button



Figure 3-7: Power Button Location

3.7 Mount the System

To mount the embedded system onto a wall or some other surface using the two mounting brackets, please follow the steps below.

Step 2: Turn the embedded system over.

Step 3: Align the two retention screw holes in each bracket with the corresponding retention screw holes on the left side and right side.

uIBX-230-BT Embedded System

- Step 4:** Secure the brackets to the system by inserting two retention screws into each bracket as illustrated in **Figure 3-8**.

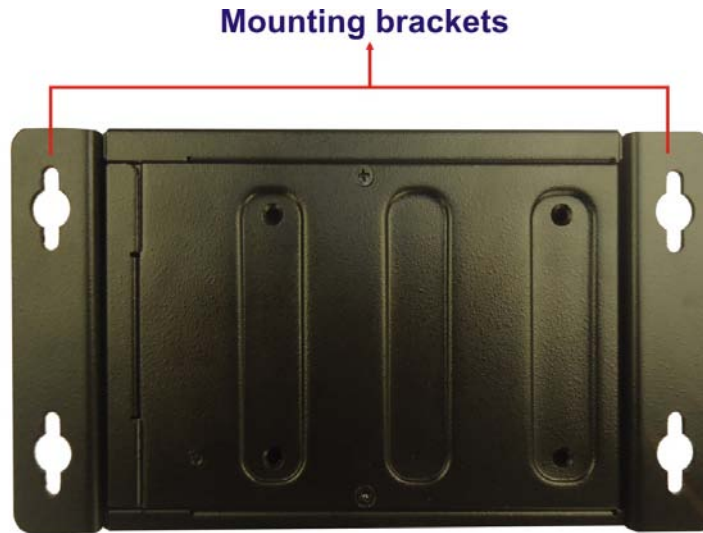

Figure 3-8: Mounting Bracket

- Step 5:** Drill holes in the intended installation surface.
- Step 6:** Align the mounting holes in the sides of the mounting brackets with the predrilled holes in the mounting surface.
- Step 7:** Insert four retention screws, two in each bracket, to secure the system to the wall.

3.8 External Peripheral Interface Connectors

The following external peripheral devices can be connected to the external peripheral interface connectors.

- Audio devices
- RJ-45 Ethernet cable connector
- Serial devices
- USB devices
- VGA monitor

3.8.1 Audio Connection

The audio jacks on the external audio connector enable the uIBX-230-BT to be connected to a stereo sound setup. To install the audio devices, follow the steps below.

- Step 1: Identify the audio plugs.** The plugs on your home theater system or speakers may not match the colors on the rear panel. If audio plugs are plugged into the wrong jacks, sound quality will be very bad.
- Step 2: Plug the audio plugs into the audio jacks.** Plug the audio plugs into the audio jacks. If the plugs on your speakers are different, an adapter will need to be used to plug them into the audio jacks.
- **Line Out port:** Connects to a headphone or a speaker.
 - **Microphone:** Connects to a microphone.

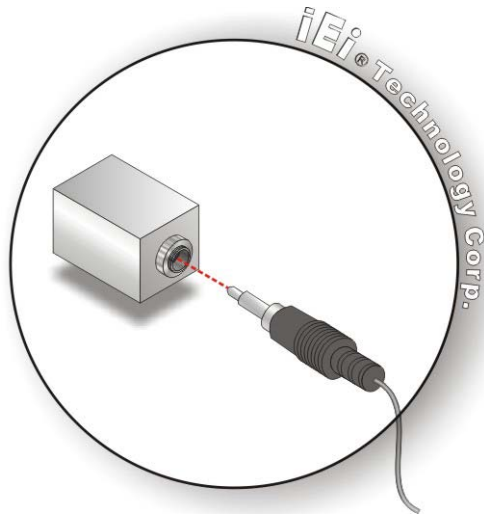

Figure 3-9: Audio Connector

- Step 3: Check audio clarity.** Check that the sound is coming through the right speakers by adjusting the balance front to rear and left to right.

uIBX-230-BT Embedded System

3.8.2 LAN Connection

There is one external RJ-45 LAN connector. The RJ-45 connector enables connection to an external network. To connect a LAN cable with an RJ-45 connector, please follow the instructions below.

Step 1: Locate the RJ-45 connectors. The location of the LAN connector is shown in **Chapter 1**.

Step 2: Align the connectors. Align the RJ-45 connector on the LAN cable with the RJ-45 connector on the uIBX-230-BT. See Figure 3-10.

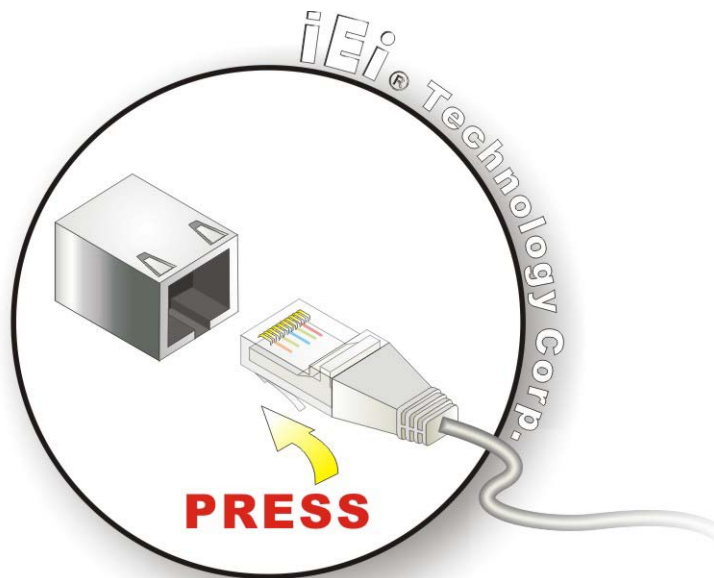

Figure 3-10: LAN Connection

Step 3: Insert the LAN cable RJ-45 connector. Once aligned, gently insert the LAN cable RJ-45 connector into the RJ-45 connector.

3.8.3 RS-232Serial Port Connection

There are one RS-232 DB-9 connectors of the uIBX-230-BT for serial device connection. Follow the steps below to connect a serial device to the DB-9 connector of the uIBX-230-BT.

Step 1: **Locate the DB-9 connector.** The locations of the DB-9 connectors are shown in **Chapter 1**.

Step 2: **Insert the serial connector.** Insert the DB-9 connector of a serial device into the DB-9 connector on the uIBX-230-BT. See Figure 3-11.

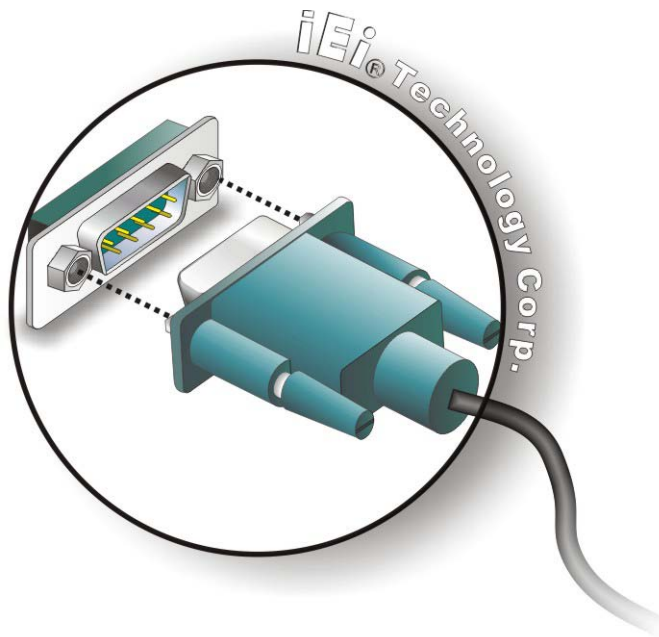

Figure 3-11: DB-9 Serial Port Connector

Step 3: **Secure the connector.** Secure the serial device connector to the external interface by tightening the two retention screws on either side of the connector.

3.8.4 USB Device Connection



NOTE:

User must install the USB 3.0 driver before connecting a USB device to the system or else the system may not recognize the connected device.

uIBX-230-BT Embedded System

There are three USB 2.0 connectors and one USB 3.0 connector on the uIBX-230-BT. To connect a USB device, please follow the instructions below.

Step 1: Locate the USB connectors. The locations of the USB connectors are shown in **Chapter 1**.

Step 2: Align the connectors. Align the USB device connector with one of the connectors on the uIBX-230-BT. See **Figure 3-12**.

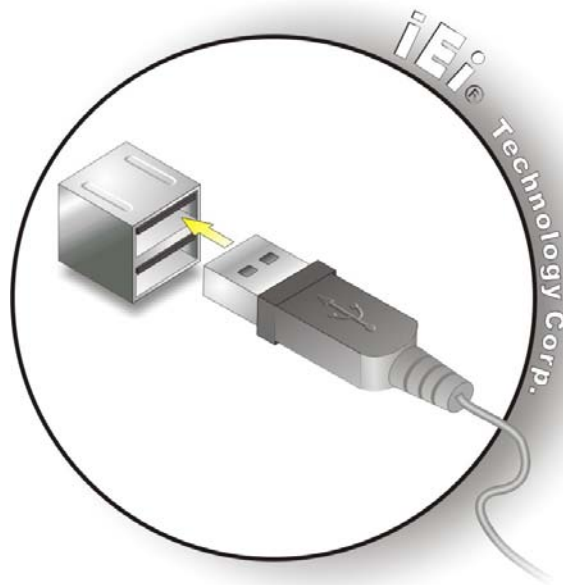

Figure 3-12: USB Device Connection

Step 3: Insert the device connector. Once aligned, gently insert the USB device connector into the onboard connector.

3.8.5 VGA Monitor Connection

The uIBX-230-BT has a single female DB-15 connector on the rear panel. The DB-15 connector is connected to a CRT or VGA monitor. To connect a monitor to the uIBX-230-BT, please follow the instructions below.

Step 1: Locate the female DB-15 connector. The location of the female DB-15 connector is shown in **Chapter 1**.

Step 2: Align the VGA connector. Align the male DB-15 connector on the VGA screen

cable with the female DB-15 connector on the uIBX-230-BT.

- Step 3:** **Insert the VGA connector.** Once the connectors are properly aligned with the insert the male connector from the VGA screen into the female connector on the uIBX-230-BT. See **Figure 3-13**.

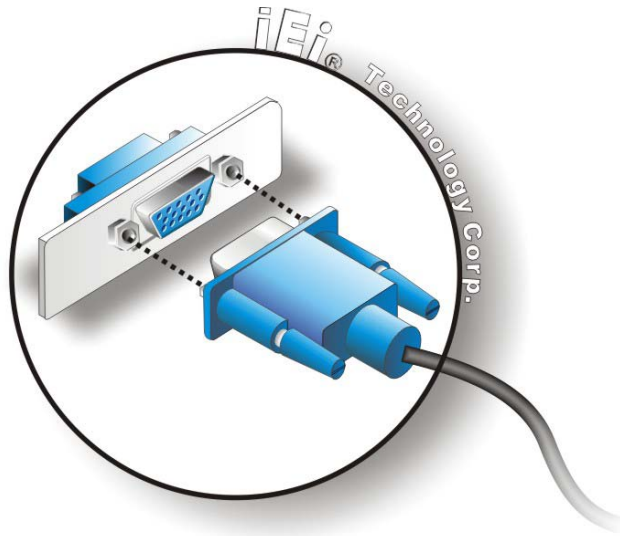

Figure 3-13: VGA Connector

- Step 4:** **Secure the connector.** Secure the DB-15 VGA connector from the VGA monitor to the external interface by tightening the two retention screws on either side of the connector.

Chapter

4

System Motherboard

4.1 Overview

This chapter details all the jumpers and connectors of the system motherboard.

4.1.1 Layout

The figures below show all the connectors and jumpers of the system motherboard. The Pin 1 locations of the on-board connectors are also indicated in the diagram below.

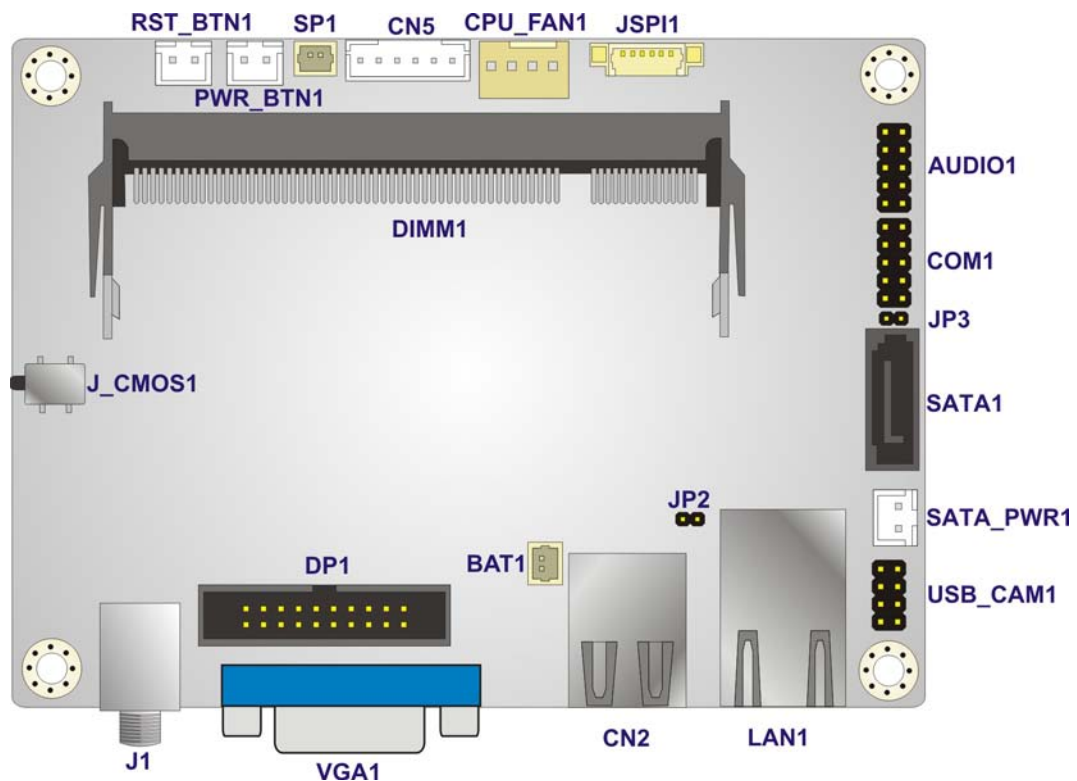

Figure 4-1: System Motherboard

4.2 Internal Peripheral Connectors

The table below shows a list of the internal peripheral interface connectors on the system motherboard. Pinouts of these connectors can be found in the following sections.

Connector	Type	Label
AT/ATX mode select switch	switch	J_ATX_AT1
Audio connector	10-pin header	AUDIO1

Battery connector	2-pin wafer	BAT1
BIOS FW connector	6-pin wafer	JSPI1
Buzzer connector	2-pin wafer	SP1
Clear CMOS button	button	J_CMOS1
CPU fan connector	4-pin wafer	CPU_FAN1
DDR3L SO-DIMM slot	DDR3L SO-DIMM slot	DIMM1
Display port connector	20-pin header	DP1
EC FW connector	2-pin wafer	JP3
Front panel connector	6-pin wafer	CN5
LAN LED connector	2-pin header	JP2
Power button connector	2-pin wafer	PWR_BTN1
Reset button connector	2-pin wafer	RST_BTN1
RS-232 serial port connector	10-pin header	COM1
SATA 3Gb/s drive connector	7-pin SATA connector	SATA1
SATA power connector	2-pin wafer	SATA_PWR1
USB 2.0 connector	8-pin header	USB_CAM1

Table 4-1: Peripheral Interface Connectors

4.2.1 AT/ATX Mode Select Switch

CN Label: **J_ATX_AT1**

CN Type: switch

CN Location: See **Figure 4-2**

CN Settings: See **Table 4-2**

The AT/ATX mode select switch specifies the systems power mode as AT or ATX. AT/ATX mode select switch settings are shown in **Table 4-2**.

Setting	Description
Short A-B	AT Mode
Short B-C	ATX Mode

Table 4-2: AT/ATX Mode Select Switch Settings

The location of the AT/ATX mode select switch is shown in **Figure 4-2** below.



Figure 4-2: AT/ATX Mode Select Switch Location

4.2.2 Audio Connector

- CN Label: **AUDIO1**
- CN Type: 10-pin header
- CN Location: See **Figure 4-3**
- CN Pinouts: See **Table 4-3**

The audio connector is connected to external audio devices including speakers and microphones for the input and output of audio signals to and from the system.

uIBX-230-BT Embedded System

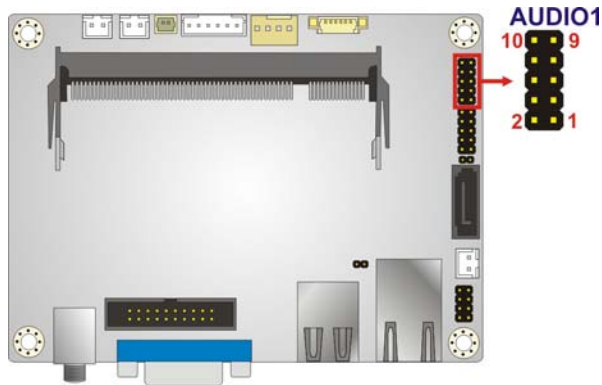

Figure 4-3: Audio Connector Location

Pin	Description	Pin	Description
1	LINE_OUTR	2	LINEIN_R
3	Analog_GND	4	Analog_GND
5	LINE_OUTL	6	LINEIN_L
7	Analog_GND	8	Analog_GND
9	LMIC1-R	10	LMIC1-L

Table 4-3: Audio Connector Pinouts

4.2.3 Battery Connector

- CN Label: **BAT1**
- CN Type: 2-pin wafer
- CN Location: See **Figure 4-4**
- CN Pinouts: See **Table 4-4**

The battery connector is connected to the system battery. The battery provides power to the system clock to retain the time when power is turned off.

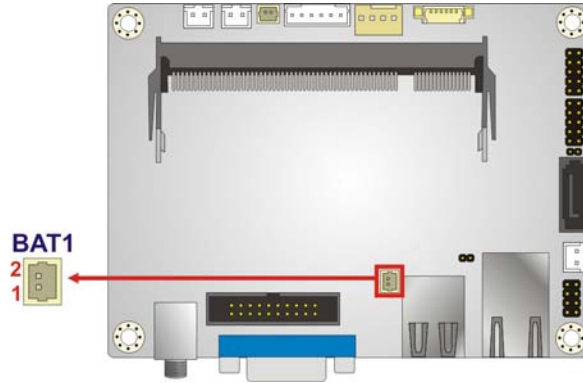

Figure 4-4: Battery Connector Location

Pin	Description	Pin	Description
1	VBATT	2	GND

Table 4-4: Battery Connector Pinouts

4.2.4 BIOS FW Connector

- CN Label: JSPII
- CN Type: 6-pin wafer
- CN Location: See **Figure 4-5**
- CN Pinouts: See **Table 4-5**

The BIOS FW connector is used for programming the BIOS.

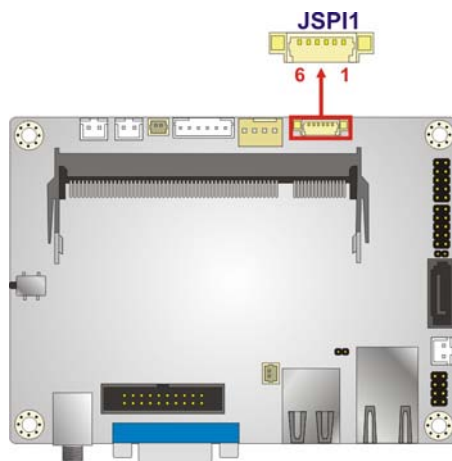

Figure 4-5: BIOS FW Connector Location

uIBX-230-BT Embedded System

Pin	Description	Pin	Description
1	+V1.8M_SPI_CON	2	SPI_CS
3	SPI_SO_SW	4	SPI_CLK_SW
5	SPI_SI_SW	6	GND

Table 4-5: BIOS FW Connector Pinouts

4.2.5 Buzzer Connector

CN Label:	SP1
CN Type:	2-pin wafer
CN Location:	See Figure 3-7
CN Pinouts:	See Table 4-6

The buzzer connector is connected to the buzzer.

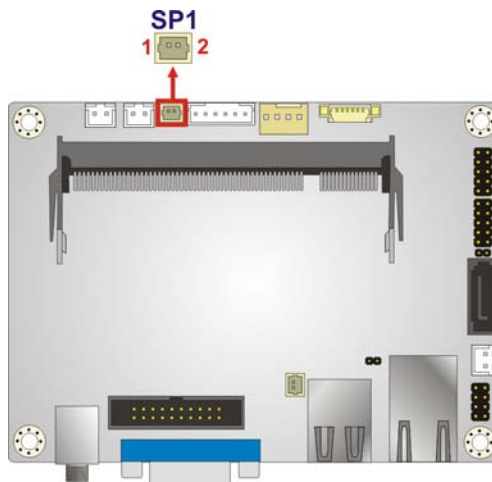

Figure 4-6: Buzzer Connector Location

Pin	Description	Pin	Description
1	Buzzer +	2	Buzzer -

Table 4-6: Buzzer Connector Pinouts

4.2.6 Clear CMOS Button

CN Label:	J_CMOS1
-----------	---------

- CN Type: button
- CN Location: See **Figure 3-6**
- CN Settings: See **Table 4-7**

If the uIBX-230-BT fails to boot due to improper BIOS settings, use the button to clear the CMOS data and reset the system BIOS information.

The clear CMOS button settings are shown in **Table 4-7**.

Setting	Description	
Open	Normal Operation	Default
Push	Clear CMOS Setup	

Table 4-7: Clear CMOS Button Settings

The location of the clear CMOS button is shown in **Figure 3-6**.

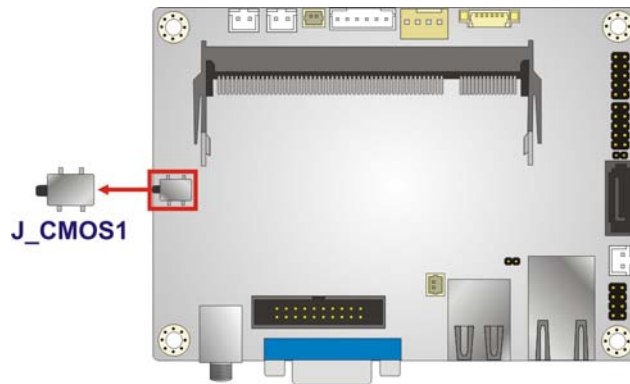

Figure 4-7: Clear CMOS Button Location

4.2.7 CPU Fan Connector

- CN Label: CPU_FAN1
- CN Type: 4-pin wafer
- CN Location: See **Figure 4-8**
- CN Pinouts: See **Table 4-8**

The fan connector attaches to a cooling fan.

uIBX-230-BT Embedded System

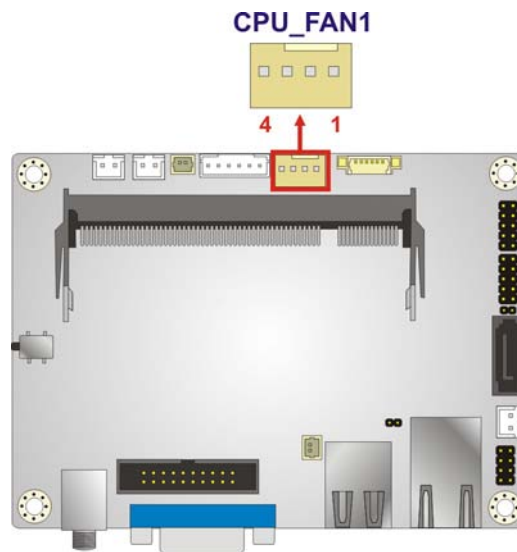

Figure 4-8: CPU Fan Connector Location

Pin	Description	Pin	Description
1	GND	2	+V12_FAN
3	FANIO1_EC	4	FANOUT1_EC

Table 4-8: CPU Fan Connector Pinouts

4.2.8 DDR3L SO-DIMM Slot

- CN Label: DIMM1
- CN Type: DDR3L SO-DIMM slot
- CN Location: See **Figure 4-9**

The DDR3L SO-DIMM slot is for DDR3L SO-DIMM memory module.

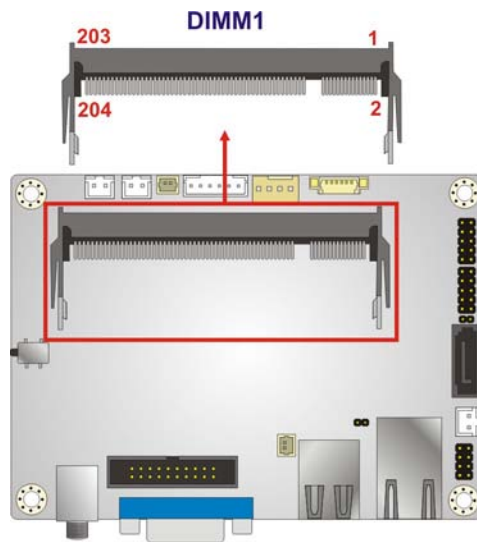

Figure 4-9: DDR3L SO-DIMM Slot Location

4.2.9 Display Port Connector

CN Label:	DP1
CN Type:	20-pin box header
CN Location:	See Figure 4-10
CN Pinouts:	See Table 4-9

The display port connector provides flexible display function that supports VGA, DVI, LVDS, HDMI and DisplayPort via the display port convert board.

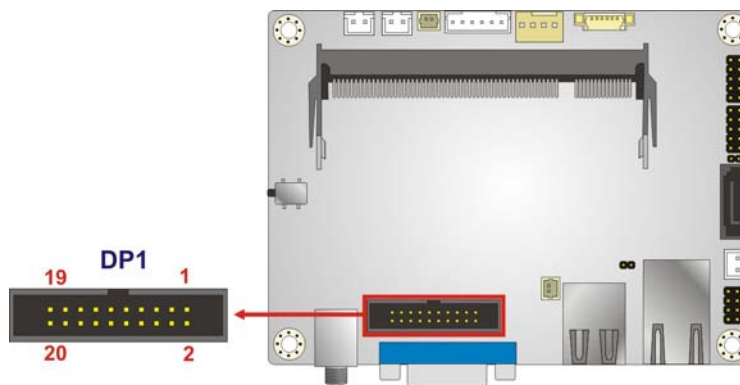

Figure 4-10: Display Port Connector Location

uIBX-230-BT Embedded System

Pin	Description	Pin	Description
1	DDI1_HPDI#	2	DPD_AUX_CTRL_P2
3	GND	4	DPD_AUX_CTRL_N2
5	AUX_CTRL_DET_D	6	GND
7	GND	8	DPD_OB_LANE2_P
9	DPD_OB_LANE3_P	10	DPD_OB_LANE2_N
11	DPD_OB_LANE3_N	12	GND
13	GND	14	DPD_OB_LANE0_P
15	DPD_OB_LANE1_P	16	DPD_OB_LANE0_N
17	DPD_OB_LANE1_N	18	GND
19	VCC	20	NC

Table 4-9: Display Port Connector Pinouts

4.2.10 EC FW Connector

CN Label: JP3
 CN Type: 2-pin header
 CN Location: See **Figure 4-11**
 CN Pinouts: See **Table 4-10**

The EC FW connector is used for programming the EC.

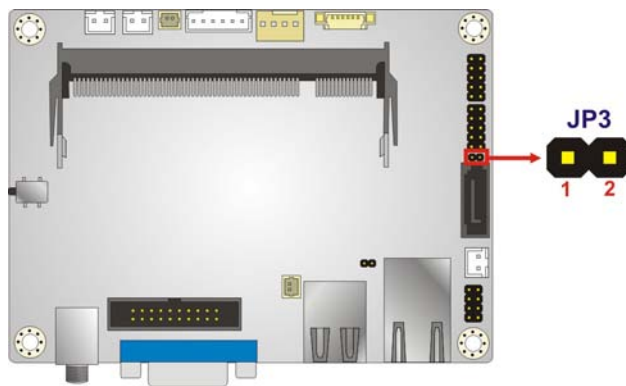

Figure 4-11: EC FW Connector Location

Pin	Description	Pin	Description
1	SMB_CLK_FW	2	SMB_DATA_FW

Pin	Description	Pin	Description
-----	-------------	-----	-------------

Table 4-10: EC FW Connector Pinouts

4.2.11 Front Panel Connector

- CN Label: CN5
- CN Type: 6-pin wafer
- CN Location: See **Figure 4-12**
- CN Pinouts: See **Table 4-11**

The front panel connector connects to the indicator LEDs on the system front panel.

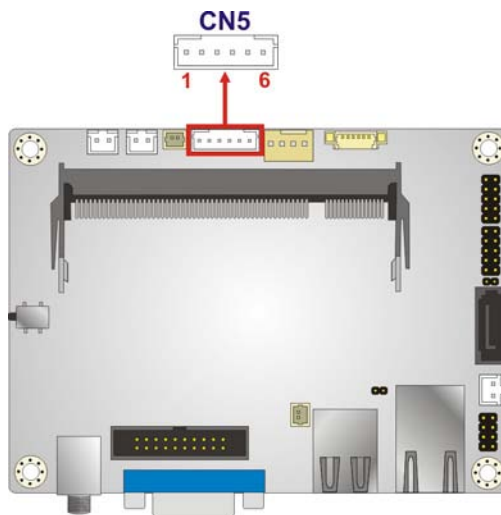

Figure 4-12: Front Panel Connector Location

Pin	Description	Pin	Description
1	+V5S	2	GND
3	PWR_LED+	4	PWR_LED-
5	HDD_LED+	6	HDD_LED-

Table 4-11: Front Panel Connector Pinouts

4.2.12 LAN LED Connector

- CN Label: JP2
- CN Type: 2-pin header

uIBX-230-BT Embedded System

CN Location: See **Figure 4-13**

CN Pinouts: See **Table 4-12**

The LAN LED connectors connect to the LAN link LEDs on the system.

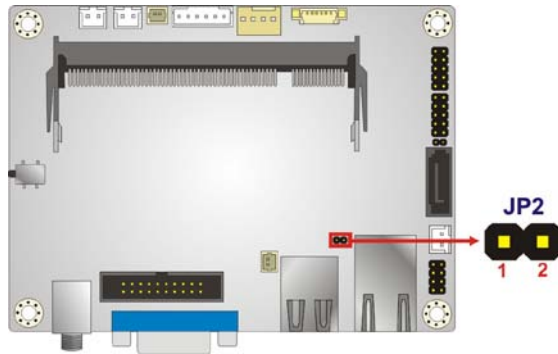

Figure 4-13: LAN LED Connector Location

Pin	Description	Pin	Description
1	VCC	2	L1_LINK_ACT-

Table 4-12: LAN LED Connector Pinouts

4.2.13 Power Button Connector

CN Label: PWR_BTN1

CN Type: 2-pin wafer

CN Location: See **Figure 4-14**

CN Pinouts: See **Table 4-13**

The power button connector is connected to a power switch on the system chassis to enable users to turn the system on and off.

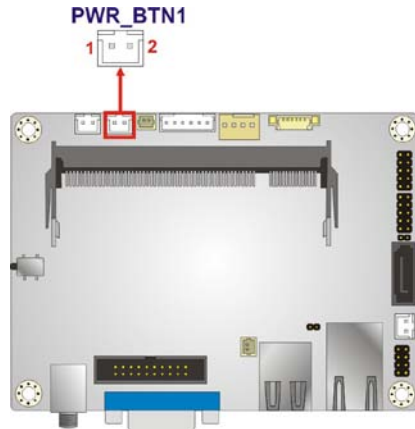

Figure 4-14: Power Button Connector Location

Pin	Description
1	PWRBTN_SW#
2	GND

Table 4-13: Power Button Connector Pinouts

4.2.14 Reset Button Connector

- CN Label: RST_BTN1
- CN Type: 2-pin wafer
- CN Location: See **Figure 4-15**
- CN Pinouts: See **Table 4-14**

The reset button connector is connected to a reset switch on the system chassis to enable users to reboot the system when the system is turned on.

uIBX-230-BT Embedded System

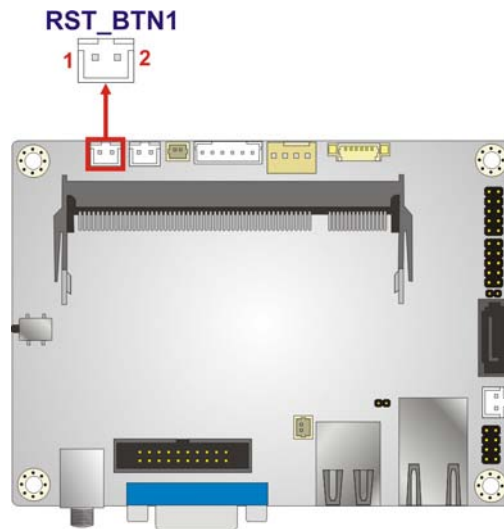

Figure 4-15: Reset Button Connector Location

Pin	Description
1	PM_SYSRST_R#
2	GND

Table 4-14: Reset Button Connector Pinouts

4.2.15 RS-232 Serial Port Connector

- CN Label: COM1
- CN Type: 10-pin header
- CN Location: See **Figure 4-16**
- CN Pinouts: See **Table 4-15**

The serial connector provides RS-232 connection.

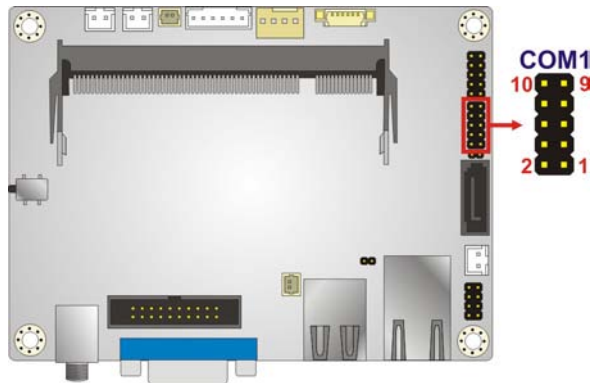

Figure 4-16: RS-232 Serial Port Connector Location

Pin	Description	Pin	Description
1	-NDCD1	2	-NDSR1
3	NSIN1	4	-NRTS1
5	NSOUT1	6	-NCTS1
7	-NDTR1	8	-XRI1
9	GND	10	GND

Table 4-15: RS-232 Serial Port Connector Pinouts

4.2.16 SATA 3Gb/s Drive Connector

- CN Label: **SATA1**
- CN Type: 7-pin SATA connector
- CN Location: See **Figure 4-17**

The SATA 3Gb/s drive connector is connected to a SATA 3Gb/s drive. The SATA 3Gb/s drive transfers data at speeds as high as 3Gb/s.

uIBX-230-BT Embedded System

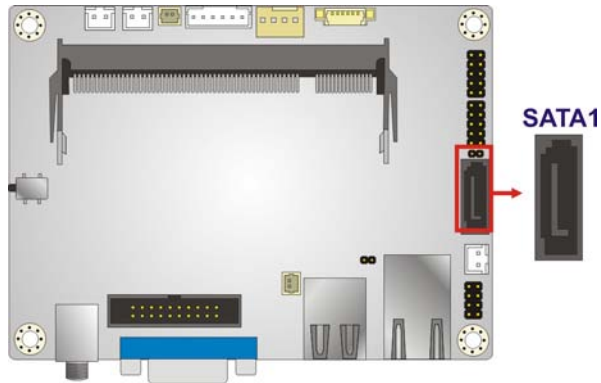

Figure 4-17: SATA 3Gb/s Drive Connector Location

4.2.17 SATA Power Connector

- CN Label: **SATA_PWR1**
- CN Type: 2-pin wafer
- CN Location: See **Figure 4-18**
- CN Pinouts: See **Table 4-16**

The SATA power connector provides +5V power output to the SATA connector.

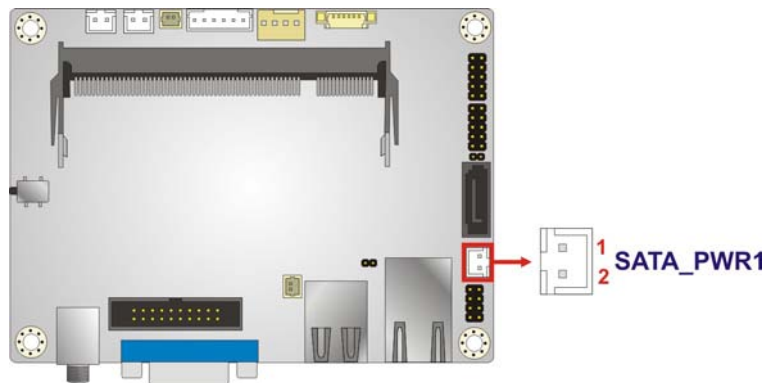

Figure 4-18: SATA Power Connector Location

Pin	Description
1	+5V
2	GND

Table 4-16: SATA Power Connector Pinouts

4.2.18 USB Connector

- CN Label: **USB2_CAM1**
- CN Type: 8-pin header
- CN Location: See **Figure 4-19**
- CN Pinouts: See **Table 4-17**

The USB connector provides two USB 2.0 ports by dual-port USB cable.

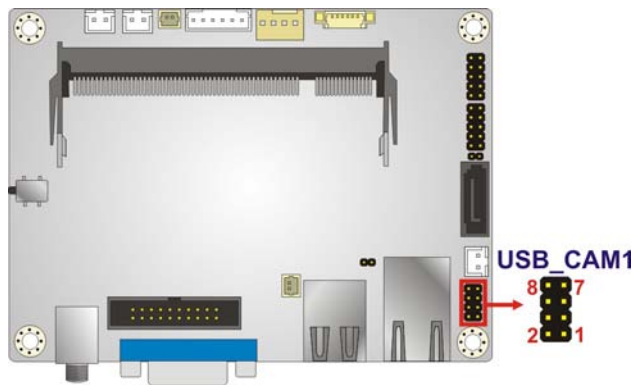

Figure 4-19: USB Connector Location

Pin	Description	Pin	Description
1	VCC	2	GND
3	DATA2_N	4	DATA3_P
5	DATA2_P	6	DATA3_N
7	GND	8	VCC

Table 4-17: USB Connector Pinouts

4.3 External Interface Panel Connectors

The table below shows a list of the external interface panel connectors on the system motherboard. Pinouts of these connectors can be found in the following sections.

Connector	Type	Label
12V DC IN Connector	DC power jack	J1

uIBX-230-BT Embedded System

LAN connector	RJ-45	LAN1
USB 2.0 & USB 3.0 connector	USB 2.0 & USB 3.0	CN2
VGA Connector	15-pin female	VGA1

Table 4-18: Rear Panel Connectors

4.3.1 LAN Connector

- CN Label: LAN1
- CN Type: RJ-45
- CN Location: See **Figure 4-1**
- CN Pinouts: See **Figure 3-11** and **Table 4-19**

The LAN connector connects to a local network.

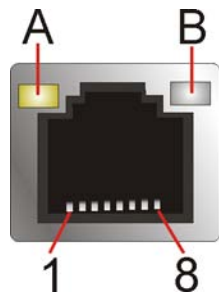

Figure 4-20: LAN Connector

Pin	Description	Pin	Description
1	MDIA3-	5	MDIA2+
2	MDIA3+	6	MDIA1+
3	MDIA1-	7	MDIA0-
4	MDIA2-	8	MDIA0+

Table 4-19: LAN Pinouts

LED	Description	LED	Description
A	on: linked blinking: data is being sent/received	B	off: 10 Mb/s green: 100 Mb/s orange: 1000 Mb/s

Table 4-20: Connector LEDs

4.3.2 Power Connector

- CN Label: J1
- CN Type: 12V DC IN
- CN Location: See **Figure 4-1**
- CN Pinouts: See **Table 4-21**

The power connector supports 12V DC power input.

Pin	Description	Pin	Description
1	VCC	2	GND
3	GND		

Table 4-21: Power Connector Pinouts

4.3.3 USB Connectors

- CN Label: CN2
- CN Type: USB 2.0 & USB 3.0 ports
- CN Location: See **Figure 4-1**
- CN Pinouts: See **Table 4-21**

The uIBX-230-BT has one external USB 2.0 port and one external USB 3.0 port. The USB connector can be connected to a USB device. The pinouts of USB 2.0 port & USB 3.0 connectors are shown below.

Pin	Description	Pin	Description
1	VCC_USB3_01	8	USB3P0_TXDN1
2	USB2P0_DM1_L	9	USB3P0_TXDP1
3	USB2P0_DP1_L	10	VCC_USB3_01
4	GND	11	DATA1_N
5	USB3P0_RXDN1	12	DATA1_P
6	USB3P0_RXDP1	13	GND
7	GND		

Table 4-22: USB 2.0 & USB 3.0 Port Pinouts

uIBX-230-BT Embedded System

4.3.1 VGA Connector

- CN Label: VGA1
- CN Type: 15-pin female (VGA)
- CN Location: See **Figure 4-1**
- CN Pinouts: See **Figure 4-21** and **Table 4-23**

The VGA port connects to a monitor that accepts a standard VGA input.

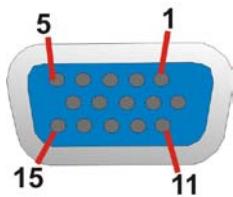

Figure 4-21: VGA Connector

Pin	Description	Pin	Description
1	Red	2	Green
3	Blue	4	NC
5	GND	6	GND
7	GND	8	GND
9	VGAVCC	10	HOTPLUG
11	NC	12	DDCDAT
13	HSYNC	14	VSYNC
15	DDCCLK		

Table 4-23: VGA Connector Pinouts

Chapter

5

BIOS

5.1 Introduction

The BIOS is programmed onto the BIOS chip. The BIOS setup program allows changes to certain system settings. This chapter outlines the options that can be changed.



NOTE:

Some of the BIOS options may vary throughout the life cycle of the product and are subject to change without prior notice.

5.1.1 Starting Setup

The UEFI BIOS is activated when the computer is turned on. The setup program can be activated in one of two ways.

1. Press the **DELETE** or **F2** key as soon as the system is turned on or
2. Press the **DELETE** or **F2** key when the “**Press Del to enter SETUP**” message appears on the screen.

If the message disappears before the **DELETE** or **F2** key is pressed, restart the computer and try again.

5.1.2 Using Setup

Use the arrow keys to highlight items, press **ENTER** to select, use the PageUp and PageDown keys to change entries, press **F1** for help and press **ESC** to quit. Navigation keys are shown in.

Key	Function
Up arrow	Move to previous item
Down arrow	Move to next item
Left arrow	Move to the item on the left hand side
Right arrow	Move to the item on the right hand side
+	Increase the numeric value or make changes

Key	Function
-	Decrease the numeric value or make changes
F1 key	General help, only for Status Page Setup Menu and Option Page Setup Menu
F2 key	Load previous values.
F3 key	Load optimized defaults
F4 key	Save changes and Exit BIOS
Esc key	Main Menu – Quit and not save changes into CMOS Status Page Setup Menu and Option Page Setup Menu -- Exit current page and return to Main Menu

Table 5-1: BIOS Navigation Keys

5.1.3 Getting Help

When **F1** is pressed a small help window describing the appropriate keys to use and the possible selections for the highlighted item appears. To exit the Help Window press **ESC** or the **F1** key again.

5.1.4 Unable to Reboot after Configuration Changes

If the computer cannot boot after changes to the system configuration is made, CMOS defaults. Use the jumper described in Chapter 3.

5.1.5 BIOS Menu Bar

The **menu bar** on top of the BIOS screen has the following main items:

- Main – Changes the basic system configuration.
- Advanced – Changes the advanced system settings.
- Chipset – Changes the chipset settings.
- Security – Sets User and Supervisor Passwords.
- Boot – Changes the system boot configuration.
- Save & Exit – Selects exit options and loads default settings

uIBX-230-BT Embedded System

The following sections completely describe the configuration options found in the menu items at the top of the BIOS screen and listed above.

5.2 Main

The **Main** BIOS menu (**BIOS Menu 1**) appears when the **BIOS Setup** program is entered. The **Main** menu gives an overview of the basic system information.

```

Aptio Setup Utility - Copyright (C) 2013 American Megatrends, Inc.
Main  Advanced  Chipset  Security  Boot  Save & Exit

BIOS Information
BIOS Vendor                American Megatrends
Core Version               5.009
Compliancy                 UEFI 2.3; PI 1.2
Project Version            SEH0AR10.ROM
Build Date and Time       09/18/2014 09:34:25

iWDD Vendor                iEi
iWDD Version               SEH0ER10.bin

Memory Information
Total Memory               2048 MB(LPDDR3)

TXE Information
Sec RC Version             00.05.00.00
TXE FW Version             01.00.02.1060

System Date                [Fri 11/07/2014]
System Time                [19:43:27]

Access Level                Administrator

Set the Date. Use Tab to
switch between Data
elements.

-----
<->: Select Screen
^ v: Select Item
Enter>Select
+/-: Change Opt.
F1:  General Help
F2:  Previous Values
F3:  Optimized Defaults
F4:  Save & Exit
ESC: Exit

Version 2.16.1242. Copyright (C) 2013 American Megatrends, Inc.

```

BIOS Menu 1: Main

The Main menu lists the following system details:

- BIOS Information
- iWDD Information
- Memory Information
- TXE Information

The System Overview field also has two user configurable fields:

➔ System Date [xx/xx/xx]

Use the **System Date** option to set the system date. Manually enter the day, month and year.

➔ System Time [xx:xx:xx]

Use the **System Time** option to set the system time. Manually enter the hours, minutes and seconds.

5.3 Advanced

Use the **Advanced** menu (**BIOS Menu 2**) to configure the CPU and peripheral devices through the following sub-menus:



WARNING!

Setting the wrong values in the sections below may cause the system to malfunction. Make sure that the settings made are compatible with the hardware.

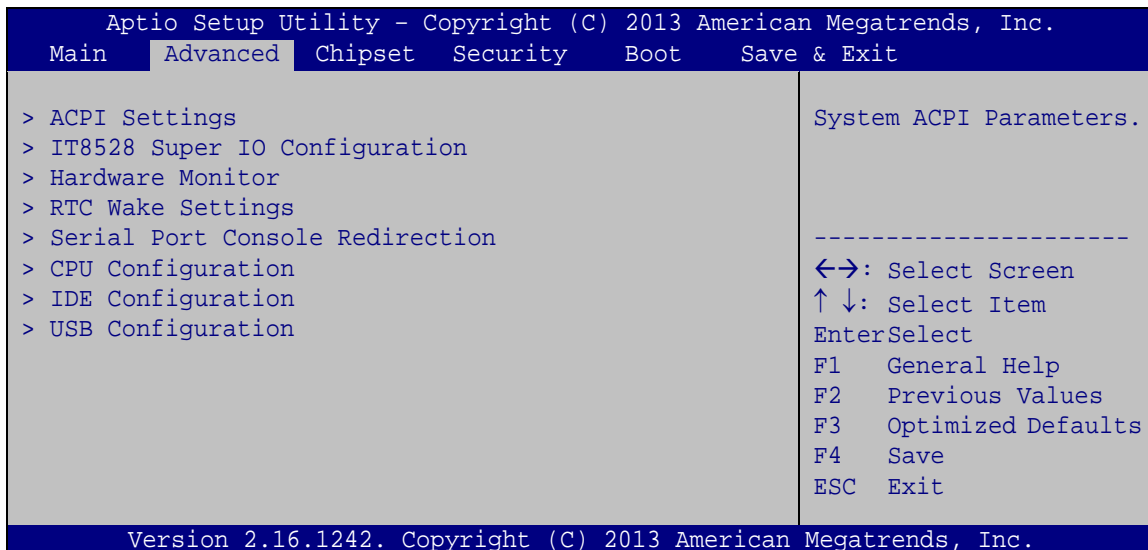

BIOS Menu 2: Advanced

uIBX-230-BT Embedded System

5.3.1 ACPI Settings

The **ACPI Settings** menu (**BIOS Menu 3**) configures the Advanced Configuration and Power Interface (ACPI) options.

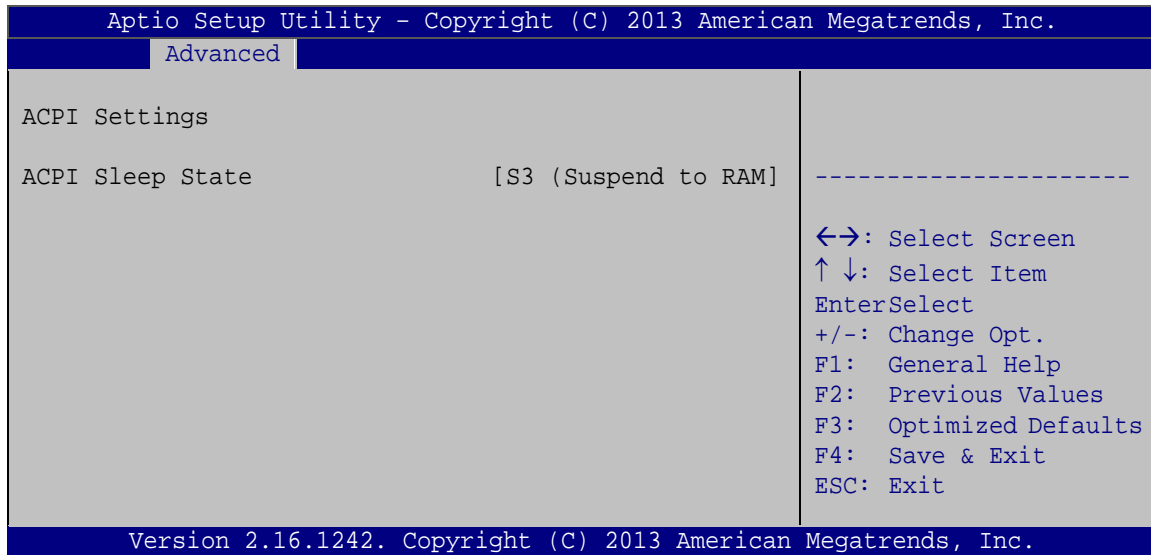

BIOS Menu 3: ACPI Configuration

→ ACPI Sleep State [S3 only (Suspend to RAM)]

The fields in **ACPI Sleep State** option cannot be changed.

- **Suspend Disabled** Disable the suspend function.
- **S3 (Suspend to DEFAULT RAM)** The caches are flushed and the CPU is powered off. Power to the RAM is maintained. The computer returns slower to a working state, but more power is saved.

5.3.2 IT8528 Super IO Configuration

Use the **IT8528 Super IO Configuration** menu (**BIOS Menu 4**) to set or change the configurations for the serial ports.

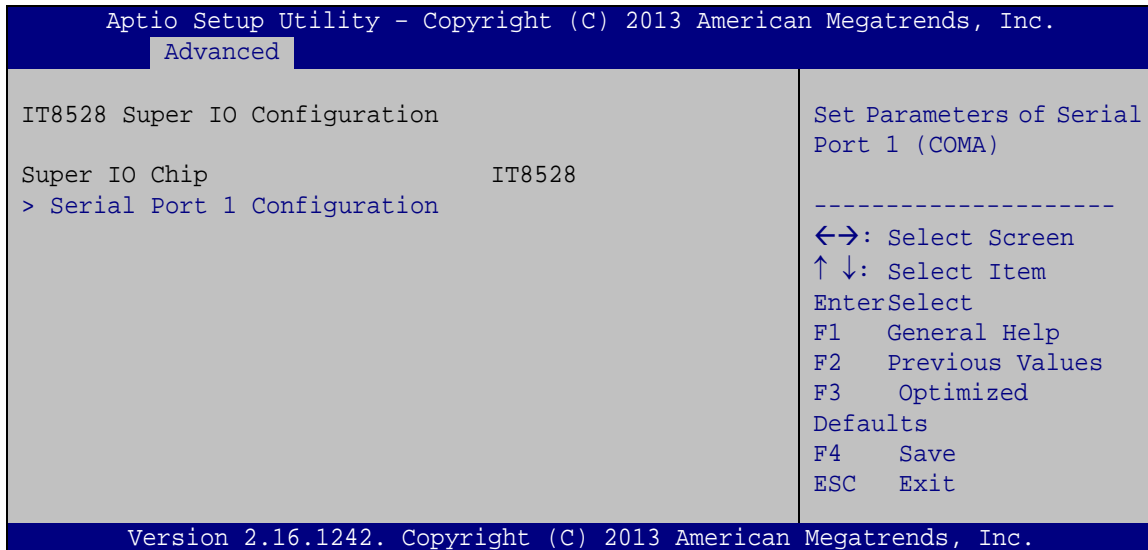

BIOS Menu 4: Super IO Configuration

5.3.2.1 Serial Port 1 Configuration

Use the **Serial Port 1 Configuration** menu (**BIOS Menu 5**) to configure the serial port 1.

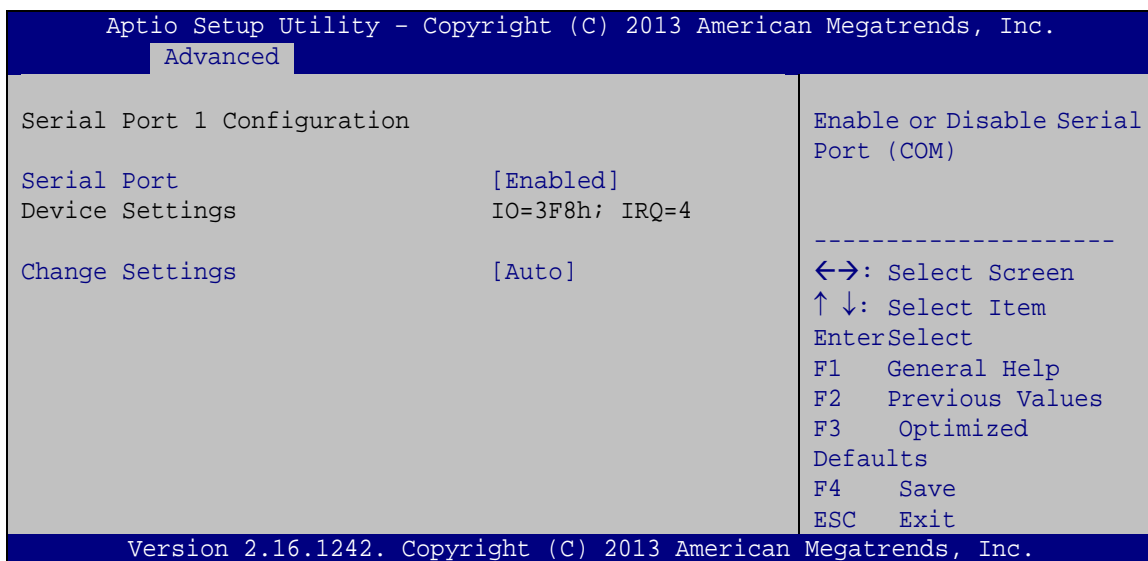

BIOS Menu 5: Serial Port 1 Configuration Menu

uIBX-230-BT Embedded System

→ Serial Port [Enabled]

Use the **Serial Port** option to enable or disable the serial port.

- **Disabled** Disable the serial port
- **Enabled** **DEFAULT** Enable the serial port

→ Change Settings [Auto]

Use the **Change Settings** option to change the serial port IO port address and interrupt address.

- **Auto** **DEFAULT** The serial port IO port address and interrupt address are automatically detected.
- **IO=3F8h; IRQ=4** Serial Port I/O port address is 3F8h and the interrupt address is IRQ4
- **IO=3F8h; IRQ=3, 4,5,6,7,9,10,11,12** Serial Port I/O port address is 3F8h and the interrupt address is IRQ3,4,5,6,7,9,10,11,12
- **IO=2F8h; IRQ=3, 4,5,6,7,9,10,11,12** Serial Port I/O port address is 2F8h and the interrupt address is IRQ3,4,5,6,7,9,10,11,12
- **IO=3E8h; IRQ=3, 4,5,6,7,9,10,11,12** Serial Port I/O port address is 3E8h and the interrupt address is IRQ3,4,5,6,7,9,10,11,12
- **IO=2E8h; IRQ=3, 4,5,6,7,9,10,11,12** Serial Port I/O port address is 2E8h and the interrupt address is IRQ3,4,5,6,7,9,10,11,12

5.3.3 Hardware Monitor

The Hardware Monitor menu (**BIOS Menu 6**) contains the fan configuration submenus and displays operating temperature, fan speeds and system voltages.

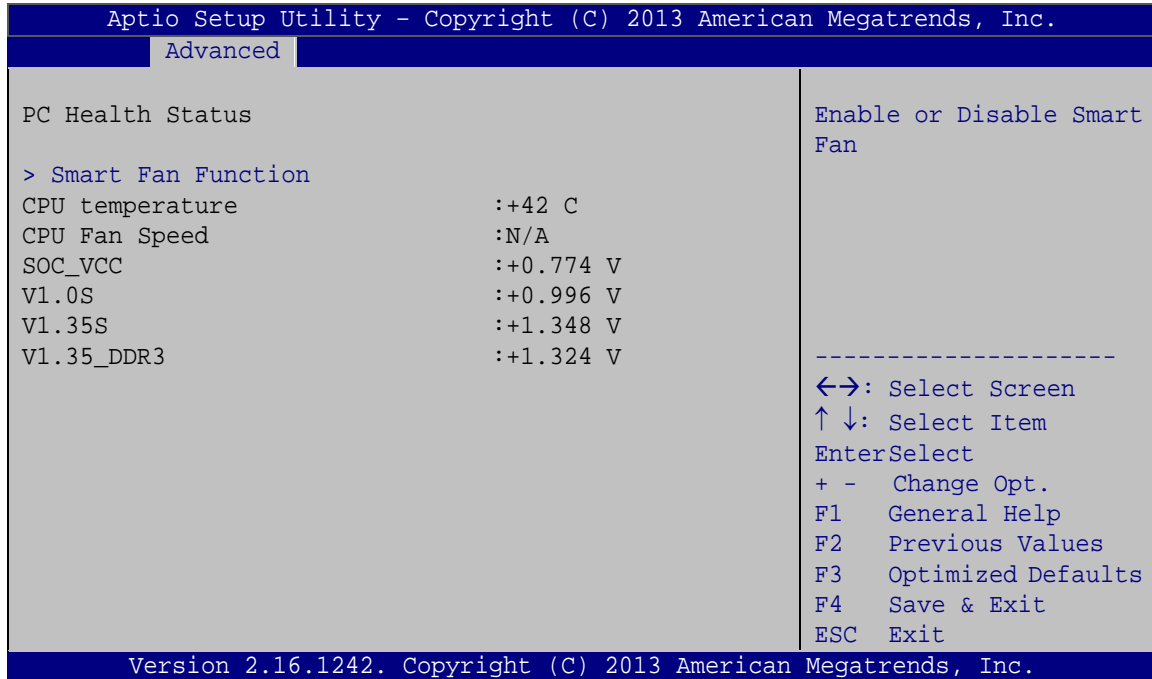

BIOS Menu 6: Hardware Monitor

➔ PC Health Status

The following system parameters and values are shown. The system parameters that are monitored are:

- System Temperatures:
 - CPU Temperature
- Fan Speed:
 - CPU Fan Speed
- Voltages:
 - SOC_VCC
 - V1.0S
 - V1.35S
 - V1.35_DDR3

5.3.3.1 Smart Fan Mode Configuration

Use the **Smart Fan Mode Configuration submenu (BIOS Menu 7)** to configure fan temperature and speed settings.

uIBX-230-BT Embedded System

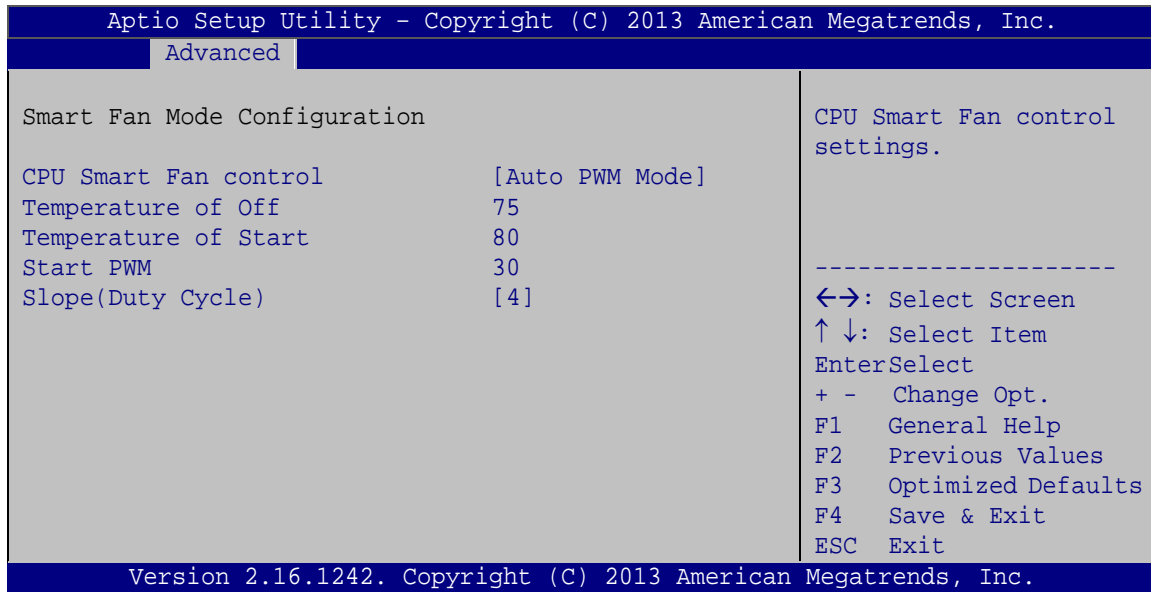

BIOS Menu 7: Smart Fan Mode Configuration

→ CPU Smart Fan control [Auto PWM Mode]

Use the **CPU Smart Fan control** BIOS option to configure the CPU Smart Fan.

- **Full Mode** Fan is on all the time
- **Manual PWM Mode** The fan spins at the speed set in the manual PWM setting
- **Auto PWM Mode** **DEFAULT** The fan adjusts its speed using these settings:
 - Temperature of Off
 - Temperature of Start
 - Start PWM
 - Slope (Duty Cycle)

→ Temperature of Off [75]



WARNING:

Setting this value too high may cause the fan to speed up only when

the CPU is at a very high temperature and therefore cause the system to be damaged.

The **Temperature of Off** option can only be set if the **CPU Smart Fan control** option is set to **Auto Mode**. If the CPU temperature is lower than **Temperature of Off**, the fan speed change to be lowest. To set a value, select the **Temperature of Off** option and enter a decimal number between 0 and 127. The temperature range is specified below.

- Minimum Value: 0°C
- Maximum Value: 127°C

→ Temperature of Start [80]



WARNING:

Setting this value too high may cause the fan to rotate at full speed only when the CPU is at a very high temperature and therefore cause the system to be damaged.

The **Temperature of Start** option can only be set if the **CPU Smart Fan control** option is set to **Auto Mode**. If the CPU temperature is between **Temperature of Off** and **Temperature of Start**, the fan speed change to be **Start PWM**. To set a value, select the **Temperature of Start** option and enter a decimal number between 0 and 127. The temperature range is specified below.

- Minimum Value: 0°C
- Maximum Value: 127°C

→ Start PWM [30]

The **Start PWM** option can only be set if the **CPU Smart Fan control** option is set to **Auto Mode**. Use the **Start PWM** option to set the PWM start value. To set a value, select the **Start PWM** option and enter a decimal number between 0 and 100. The temperature range is specified below.

uIBX-230-BT Embedded System

- Minimum Value: 0
- Maximum Value: 100

→ Slope (Duty Cycle) [4]

The **Slope (Duty Cycle)** option can only be set if the **CPU Smart Fan control** option is set to **Auto Mode**. Use the **Slope (Duty Cycle)** option to select the linear rate at which the PWM mode increases with respect to an increase in temperature. A list of available options is shown below:

- 0
- 1
- 2
- 4
- 8
- 16

5.3.4 RTC Wake Settings

The **RTC Wake Settings** menu (**BIOS Menu 8**) configures RTC wake event.

```

Aptio Setup Utility - Copyright (C) 2013 American Megatrends, Inc.
  Advanced
Wake system with Fixed Time      [Disabled]
                                   Enable or disable System
                                   wake on alarm event. When
                                   enabled, System will
                                   wake on the
                                   date::hr::min::sec
                                   specified
                                   -----
                                   ←→: Select Screen
                                   ↑↓: Select Item
                                   Enter>Select
                                   F1   General Help
                                   F2   Previous Values
                                   F3   Optimized Defaults
                                   F4   Save
                                   ESC  Exit
Version 2.16.1242. Copyright (C) 2013 American Megatrends, Inc.

```

BIOS Menu 8: RTC Wake Settings

→ Wake system with Fixed Time [Disabled]

Use the **Wake system with Fixed Time** option to enable or disable the system wake on alarm event.

→ **Disabled** **DEFAULT** The real time clock (RTC) cannot generate a wake event

→ **Enabled** If selected, the **Wake up every day** option appears allowing you to enable to disable the system to wake every day at the specified time. Besides, the following options appear with values that can be selected:

Wake up date

Wake up hour

Wake up minute

Wake up second

After setting the alarm, the computer turns itself on from a suspend state when the alarm goes off.

5.3.5 Serial Port Console Redirection

The **Serial Port Console Redirection** menu (**BIOS Menu 9**) allows the console redirection options to be configured. Console redirection allows users to maintain a system remotely by re-directing keyboard input and text output through the serial port.

uIBX-230-BT Embedded System

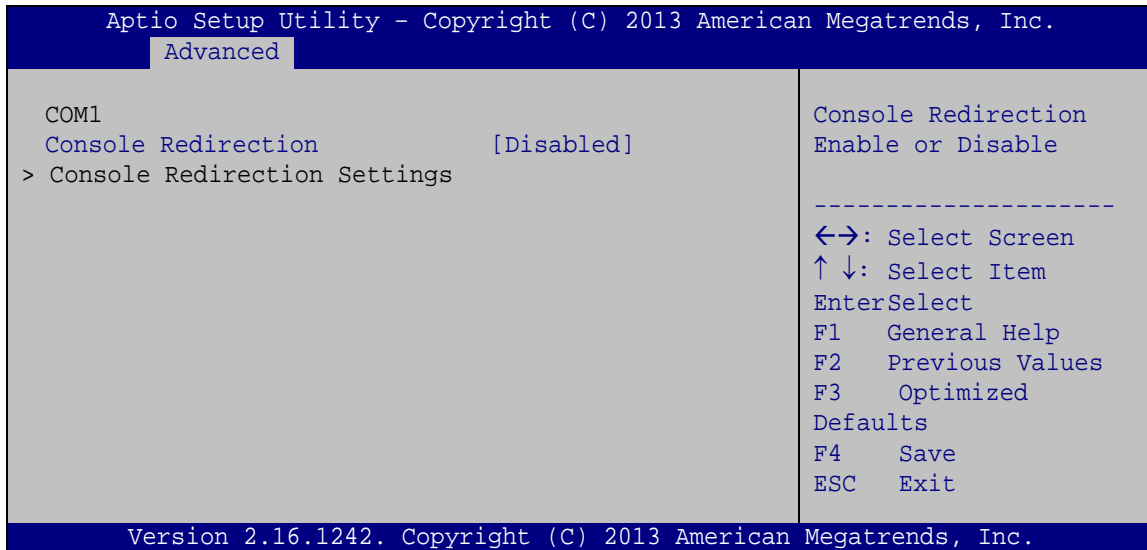

BIOS Menu 9: Serial Port Console Redirection

→ Console Redirection [Disabled]

Use **Console Redirection** option to enable or disable the console redirection function.

→ **Disabled** **DEFAULT** Disabled the console redirection function

→ **Enabled** Enabled the console redirection function

5.3.5.1 Console Redirection Settings

The **Console Redirection Settings** menu (**BIOS Menu 10**) allows the console redirection options to be configured. The option is active when Console Redirection option is enabled.

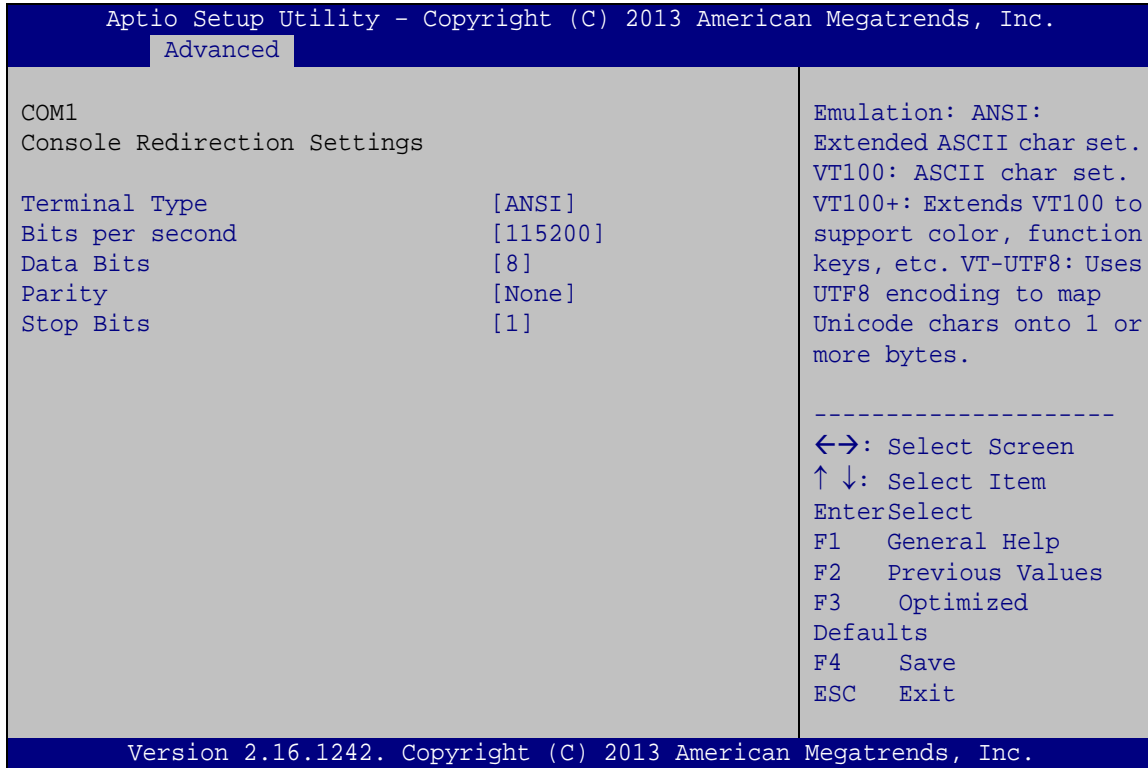

BIOS Menu 10: Console Redirection Settings

➔ Terminal Type [ANSI]

Use the **Terminal Type** option to specify the remote terminal type.

- ➔ **VT100** The target terminal type is VT100
- ➔ **VT100+** The target terminal type is VT100+
- ➔ **VT-UTF8** The target terminal type is VT-UTF8
- ➔ **ANSI** **DEFAULT** The target terminal type is ANSI

➔ Bits per second [115200]

Use the **Bits per second** option to specify the serial port transmission speed. The speed must match the other side. Long or noisy lines may require lower speeds.

- ➔ **9600** Sets the serial port transmission speed at 9600.
- ➔ **19200** Sets the serial port transmission speed at 19200.

uIBX-230-BT Embedded System

- ➔ **38400** Sets the serial port transmission speed at 38400.
- ➔ **57600** Sets the serial port transmission speed at 57600.
- ➔ **115200** **DEFAULT** Sets the serial port transmission speed at 115200.

➔ Data Bits [8]

Use the **Data Bits** option to specify the number of data bits.

- ➔ **7** Sets the data bits at 7.
- ➔ **8** **DEFAULT** Sets the data bits at 8.

➔ Parity [None]

Use the **Parity** option to specify the parity bit that can be sent with the data bits for detecting the transmission errors.

- ➔ **None** **DEFAULT** No parity bit is sent with the data bits.
- ➔ **Even** The parity bit is 0 if the number of ones in the data bits is even.
- ➔ **Odd** The parity bit is 0 if the number of ones in the data bits is odd.
- ➔ **Mark** The parity bit is always 1. This option does not provide error detection.
- ➔ **Space** The parity bit is always 0. This option does not provide error detection.

➔ Stop Bits [1]

Use the **Stop Bits** option to specify the number of stop bits used to indicate the end of a serial data packet. Communication with slow devices may require more than 1 stop bit.

- ➔ **1** **DEFAULT** Sets the number of stop bits at 1.
- ➔ **2** Sets the number of stop bits at 2.

5.3.6 CPU Configuration

Use the **CPU Configuration** menu (**BIOS Menu 5**) to view detailed CPU specifications and configure the CPU.

```

Aptio Setup Utility - Copyright (C) 2013 American Megatrends, Inc.
  Advanced
CPU Configuration
Intel(R) Celeron(R) CPU N2930 @ 1.83GHz
CPU Signature                30678
Microcode Patch              809
Max CPU Speed                1830 MHz
Min CPU Speed                500 MHz
Processor Cores              4
Intel HT Technology          Not Supported
Intel VT-x Technology        Supported

L1 Data Cache                24 KB x 4
L1 Code Cache                32 KB x 4
L2 Cache                     1024 KB x 2
L3 Cache                     Not Present
CPU Speed                    1834 MHz
64-bit                       Supported

Intel Virtualization Technology [Enabled]
EIST                          [Enabled]

When enabled, a VMM can utilize the additional hardware capabilities provided by Vanderpool Technology.

-----
<->: Select Screen
^ v: Select Item
Enter>Select
F1   General Help
F2   Previous Values
F3   Optimized
Defaults
F4   Save
ESC  Exit

Version 2.16.1242. Copyright (C) 2013 American Megatrends, Inc.
  
```

BIOS Menu 11: CPU Configuration

➔ Intel® Virtualization Technology [Disabled]

Use the **Intel® Virtualization Technology** option to enable or disable virtualization on the system. When combined with third party software, Intel Virtualization technology allows several OSs to run on the same system at the same time.

➔ **Disabled** **DEFAULT** Disables Intel Virtualization Technology.

➔ **Enabled** Enables Intel Virtualization Technology.

➔ EIST [Enabled]

Use the **EIST** option to enable or disable the Intel Speed Step Technology.

uIBX-230-BT Embedded System

- ➔ **Disabled** Disables the Intel Speed Step Technology.
- ➔ **Enabled** **DEFAULT** Enables the Intel Speed Step Technology.

5.3.7 IDE Configuration

Use the **IDE Configuration** menu (**BIOS Menu 12**) to change and/or set the configuration of the SATA devices installed in the system.

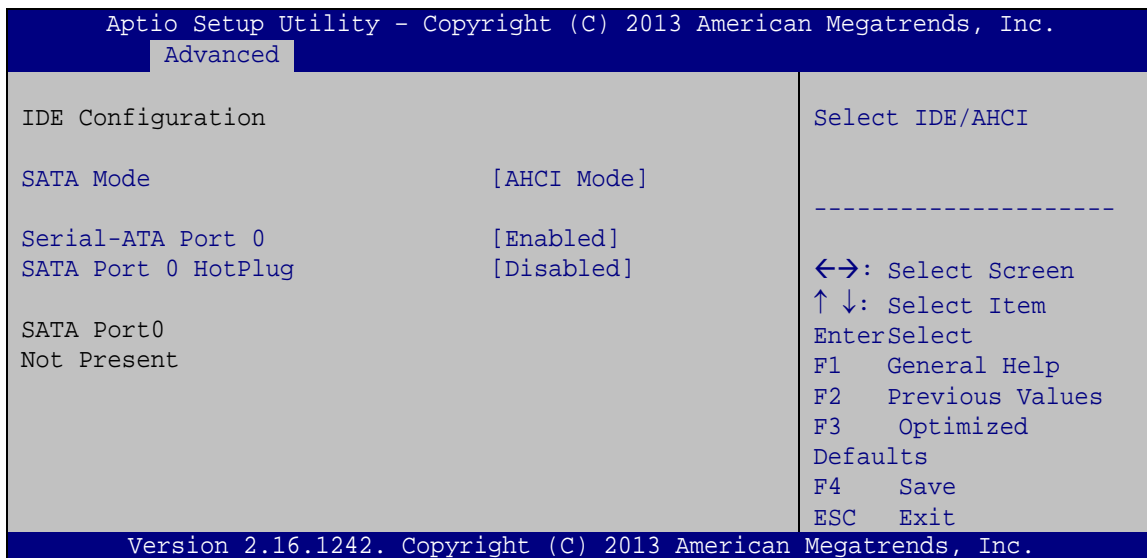

BIOS Menu 12: IDE Configuration

- ➔ SATA Mode [ACHI Mode]

Use the **SATA Mode** option to configure SATA devices as normal IDE devices.

- ➔ **IDE Mode** Configures SATA devices as normal IDE device.
- ➔ **ACHI Mode** **DEFAULT** Configures SATA devices as AHCI device.

- ➔ Serial-ATA Port 0 [Enabled]

Use the **Serial-ATA Port 0** option to enable or disable the SATA device.

- ➔ **Disabled** Disables the SATA device.
- ➔ **Enabled** **DEFAULT** Enables the SATA device.

➔ SATA Port 0 HotPlug [Disabled]

Use the **Serial-ATA Port 0 HotPlug** option to enable or disable the SATA device hot plug.

- ➔ **Disabled** Disables the SATA device hot plug.
- ➔ **Enabled** **DEFAULT** Enables the SATA device hot plug

5.3.8 USB Configuration

Use the **USB Configuration** menu (**BIOS Menu 13**) to read USB configuration information and configure the USB settings.

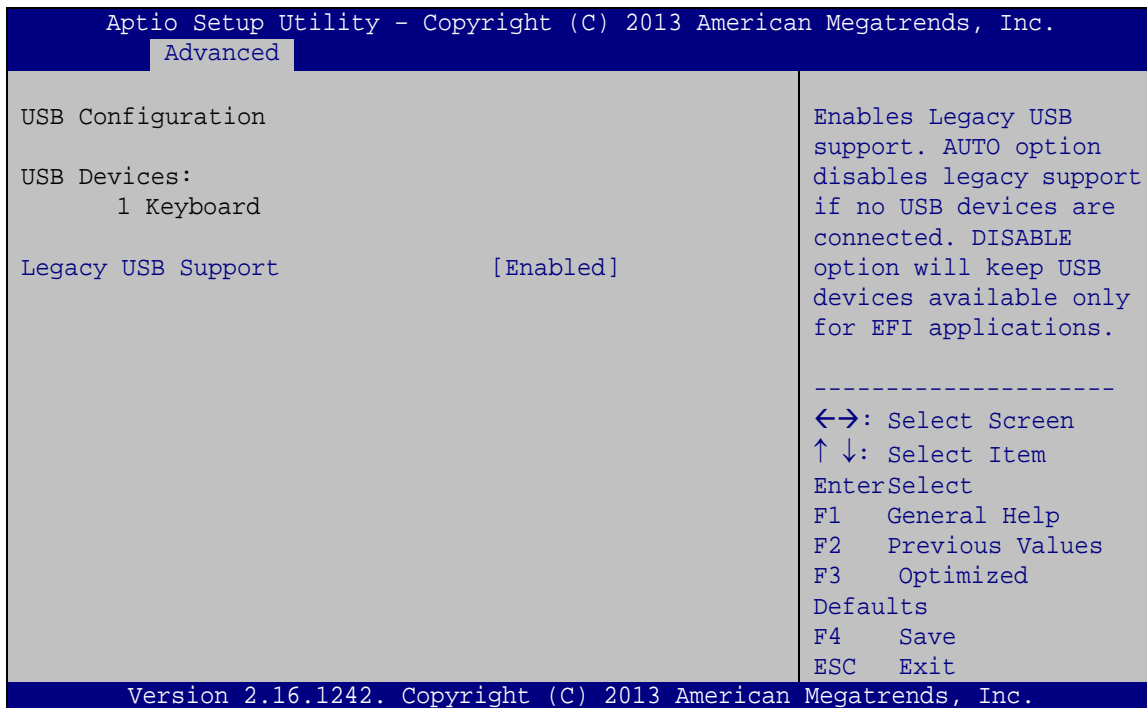

BIOS Menu 13: USB Configuration

➔ USB Devices

The **USB Devices Enabled** field lists the USB devices that are enabled on the system

➔ Legacy USB Support [Enabled]

Use the **Legacy USB Support** BIOS option to enable USB mouse and USB keyboard support. Normally if this option is not enabled, any attached USB mouse or USB keyboard

uIBX-230-BT Embedded System

does not become available until a USB compatible operating system is fully booted with all USB drivers loaded. When this option is enabled, any attached USB mouse or USB keyboard can control the system even when there is no USB driver loaded onto the system.

- ➔ **Enabled** **DEFAULT** Legacy USB support enabled
- ➔ **Disabled** Legacy USB support disabled
- ➔ **Auto** Legacy USB support disabled if no USB devices are connected

5.4 Chipset

Use the **Chipset** menu (**BIOS Menu 14**) to access the Northbridge and Southbridge configuration menus



WARNING!

Setting the wrong values for the Chipset BIOS selections in the Chipset BIOS menu may cause the system to malfunction.

```

Aptio Setup Utility - Copyright (C) 2013 American Megatrends, Inc.
Main   Advanced  Chipset  Security  Boot   Save & Exit
-----
> North Bridge
> South Bridge

North Bridge Parameters
-----
<=>: Select Screen
↑↓: Select Item
EnterSelect
+/-: Change Opt.
F1   General Help
F2   Previous Values
F3   Optimized Defaults
F4   Save & Exit
ESC  Exit

Version 2.16.1242. Copyright (C) 2013 American Megatrends, Inc.
    
```

BIOS Menu 14: Chipset

5.4.1 North Bridge Configuration

Use the **North Bridge Configuration** menu (**BIOS Menu 15**) to configure the Intel IGD settings.

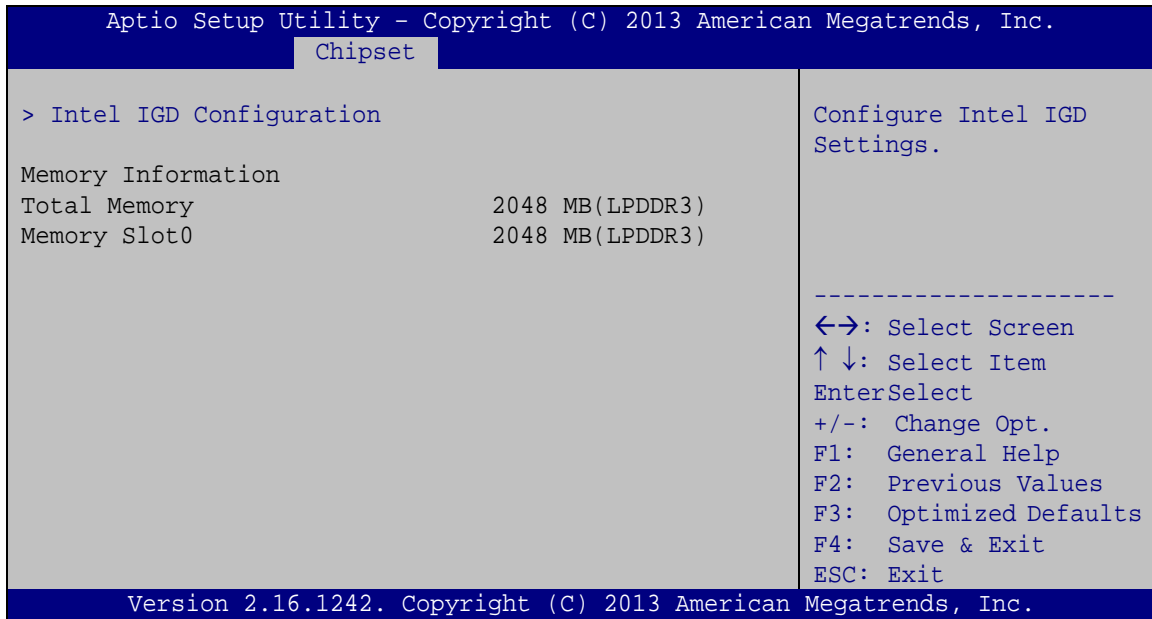

BIOS Menu 15: Northbridge Chipset Configuration

➔ Memory Information

The **Memory Information** lists a brief summary of the on-board memory. The fields in **Memory Information** cannot be changed.

5.4.1.1 Intel IGD Configuration

Use the **Intel IGD Configuration** menu (**BIOS Menu 16**) to configure the video device connected to the system.

uIBX-230-BT Embedded System

Aptio Setup Utility - Copyright (C) 2013 American Megatrends, Inc.		
Chipset		
DVMT Pre-Allocated	[256M]	Select DVMT 5.0 Pre-Allocated (Fixed) Graphics Memory size used by the Internal Graphics Device.
DVMT Total Gfx Mem	[Max]	
Primary IGFX Boot Display	[VBIOS Default]	

←→: Select Screen		
↑↓: Select Item		
Enter>Select		
+/-: Change Opt.		
F1: General Help		
F2: Previous Values		
F3: Optimized Defaults		
F4: Save & Exit		
ESC: Exit		
Version 2.16.1242. Copyright (C) 2013 American Megatrends, Inc.		

BIOS Menu 16: Integrated Graphics

→ DVMT Pre-Allocated [256MB]

Use the **DVMT Pre-Allocated** option to set the amount of system memory allocated to the integrated graphics processor when the system boots. The system memory allocated can then only be used as graphics memory, and is no longer available to applications or the operating system. Configuration options are listed below:

- 64M
- 128M
- 256M **Default**
- 512M

→ DVMT Total Gfx Mem [Max]

Use the **DVMT Total Gfx Mem** option to select DVMT5.0 total graphic memory size used by the internal graphic device. The following options are available:

- 128M
- 256M
- Max **Default**

➔ Primary IGFX Boot Display [VBIOS Default]

Use the **Primary IGFX Boot Display** option to select the display device used by the system when it boots. For dual display support, select “VBIOS Default.” Configuration options are listed below.

- VBIOS Default **DEFAULT**
- CRT
- DP Port

5.4.2 Southbridge Configuration

Use the **Southbridge Configuration** menu (**BIOS Menu 17**) to configure the Southbridge chipset.

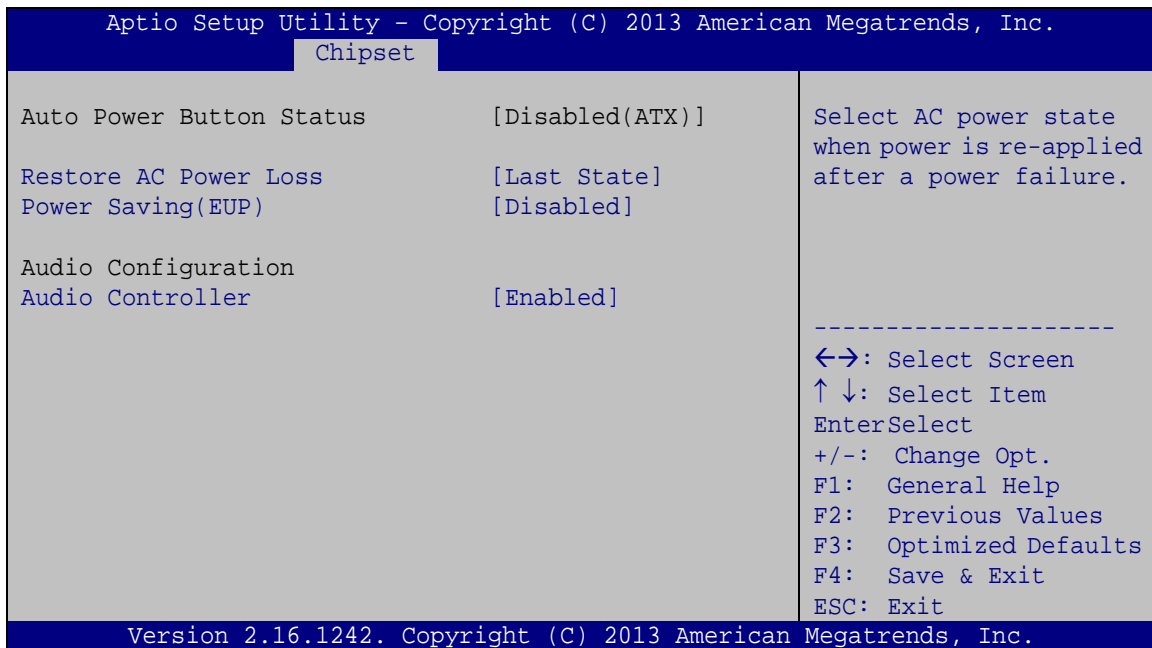

BIOS Menu 17: Southbridge Chipset Configuration

➔ Restore AC Power Loss [Last State]

Use the **Restore AC Power Loss** BIOS option to specify what state the system returns to if there is a sudden loss of power to the system.

- ➔ **Power Off** The system remains turned off

uIBX-230-BT Embedded System

- ➔ **Power On** The system turns on
- ➔ **Last State** **DEFAULT** The system returns to its previous state. If it was on, it turns itself on. If it was off, it remains off.

➔ Power Saving (EUP) [Disabled]

Use the **Power Saving (EUP)** option to enable or disable the power saving function.

- ➔ **Disabled** **DEFAULT** Power saving function is disabled.
- ➔ **Enabled** Power saving function is enabled. It will reduce power consumption when the system is off.

➔ Audio Controller [Enabled]

Use the **Audio Controller** option to enable or disable the High Definition Audio controller.

- ➔ **Disabled** The onboard High Definition Audio controller is disabled
- ➔ **Enabled** **DEFAULT** The onboard High Definition Audio controller is detected automatically and enabled

5.5 Security

Use the **Security** menu (**BIOS Menu 18**) to set system and user passwords.

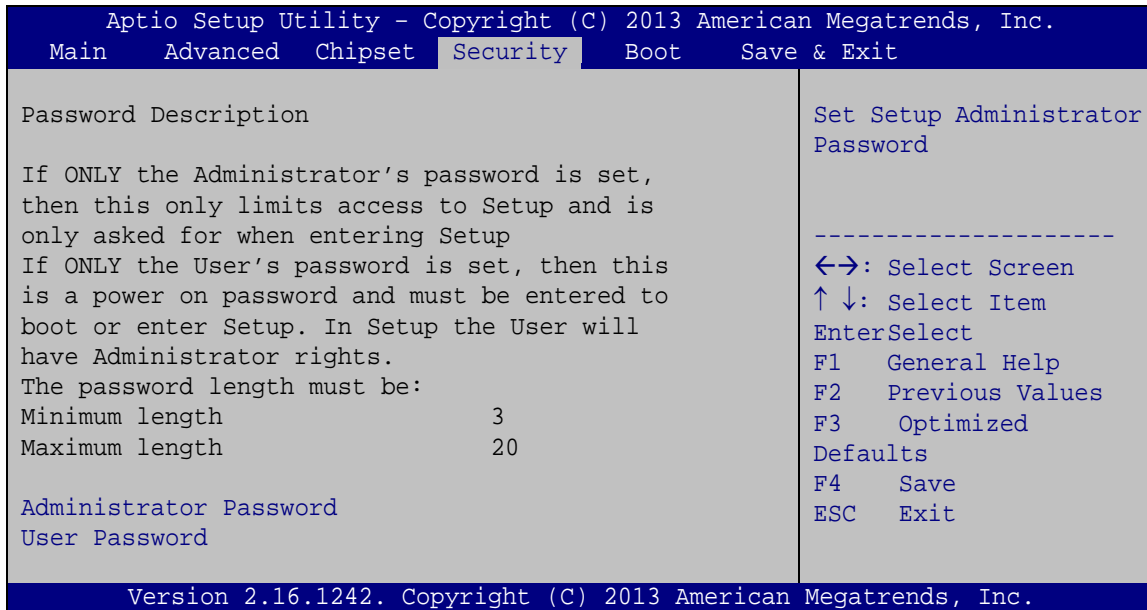

BIOS Menu 18: Security

➔ Administrator Password

Use the **Administrator Password** to set or change a administrator password.

➔ User Password

Use the **User Password** to set or change a user password.

5.6 Boot

Use the **Boot** menu (**BIOS Menu 19**) to configure system boot options.

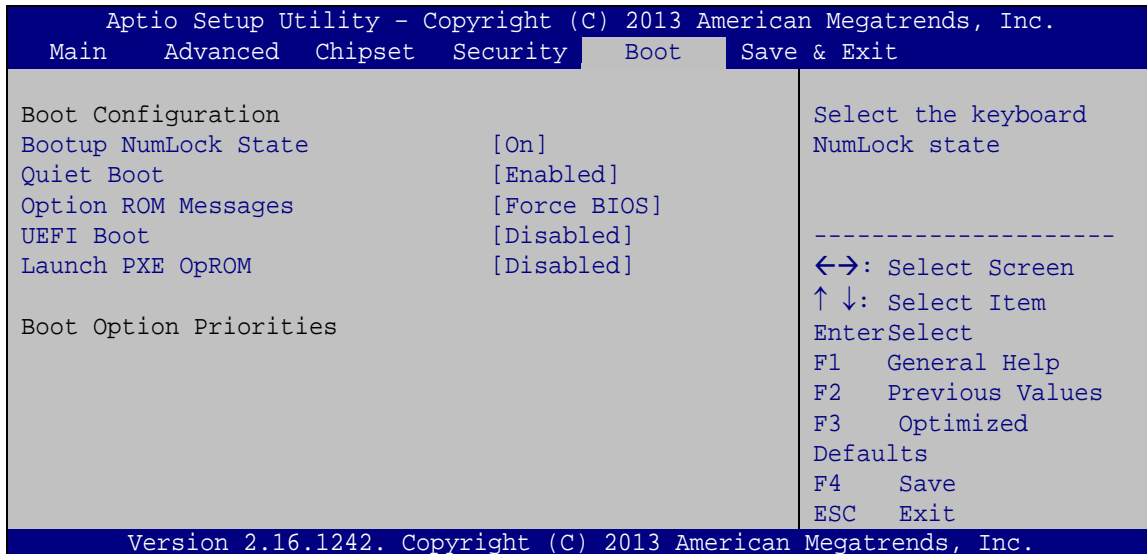

BIOS Menu 19: Boot

→ Bootup NumLock State [On]

Use the **Bootup NumLock State** BIOS option to specify if the number lock setting must be modified during boot up.

→ **On** **DEFAULT** Allows the Number Lock on the keyboard to be enabled automatically when the computer system boots up. This allows the immediate use of the 10-key numeric keypad located on the right side of the keyboard. To confirm this, the Number Lock LED light on the keyboard is lit.

→ **Off** Does not enable the keyboard Number Lock automatically. To use the 10-keys on the keyboard, press the Number Lock key located on the upper left-hand corner of the 10-key pad. The Number Lock LED on the keyboard lights up when the Number Lock is engaged.

→ Quiet Boot [Enabled]

Use the **Quiet Boot** BIOS option to select the screen display when the system boots.

- **Disabled** Normal POST messages displayed
- **Enabled** **DEFAULT** OEM Logo displayed instead of POST messages

→ Option ROM Messages [Force BIOS]

Use the **Option ROM Messages** option to set the Option ROM display mode.

- **Force BIOS** **DEFAULT** Sets display mode to force BIOS.
- **Keep Current** Sets display mode to current.

→ UEFI Boot [Disabled]

Use the **UEFI Boot** option to enable or disable to boot from the UEFI devices.

- **Enabled** Boot from UEFI devices is enabled.
- **Disabled** **DEFAULT** Boot from UEFI devices is disabled.

→ Launch PXE OpROM [Disabled]

Use the **Launch PXE OpROM** option to enable or disable boot option for legacy network devices.

- **Disabled** **DEFAULT** Ignore all PXE Option ROMs
- **Enabled** Load PXE Option ROMs.

→ Boot Option Priority

Use the **Boot Option Priority** function to set the system boot sequence from the available devices. The drive sequence also depends on the boot sequence in the individual device section.

uIBX-230-BT Embedded System

5.7 Exit

Use the **Exit** menu (**BIOS Menu 20**) to load default BIOS values, optimal failsafe values and to save configuration changes.

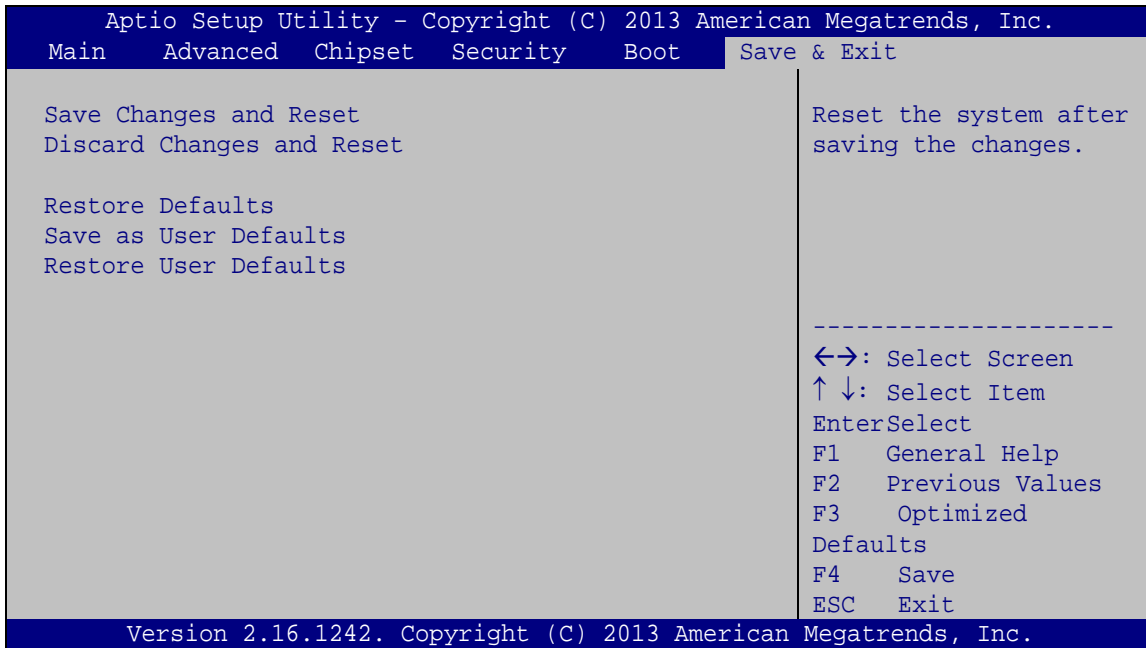
**BIOS Menu 20:Exit**

➔ Save Changes and Reset

Use the **Save Changes and Reset** option to save the changes made to the BIOS options and to exit the BIOS configuration setup program.

➔ Discard Changes and Reset

Use the **Discard Changes and Reset** option to exit the system without saving the changes made to the BIOS configuration setup program.

➔ Restore Defaults

Use the **Restore Defaults** option to load the optimal default values for each of the parameters on the Setup menus. **F3 key can be used for this operation.**

→ Save as User Defaults

Use the **Save as User Defaults** option to save the changes done so far as user defaults.

→ Restore User Defaults

Use the **Restore User Defaults** option to restore the user defaults to all the setup options.

Appendix

A

Safety Precautions

A.1 Safety Precautions



WARNING:

The precautions outlined in this appendix should be strictly followed. Failure to follow these precautions may result in permanent damage to the uIBX-230-BT.

Please follow the safety precautions outlined in the sections that follow:

A.1.1 General Safety Precautions

Please ensure the following safety precautions are adhered to at all times.

- ***Make sure the power is turned off and the power cord is disconnected*** when moving, installing or modifying the system.
- ***Do not apply voltage levels that exceed the specified voltage range.*** Doing so may cause fire and/or an electrical shock.
- ***Electric shocks can occur*** if opened while still powered on.
- ***Do not drop or insert any objects*** into the ventilation openings.
- ***If considerable amounts of dust, water, or fluids enter the system***, turn off the power supply immediately, unplug the power cord, and contact the system vendor.
- **DO NOT:**
 - Drop the system against a hard surface.
 - In a site where the ambient temperature exceeds the rated temperature

A.1.2 Anti-static Precautions



WARNING:

Failure to take ESD precautions during the installation of the uIBX-230-BT may result in permanent damage to the uIBX-230-BT and severe injury to the user.

uIBX-230-BT Embedded System

Electrostatic discharge (ESD) can cause serious damage to electronic components, including the uIBX-230-BT. Dry climates are especially susceptible to ESD. It is therefore critical that whenever the uIBX-230-BT is opened and any of the electrical components are handled, the following anti-static precautions are strictly adhered to.

- **Wear an anti-static wristband:** Wearing a simple anti-static wristband can help to prevent ESD from damaging any electrical component.
- **Self-grounding:** Before handling any electrical component, touch any grounded conducting material. During the time the electrical component is handled, frequently touch any conducting materials that are connected to the ground.
- **Use an anti-static pad:** When configuring or working with an electrical component, place it on an anti-static pad. This reduces the possibility of ESD damage.
- **Only handle the edges of the electrical component:** When handling the electrical component, hold the electrical component by its edges.

A.1.3 Product Disposal



CAUTION:

Risk of explosion if battery is replaced by an incorrect type. Only certified engineers should replace the on-board battery.

Dispose of used batteries according to instructions and local regulations.

-
- Outside the European Union - If you wish to dispose of used electrical and electronic products outside the European Union, please contact your local authority so as to comply with the correct disposal method.
 - Within the European Union:

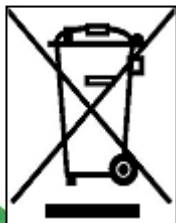

EU-wide legislation, as implemented in each Member State, requires that waste electrical and electronic products carrying the mark (left) must be disposed of separately from normal household waste. This includes

monitors and electrical accessories, such as signal cables or power cords. When you need to dispose of your display products, please follow the guidance of your local authority, or ask the shop where you purchased the product. The mark on electrical and electronic products only applies to the current European Union Member States.

Please follow the national guidelines for electrical and electronic product disposal.

A.2 Maintenance and Cleaning Precautions

When maintaining or cleaning the uIBX-230-BT, please follow the guidelines below.

A.2.1 Maintenance and Cleaning

Prior to cleaning any part or component of the uIBX-230-BT, please read the details below.

- The interior of the uIBX-230-BT does not require cleaning. Keep fluids away from the uIBX-230-BT interior.
- Be cautious of all small removable components when vacuuming the uIBX-230-BT.
- Turn the uIBX-230-BT off before cleaning the uIBX-230-BT.
- Never drop any objects or liquids through the openings of the uIBX-230-BT.
- Be cautious of any possible allergic reactions to solvents or chemicals used when cleaning the uIBX-230-BT.
- Avoid eating, drinking and smoking within vicinity of the uIBX-230-BT.

A.2.2 Cleaning Tools

Some components in the uIBX-230-BT may only be cleaned using a product specifically designed for the purpose. In such case, the product will be explicitly mentioned in the cleaning tips. Below is a list of items to use when cleaning the uIBX-230-BT.

- **Cloth** – Although paper towels or tissues can be used, a soft, clean piece of cloth is recommended when cleaning the uIBX-230-BT.
- **Water or rubbing alcohol** – A cloth moistened with water or rubbing alcohol can be used to clean the uIBX-230-BT.
- **Using solvents** – The use of solvents is not recommended when cleaning the uIBX-230-BT as they may damage the plastic parts.

uIBX-230-BT Embedded System

- **Vacuum cleaner** – Using a vacuum specifically designed for computers is one of the best methods of cleaning the uIBX-230-BT. Dust and dirt can restrict the airflow in the uIBX-230-BT and cause its circuitry to corrode.
- **Cotton swabs** - Cotton swabs moistened with rubbing alcohol or water are excellent tools for wiping hard to reach areas.
- **Foam swabs** - Whenever possible, it is best to use lint free swabs such as foam swabs for cleaning.

Appendix

B

BIOS Menu Options

uIBX-230-BT Embedded System

→ System Date [xx/xx/xx]	48
→ System Time [xx:xx:xx]	48
→ ACPI Sleep State [S3 only (Suspend to RAM)]	49
→ Serial Port [Enabled].....	51
→ Change Settings [Auto]	51
→ PC Health Status	52
→ CPU Smart Fan control [Auto PWM Mode].....	53
→ Temperature of Off [75]	53
→ Temperature of Start [80]	54
→ Start PWM [30].....	54
→ Slope (Duty Cycle) [4].....	55
→ Wake system with Fixed Time [Disabled].....	56
→ Console Redirection [Disabled].....	57
→ Terminal Type [ANSI].....	58
→ Bits per second [115200].....	58
→ Data Bits [8]	59
→ Parity [None].....	59
→ Stop Bits [1].....	59
→ Intel® Virtualization Technology [Disabled].....	60
→ EIST [Enabled].....	60
→ SATA Mode [ACHI Mode]	61
→ Serial-ATA Port 0 [Enabled].....	61
→ SATA Port 0 HotPlug [Disabled].....	62
→ USB Devices	62
→ Legacy USB Support [Enabled].....	62
→ Memory Information	64
→ DVMT Pre-Allocated [256MB].....	65
→ DVMT Total Gfx Mem [Max].....	65
→ Primary IGFX Boot Display [VBIOS Default]	66
→ Restore AC Power Loss [Last State]	66
→ Power Saving (EUP) [Disabled]	67
→ Audio Controller [Enabled]	67
→ Administrator Password	68
→ User Password	68

→ Bootup NumLock State [On].....	69
→ Quiet Boot [Enabled]	70
→ Option ROM Messages [Force BIOS].....	70
→ UEFI Boot [Disabled]	70
→ Launch PXE OpROM [Disabled]	70
→ Boot Option Priority.....	70
→ Save Changes and Reset	71
→ Discard Changes and Reset	71
→ Restore Defaults	71
→ Save as User Defaults	72
→ Restore User Defaults	72

Appendix

D

Watchdog Timer



NOTE:

The following discussion applies to DOS environment. IEI support is contacted or the IEI website visited for specific drivers for more sophisticated operating systems, e.g., Windows and Linux.

The Watchdog Timer is provided to ensure that standalone systems can always recover from catastrophic conditions that cause the CPU to crash. This condition may have occurred by external EMI or a software bug. When the CPU stops working correctly, Watchdog Timer either performs a hardware reset (cold boot) or a Non-Maskable Interrupt (NMI) to bring the system back to a known state.

A BIOS function call (INT 15H) is used to control the Watchdog Timer:

INT 15H:

AH – 6FH Sub-function:	
AL – 2:	Sets the Watchdog Timer's period.
BL:	Time-out value (Its unit-second is dependent on the item "Watchdog Timer unit select" in CMOS setup).

Table C-1: AH-6FH Sub-function

Call sub-function 2 to set the time-out period of Watchdog Timer first. If the time-out value is not zero, the Watchdog Timer starts counting down. While the timer value reaches zero, the system resets. To ensure that this reset condition does not occur, calling sub-function 2 must periodically refresh the Watchdog Timer. However, the Watchdog timer is disabled if the time-out value is set to zero.

A tolerance of at least 10% must be maintained to avoid unknown routines within the operating system (DOS), such as disk I/O that can be very time-consuming.

**NOTE:**

When exiting a program it is necessary to disable the Watchdog Timer, otherwise the system resets.

Example program:

```

; INITIAL TIMER PERIOD COUNTER
;
W_LOOP:

    MOV     AX, 6F02H      ;setting the time-out value
    MOV     BL, 05        ;time-out value is 5 seconds
    INT     15H

;
; ADD THE APPLICATION PROGRAM HERE
;

    CMP     EXIT_AP, 1    ;is the application over?
    JNE     W_LOOP       ;No, restart the application

    MOV     AX, 6F02H    ;disable Watchdog Timer
    MOV     BL, 0        ;
    INT     15H

;
; EXIT ;

```

Appendix

E

Hazardous Materials Disclosure

D.1 Hazardous Materials Disclosure Table for IPB Products Certified as RoHS Compliant Under 2002/95/EC Without Mercury

The details provided in this appendix are to ensure that the product is compliant with the Peoples Republic of China (China) RoHS standards. The table below acknowledges the presences of small quantities of certain materials in the product, and is applicable to China RoHS only.

A label will be placed on each product to indicate the estimated “Environmentally Friendly Use Period” (EFUP). This is an estimate of the number of years that these substances would “not leak out or undergo abrupt change.” This product may contain replaceable sub-assemblies/components which have a shorter EFUP such as batteries and lamps. These components will be separately marked.

Please refer to the table on the next page.

Part Name	Toxic or Hazardous Substances and Elements					
	Lead (Pb)	Mercury (Hg)	Cadmium (Cd)	Hexavalent Chromium (CR(VI))	Polybrominated Biphenyls (PBB)	Polybrominated Diphenyl Ethers (PBDE)
Housing	O	O	O	O	O	O
Display	O	O	O	O	O	O
Printed Circuit Board	O	O	O	O	O	O
Metal Fasteners	O	O	O	O	O	O
Cable Assembly	O	O	O	O	O	O
Fan Assembly	O	O	O	O	O	O
Power Supply Assemblies	O	O	O	O	O	O
Battery	O	O	O	O	O	O

O: This toxic or hazardous substance is contained in all of the homogeneous materials for the part is below the limit requirement in SJ/T11363-2006

X: This toxic or hazardous substance is contained in at least one of the homogeneous materials for this part is above the limit requirement in SJ/T11363-2006

uIBX-230-BT Embedded System

此附件旨在确保本产品符合中国 RoHS 标准。以下表格标示此产品中某有毒物质的含量符合中国 RoHS 标准规定的限量要求。

本产品上会附有“环境友好使用期限”的标签，此期限是估算这些物质“不会有泄漏或突变”的年限。本产品可能包含有较短的环境友好使用期限的可替换元件，像是电池或灯管，这些元件将会单独标示出来。

部件名称	有毒有害物质或元素					
	铅 (Pb)	汞 (Hg)	镉 (Cd)	六价铬 (CR(VI))	多溴联苯 (PBB)	多溴二苯 醚 (PBDE)
壳体	O	O	O	O	O	O
显示	O	O	O	O	O	O
印刷电路板	O	O	O	O	O	O
金属螺帽	O	O	O	O	O	O
电缆组装	O	O	O	O	O	O
风扇组装	O	O	O	O	O	O
电力供应组装	O	O	O	O	O	O
电池	O	O	O	O	O	O

O: 表示该有毒有害物质在该部件所有物质材料中的含量均在 SJ/T11363-2006 标准规定的限量要求以下。
X: 表示该有毒有害物质至少在该部件的某一均质材料中的含量超出 SJ/T11363-2006 标准规定的限量要求。